



mySewnet™ Embroidery

Reference Guide

Mac®

The software to which this Reference Guide relates is subject to change without notice. All efforts have been made to ensure the accuracy of the contents of this Reference Guide.

The software described in this book is furnished under a license agreement and may be used only in accordance with the terms of the agreement.

Permission is hereby granted to the licensee of the software to which this guide is related to reproduce and distribute copies of this guide for nonprofit educational purposes. The copyright statement on this page must be included on any copy of this work.

Product names mentioned in this guide may be trademarks or registered trademarks of their respective companies and are hereby acknowledged.

mySewnet, VIKING, PFAFF, PREMIER+ and 6D are trademarks of Singer Sourcing Limited LLC

HUSQVARNA is the trademark of Husqvarna AB.

All trademarks are used under license by Singer Sourcing Limited LLC.

**© 2022 Singer Sourcing Limited LLC
All rights reserved. (Version D)**

Contents

1 Chapter 1: Welcome to mySewnet™ Embroidery

7 Chapter 2: Tools and Techniques

7 Welcome Screen

8 The mySewnet™ Embroidery Window

9 The Toolbar

9 FilmStrip

15 Keyboard Shortcuts and Shortcut Menus

17 mySewnet™ Embroidery Terms and Conventions

22 Hoop Selection

24 Chapter 3: Managing Embroideries

24 New

24 Opening Embroideries

27 Edit Design

27 Notes and Settings

29 Combine

30 Fix as Stitches

30 Save Embroideries

33 Export

42 Sending Embroideries

46 Working with Protected Designs

48 Revert To

49 Chapter 4: Viewing Embroideries

49 View Mode

50 Grid

51 Zooming In or Out

53 Backgrounds

56 Background Assistant

57 Choose Background

58 Load Background

59 Choose Picture

61 Rotate and Crop Picture

64 Rotate and Crop Picture - Fabric

66 Set Size

67 Set Background Name

70 Life View

73 Design Player

77 Chapter 5: Editing Colors

- 77 Design Window
- 78 Color Select
- 83 Colors Window
- 84 Color Tone
- 86 ColorSort

87 Chapter 6: Modifying Embroideries

- 87 Selecting Embroideries
- 91 Grouping Selected Embroideries
- 96 Move
- 96 Resize and Scale
- 97 Rotate
- 98 Rotate 45
- 99 Modify Design
- 100 Flip Vertical and Horizontal
- 100 Aligning Embroideries
- 102 Layout Order
- 103 Encore
- 104 About Encore
- 112 Endless
- 122 Cut, Copy, Paste and Duplicate Selected
- 123 Delete
- 124 Undo and Redo

125 Chapter 7: Modifying Stitches and Blocks

- 125 Modify Window
- 127 Viewing Embroideries in the Modify Window
- 128 Select Stitches
- 129 Box Select
- 130 Point Select
- 131 Freehand Select
- 131 Select All Visible
- 132 Modify Block
- 133 View Selected Colors
- 134 Display All
- 134 View a Range of Stitches
- 135 Modify Stitches
- 138 Edit and Add Stitches
- 139 Inserting Tie Stitches

141 Chapter 8: Split Project

- 141 Using the Split Project Assistant
- 143 Split Embroidery

- 147 Save Embroidery
- 149 Print Options
- 150 Stitch Out and Align Split Project Sections
- 153 Split Project Examples

156 Chapter 9: Embellishments

- 156 Embellish Window
- 158 Drawing and Placing Embellishments
- 160 Ribbon
- 163 Yarn
- 166 String of Beads
- 169 Decoration
- 172 Editing Embellishments
- 174 Decoration Selection
- 176 Using and Adjusting Decorations

184 Chapter 10: Appliqué

- 184 Creating Appliqué Areas
- 185 View and Adjust Appliqué Pieces
- 195 Appliqué Selection
- 197 Background Picture Viewer
- 198 Load Picture Assistant
- 202 Appliqué Options

204 Chapter 11: ExpressDesign Assistant

- 205 ExpressDesign into Hoop
- 206 ExpressDesign into Rectangle
- 206 Choosing and Optimizing Pictures for the ExpressDesign Assistant
- 210 Choose Design Type
- 212 Choose Picture
- 214 Rotate and Crop Picture
- 216 Design Size
- 217 Choose Thread Colors
- 222 Fabric and Stitch Options
- 224 Outline Finder and Expander
- 226 MonochromeThreshold
- 227 Express Trace Options
- 230 Express Border Options
- 234 ExpressDesign Assistant Examples

239 Chapter 12: Quilt Block Assistant

- 239 Quilt Block Assistant
- 240 Select Quilt Block Style
- 241 Select Size
- 243 Load Embroidery

245	Adjust Embroidery
247	Select Shape
249	Select Fill Pattern
252	Quilt Block Assistant Examples
261	Chapter 13: Project-in-the-Hoop Assistant
261	Project-in-the-Hoop Assistant
264	Chapter 14: Word Sculpt Assistant
264	Word Sculpt Assistant
265	Select Outline
266	Select Words
269	Word Sculpt Assistant Examples
271	Chapter 15: Spiro Assistant
271	Using the Spiro Assistant
277	Chapter 16: PhotoStitch Assistant
278	PhotoStitch into Hoop
279	PhotoStitch into Rectangle
279	Selecting and Editing Pictures
289	Choose Embroidery Type
291	Choose Picture
293	Rotate and Crop Picture
295	Remove Background
299	Picture Options
302	Design Size
303	Choose Thread Colors
306	PhotoStitch Embroidery Options
308	Color Tile Options
311	Linear Embroidery Options
314	Chapter 17: Family Tree Assistant
314	Family Tree Assistant
317	Family
323	Lettering
326	Frame
328	Connectors
330	Create a Family Tree Embroidery
333	Chapter 18: ExpressMonogram Assistant
333	ExpressMonogram Assistant
338	Monogram
340	Full Letter
343	Small Letter

- 346 Border
- 348 Create a Monogram with a Border
- 352 Create a Two Letter Monogram

355 Chapter 19: Creating Lettering

- 359 About Fonts
- 364 About Lettering
- 365 Letter Options
- 366 Lettering Shapes
- 382 Font Manager
- 385 Import Font from Embroideries
- 391 Lettering Examples
- 395 Edit Lettering
- 396 Letter Properties
- 400 Fixing Lettering as an Embroidery

401 Chapter 20: QuickFont

- 401 How to Create a Font
- 404 Select Font
- 410 Set Stitch Options
- 425 Output Options
- 427 Create a Pattern Fill Font
- 430 Font Guidelines

433 Chapter 21: Name Changer

- 433 Using Name Changer

438 Chapter 22: Creating SuperDesigns

- 439 About SuperDesigns
- 441 Edit SuperDesigns
- 442 SuperDesign Properties
- 443 Fixing SuperDesigns as Embroideries

445 Chapter 23: Frames, Borders & Underlines

- 445 Creating Frames, Borders and Underlines
- 448 Frame Selection
- 451 Edit Frames
- 452 Frame Properties
- 453 Fixing Frames and Flourishes as Embroideries
- 453 Frames Examples
- 457 Creating Borders
- 459 Creating Motif Underlines

462 Chapter 24: Choosing Stitch Properties

- 462 Stitch Type

463	Pattern Fill
466	Gradient
470	Motif Fill
473	Crosshatch Fill
476	Curved Crosshatch Fill
479	MultiWave Fill
482	Echo Fill
484	Shape Fill
486	Radial Fill
487	Spiral Fill
490	QuiltStipple Fill
492	Contour Fill
493	Satin Area
494	Satin Column
496	Feathered Satin
497	Richelieu Bars
499	Tapered Motif
501	Line Types
501	Running Stitch
501	Double Stitch
502	Double Zigzag
503	Triple Stitch
504	Satin Line
506	Motif Line
509	Stitch Features
509	Motif Selection
511	Fill and Satin Patterns

515 Chapter 25: Preferences

517 Chapter 26: Printing

517	Print
-----	-------

521 Chapter 27: Troubleshooting

521	Error Messages
530	Other Topics

540 Chapter 28: Quick Reference Guide

540	Menus
552	Toolbar
554	Control Panel
557	FilmStrip
558	Keyboard Shortcuts
559	Character Sets

Welcome to mySewnet™ Embroidery

Use mySewnet™ Embroidery to adjust, modify, personalize and combine embroidery designs, frames and flourishes, and add appliqué and decorations.

To get started with mySewnet™ Embroidery, open it and create embroidery projects using lettering and SuperDesigns, or open an existing embroidery and modify it. Personalize your embroideries in true 3D in a real hoop. Rotate your embroideries to any degree, mirror them from side to side or end to end and scale or resize your embroideries. Use the FilmStrip to view your designs, and change their order. Adjust an unlimited number of designs and lettering 'side by side' in multiple windows.



Adjust the colors to the thread shades from your preferred manufacturer, or even create your own threads, then combine with lettering or shapes. Select multiple designs and move them as a unit, or use Group to save the selected embroideries as a group. Cut, copy or paste and duplicate embroideries between mySewnet™ Embroidery Software apps. ColorSort when designing or Exporting to intelligently re-sort the color order of a design to reduce the number of thread changes.



Use 'Encore' to repeat embroideries in a circle, in 8 line and 50 shape options, or around the hoop. Use the Endless function to make endless embroideries for any hoop. Add appliqué and decorations to your designs.

Add multi-line lettering with your choice of 35 lettering shapes and flexibility to resize and reshape words, and space letters individually. Select machine motif stitches visually to create new designs or embellish existing ones, or add

SuperDesigns. Surround monograms, names or any design with frames and flourishes or an automatic border. Adjust the fill, satin and line settings for many fonts and SuperDesigns.

Use Design Player  to play through an embroidery, and Life View  to view the embroidery in real-world perspective with the desired export options. Save your project with its design parts kept separate in multipart .vp4 format, and Export in the desired format according to the chosen options to optimize for sewing.

Create designs automatically from clipart or photos with the ExpressDesign Assistant and PhotoStitch Assistant. Create monograms, quilt blocks, word sculptures, in-the-hoop projects, spiral designs and fonts with the ExpressMonogram Assistant, Quilt Block Assistant, Word Sculpt Assistant, Project-in-the-Hoop Assistant, Spiro and QuickFont, and split large embroidery projects into sections for stitching out with the Split Project. Finally, view your project on your desired background.

Use 2D editing in the Modify window to alter individual stitches or whole blocks of stitches, even insert new stitches. Manage colors in your embroideries: move colors up or down, merge color blocks and insert color changes.

Move between mySewnet™ Embroidery Software apps using Edit Design to edit and adjust the selected part of your project in another app, or open a different app from the Welcome page or Create window.

- Open mySewnet™ Embroidery by clicking its icon in the Launchpad, or by double-clicking its icon in the Finder. The mySewnet™ Embroidery work area appears.

Assistants

QuickFont

Use QuickFont  to create new fonts for mySewnet™ Embroidery from most TrueType® or OpenType® fonts on your computer.

Word Sculpt Assistant

Use the Word Sculpt Assistant  to create a word design automatically using your choice of outline, words, and fonts. Create your own outline, or adjust a system outline.

Name Changer

Use Name Changer  to create a series of embroideries with varied lettering automatically from a template that you designed.

Spiro

Use Spiro  to create intricate spiral designs in multiple colors, using Running, Double or Triple stitch lines.

ExpressDesign Assistant

Use the ExpressDesign Assistant  to automatically create embroideries from a picture, either to fit the current hoop or to fit an area you select. Choose from three design types:

Express Embroidery



Create a standard embroidery using satin, fill areas and outlining.

Express Trace

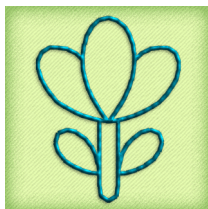

Trace outlines in a picture to create, for example, redwork, quilt stencils and so on.

Express Border

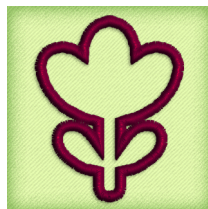

Create satin line, appliqué, running stitch, triple stitch or motifs around the edges of solid color areas in the picture.

ExpressMonogram Assistant

Use the ExpressMonogram Assistant  to create a monogram of up to three letters from a set of initials, choosing a font style, thread color, shape and size. If desired, add a border.

PhotoStitch Assistant

Use the PhotoStitch Assistant  to create unique embroideries automatically from your own photos, to fit the hoop or selected area.

Color PhotoStitch Embroidery



Create an embroidery from a color photo, using multiple threads for a full color result.

Sepia PhotoStitch Embroidery



Create a sepia embroidery from a photo to give a heritage look, similar to old photos.

Monochrome PhotoStitch Embroidery



Create a grayscale embroidery from a black and white photo.

Color Tile PhotoStitch Embroidery



Create an embroidery from a color photo, generating small blocks of stitches with a tiled effect.

Linear PhotoStitch Embroidery

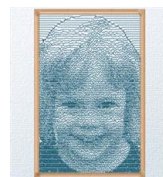

Create a single thread embroidery from a photo, generating a linear pattern of stitches, or a Maze or Spiral effect.

Project-in-the-Hoop Assistant

Use the Project-in-the-Hoop Assistant  to create an in-the-hoop design using your choice of project type, style and dimensions.

Family Tree Assistant

Use the Family Tree Assistant  to create an embroidery chart of your family's history quickly and easily.

Quilt Block Assistant

Use the Quilt Block Assistant  to create a filled or outline quilt block automatically. Place a quilting fill around an embroidery!

Filled Quilt Block;
Inner Embroidery

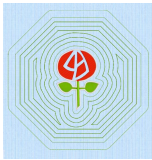

Create a filled quilt block surrounding an embroidery.

Outline Quilt Block; Filled Inner Shape

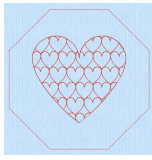

Create an unfilled quilt block containing a filled shape.

Filled Quilt Block; Outline Inner Shape

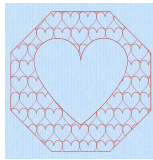

Create a quilt block with an unfilled shape, surrounded by a fill.

Filled Quilt Block; No Inner Shape

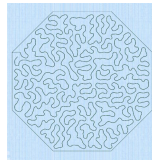

Fill a quilt block with a motif or pattern.

Outline Quilt Block; No Inner Shape

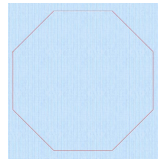

Create a quilt block without any internal shape or fill.

Endless

Use Endless  to create a continuous embroidery sequence.

Split Project

Use Split Project  to split your embroidery automatically for your preferred hoop.

Further Information

Reference Guide

The Reference Guide shows how to start the app and provides a quick tour of the main screen. The Reference Guide is supplied in PDF format , ready for printing, and contains full reference information.

Help

The integrated help contains full reference information. Click the Help button . Where available, a help topic appears that is relevant to the selected item. Alternatively, use the Help menu.

Viewing and Printing PDF Guides

To find all the Reference Guides for your mySewnet™ Embroidery Software, go to the mySewnet™ Guides page, linked to from download.mysewnet.com. Select the desired PDF guide.

Note: To view and print the PDF Guides, you may use Preview which is included in your Mac OS®.

Readme

The most up-to-date details about the mySewnet™ Embroidery Software are in the Readme.rtf file available when you install your mySewnet™ Embroidery Software.

Sample Files

Samples are provided for your use. Download the sample files from the Downloads page: download.mysewnet.com. Copy the samples folder to the folder of your choice.

Note: For the exercises in this manual, the mySewnet folder is used.

About mySewnet™ Embroidery

Access via the mySewnet™ Embroidery menu. The version number of mySewnet™ Embroidery is given here. You will need this if you contact technical support at any time.

Starting mySewnet™ Embroidery

- Click the mySewnet™ Embroidery icon  in the Launchpad.
- Double-click the mySewnet™ Embroidery icon  in the Finder.

Close a Document

- Use the red close button  at the top left.
- Choose File > Close.
- Press **⌘W**



A saved document is autosaved as it closes. If the document has not been saved, the Save on Close dialog will appear. See “Save On Close” on page 31.

Close All

To close all documents:

- Choose File > **⌘** > Close.
- Press **⌘⌘W**

Minimize and Maximize

- Use the yellow minimize button  at the top left to minimize the current window.
- Use the green zoom button  at the top left to switch between a larger and smaller window size.

Quit mySewnet™ Embroidery

When you quit mySewnet™ Embroidery the open windows are remembered for when the program is next opened.

To quit mySewnet™ Embroidery

- Choose mySewnet™ Embroidery > Quit mySewnet™ Embroidery.
- Press ⌘Q

Get familiar with the tools you use to create embroideries with mySewnet™ Embroidery.

Each embroidery project that you create with mySewnet™ Embroidery is an individual document.

Welcome Screen

The first time you open mySewnet™ Embroidery (by clicking its icon in the Launchpad or by double-clicking its icon in the Finder), the mySewnet™ Embroidery Welcome Screen appears.

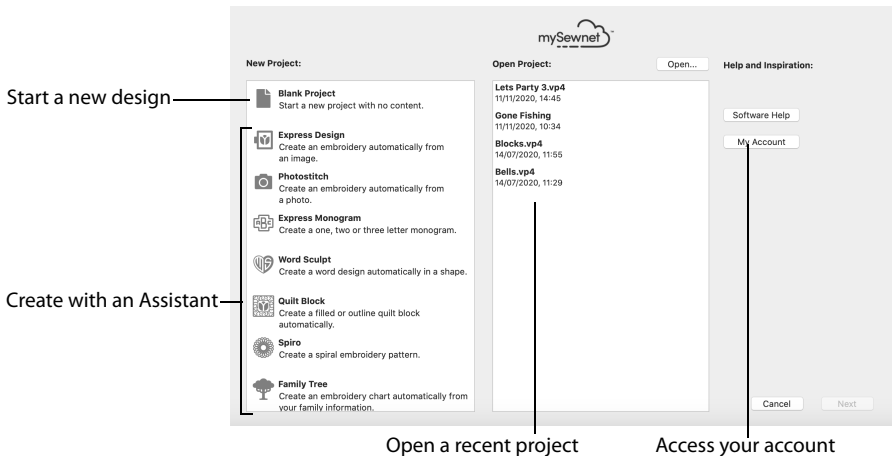

Note: The Welcome Screen also appears when you click New on the File menu.

In the Welcome Screen, start a new design from a blank screen, open an existing design, create a design with one of the Assistants, or use the mySewnet™ Cross Stitch or mySewnet™ Digitizing modules.

Note: When you select Blank Project and click Next, the Hoop Selection dialog opens for you to choose a hoop.

The Work Area

Use Blank Project, or click Cancel to open the work area. This is where you can create and edit embroideries. It is surrounded by the selected hoop.



The mySewnet™ Embroidery Window

Menu bar

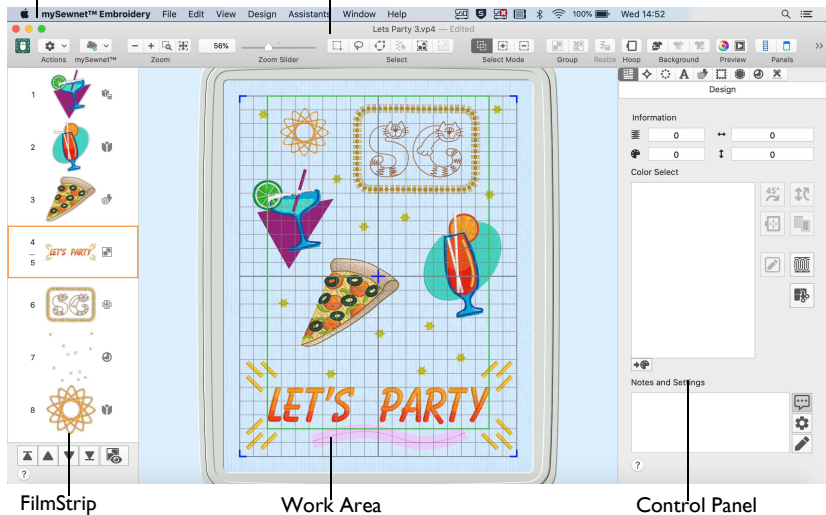
Toolbar: customize it to show the tools you use frequently



Showing and Hiding Tools

- The toolbar gives quick access to the tools needed to create and edit your embroidery project. To show or hide the toolbar, choose View > Show Toolbar, or View > Hide Toolbar ($\backslash \text{⌘} T$).
- The Control Panel gives access to the tools needed to edit your embroidery. To show the Control Panel, choose View > Show Control Panel ($\text{⌘} /$), or click .
- The FilmStrip enables you to view the stitchout order, and change the sequence. To show the FilmStrip, choose View > Show FilmStrip, or click .
- To load embroideries use File > Insert or File > Open. See “Insert Embroideries” on page 11.

The Toolbar

The mySewnet™ Embroidery toolbar gives one-click access to many of the features you will use as you work in mySewnet™ Embroidery. You can add, remove, or rearrange toolbar buttons as desired.

The default set of toolbar buttons is shown below.

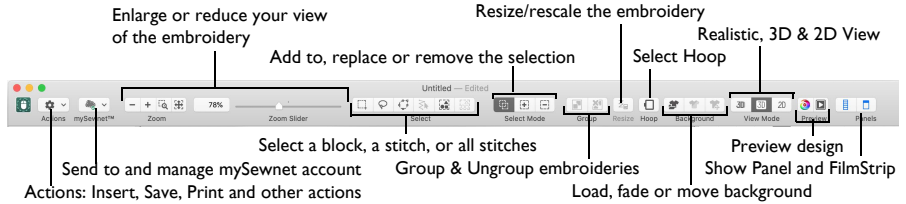

To Customize the Toolbar

- 1 Choose View > Customize Toolbar. Alternatively, Control-click in the toolbar and choose Customize Toolbar.
- 2 Make changes as desired: drag items to add or remove them, to return to the defaults drag the default set, choose an icon/text type from the Show menu, and select the size.
- 3 Click Done.



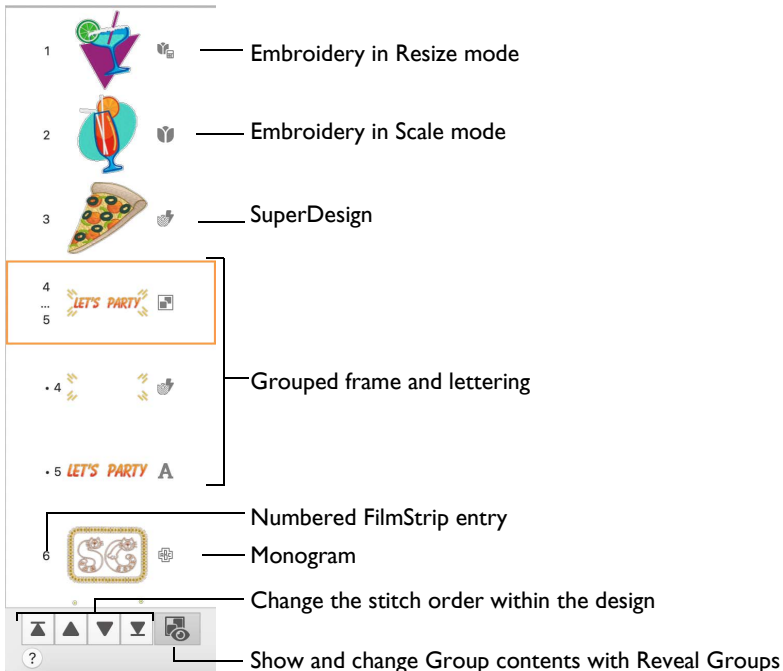







FilmStrip



Use the FilmStrip to view and select the designs in the embroidery, and to change the stitch order for those designs.





A design selected in the FilmStrip becomes selected in the work area.

Note: The FilmStrip is not visible when the Modify tab is selected.

The design types shown in the FilmStrip are: Embroidery in Resize mode ; Embroidery in Scale mode , SuperDesign , Lettering **A**, Decorations , Ribbon , Monograms , Library designs  & , Digitized designs  and Alignment Stitches . Designs within a Group are indented.

To learn how to	Go to
Resize or Scale an embroidery	See “Resize and Scale” on page 96.
Create SuperDesigns	See “Creating SuperDesigns” on page 438.
Create Lettering	See “Creating Lettering” on page 355.
Create Decorations and Ribbon	See “Embellishments” on page 156.
Work with Library designs	See “Working with Protected Designs” on page 46.
Create Frames	See “Creating Frames, Borders and Underlines” on page 445.
Work with Groups	See “Grouping Selected Embroideries” on page 91.
Create monograms with the assistant	See “ExpressMonogram Assistant” on page 333.
Change the order of the designs	See “Layout Order” on page 102.

Moving items within the FilmStrip

Move items within the FilmStrip with the Stitch order buttons (Stitch Later , Stitch Earlier , Stitch Last  and Stitch First ) , or by dragging.

- Use Reveal Groups  to view the items within a Group on the FilmStrip, and to move items within and outside Groups.
- Use Command-click to select multiple designs, and Shift-click to select a sequence of designs.
- Command-click on the top row of a Group will select all items within that Group.









Control Panel

Use the Control Panel to edit embroidery designs, repeat designs with Encore, add lettering, add SuperDesigns, add appliqué and decorations to the design, and add a frame or a border to the design.

To Open the Control Panel

- Click the Control Panel button  in the toolbar.
- Choose View > Show Control Panel ().

There are 9 windows in the Control Panel:

	Design	Change colors in embroideries, edit the notes and settings, rotate and resize, use Endless and Split Project. See “Design Window” on page 77.
	Create	Use one of the assistants to create a design, insert a digitized design with mySewnet™ Digitizing, or open a cross stitch design with mySewnet™ Cross Stitcher. See “Assistants” on page 2.
	Encore	Repeat embroideries. See “Encore” on page 103.
	Letter	Add lettering using single or multicolor fonts and fonts of special characters. See “Creating Lettering” on page 355.
	SuperDesign	Add SuperDesigns and adjust their size and appearance. See “Creating SuperDesigns” on page 438.
	Frame	Surround a design or letters with one of over 500 decorative frames and flourishes, add a border or a motif underline. See “Creating Frames, Borders and Underlines” on page 445.
	Appliqué	Create, view and adjust appliqué pieces. See “Creating Appliqué Areas” on page 184.
	Embellish	Decorate your chosen background and embroidery with ribbon, beads, sequins, hotfix crystals or nailheads. See “Creating Embellishments” on page 156.
	Modify	Edit stitches and blocks of stitches, and add color change, stop and trim commands. See “Modifying Stitches and Blocks” on page 125.

Menu Bar

The mySewnet™ Embroidery menu bar is visible if mySewnet™ Embroidery is the active window. Each open embroidery or group of embroideries also has its own document window showing its name.

There are seven menus in addition to the Apple (🍏) menu and the application menu: File, Edit, View, Design, Assistants, Window and Help.

- To access the menu options, use the mouse to pull them down from the menu bar.

Insert Embroideries

Use the Insert dialog to select embroidery designs to customize.

Note: Use Insert to customize an embroidery as part of a new project, and use Open to change the original embroidery. See “Open” on page 26.

To Insert an Embroidery

- 1 Choose File > Insert (or ⌘I).
Alternatively, click Actions  on the toolbar and choose Insert.
- 2 Browse to the desired folder in the Open dialog.
- 3 Switch to Icon View to see thumbnail pictures of the designs in the folder.

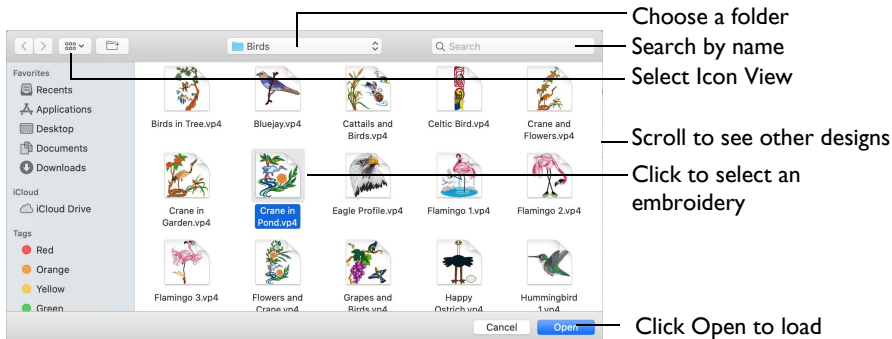

- 4 Scroll to view the other designs in the folder.
- 5 Click an embroidery to highlight it.
- 6 Click the Open button to load the embroidery.
The embroidery is placed in the current window.

Work Area

The work area is the area where embroideries are loaded. The work area includes the area surrounding the selected hoop. It is where you make changes to an embroidery. The stitch area is the available area inside the selected hoop.

Stitches are drawn in the appropriate colors. The embroideries are shown in either 3D or 2D. The background color and texture can be changed using mySewnet™ Configure. You can also load or create a background garment, fabric or quilt block.

In Standard 3D view **3D** the real hoop is shown, with blue corners showing the stitch area within the hoop. The background is shown.

In Realistic 3D view **3D** the embroidery and background are shown without selection boxes, grid or hoop.

In 2D view **2D**, the hoop size is shown by a blue outline with bold corners. Stitches are drawn in plain colors only, and stitches using multicolor threads are drawn using only the first color in the thread definition. The background does not use texture in 2D view.

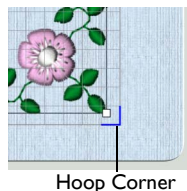

Background Grid

The work area has a grid. Zooming in or out makes the grid squares look bigger or smaller.

Select the Grid and its Size

- To turn the Grid on or off, choose View > Grid (or ⌘).
- To change the size of the grid squares, choose mySewnet™ Embroidery > Preferences (or ⌘,) and set the size.

Hoop

By default, the hoop is shown at a size so that the hoop fills the window, as if you had clicked **Zoom To Fit** .

To Select a Hoop

- Click **Hoop**  in the toolbar, or choose **Edit > Hoop** to open the Hoop dialog. See “Hoop Selection” on page 22.

Note: If a selection box has round handles on its corners, part of it is outside the hoop. Move it into the hoop, or change the hoop size.

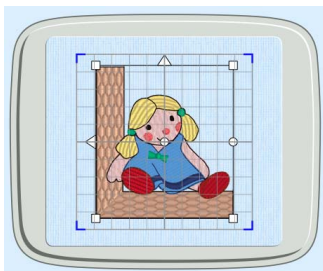



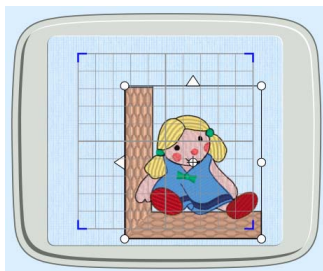

Square handles: inside the hoop



Round handles: outside the hoop

Design Information

The stitch count , dimensions (height  and width ) and number of colors  for the selected embroidery are shown in the Information area of the Design window.

Color Select

The Color Select area of the Design Window shows the colors used in the selected embroidery. See “Color Select” on page 78.

Note: Color Select is blank if no embroidery is selected.

Zooming In or Out

You can enlarge (zoom in) or reduce (zoom out) your view of the work area.

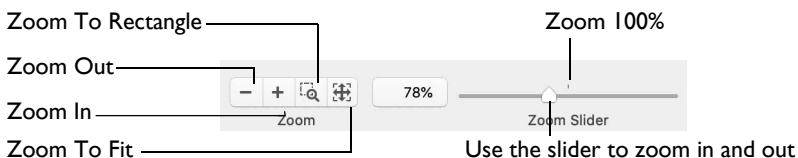

Zoom To Fit shows the hoop so that it fills the window. This is the default size. Click the center marker on the zoom slider to see the embroidery at 100% or real size. See “Zooming In or Out” on page 51.

Using Text and Number Boxes

To view changes made in a text or number box, click in another text/number box, or press the Return key.

Keyboard Shortcuts and Shortcut Menus

You can use the keyboard to perform many of the mySewnet™ Embroidery menu tasks and commands. To see a full list of keyboard shortcuts, open mySewnet™ Embroidery and choose Help > Keyboard Shortcuts. See “Keyboard Shortcuts” on page 558.

Many commands are available from shortcut menus accessed from the design you are creating.

To Open a Shortcut Menu

- Press the Control key while you click on a design.
- Right-click on the mouse or trackpad.

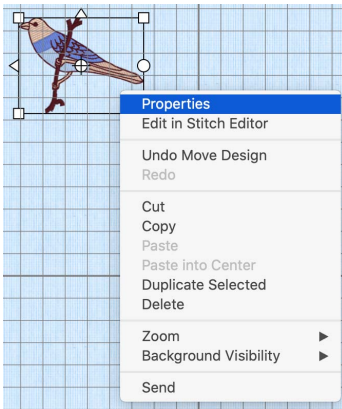

Keyboard Shortcuts

Shortcut key codes

↵	Return key
⌘	Command key (cmd)
⇧	Shift key
⌫	Delete - full sized keyboard only
⌘	Control key (ctrl)
⌥	Option key (alt)
⇧	Tab key
←	Left arrow
→	Right arrow
fn	Function key
⌫	Delete back key (backspace)

Note: On Mac portable keyboards use Function–Delete or Function–Backspace (fn ⌫) to delete an object.

Actions Menu

You can use the Actions menu  to get quick access to many functions.

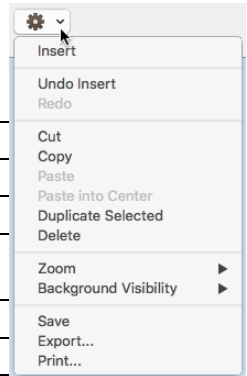

Actions menu commands:

Insert	Open an embroidery in the current window.
Undo	Undo the last action.
Redo	Redo the last Undo.
Cut	Remove the embroidery from the work area and place it on the Clipboard.
Copy	Make a copy of the selected embroidery(ies).
Paste	Paste the embroidery(ies) on the Clipboard.
Paste into Center	Paste the embroidery(ies) on the Clipboard into the center of the work area.
Duplicate Selected	Make a copy of the selected embroidery and paste it on the work area.
Delete	Delete one or more selected embroideries, pieces of lettering or SuperDesigns.
Zoom	Select your desired magnification.
Background Visibility	Set visibility for the active background to a range of levels.
Save	Save the embroidery project in the current window in .vp4 format.
Export	Export the embroidery project in the current window in any embroidery format.
Print	Print a worksheet for the embroidery project.

Additional options are available, depending on what is selected; for example, Properties, stitch types, and so on.

To open the Actions Menu

- Click Actions  on the toolbar. The Actions pop-up menu opens.

mySewnet™ Menu

Use the mySewnet™ menu  to Manage your mySewnet™ account and your mySewnet™ enabled embroidery machine via the mySewnet™ cloud.

To open the mySewnet™ Menu



















- Click mySewnet™  on the toolbar. The mySewnet™ pop-up menu opens.

mySewnet™ Embroidery Terms and Conventions

On-screen pointers





The mouse pointer is most commonly shown as an arrow  on the screen.

The following pointers are also used:

	I-beam	Used when entering text, e.g. in the Notes dialog.
	Move	A four-headed arrow is used when the pointer is over the selection box for one or more embroideries, or when Move Background  is selected.
	Move crop area	A hand is used when moving the crop area in the Rotate and Crop Picture page of some assistants.
	Zoom To Rectangle	Used to drag an area to zoom in to.
	Adjust/Resize	A diagonal double-headed arrow is used when the pointer is over the square corner handle  for a selection box, lettering, a SuperDesign, or a frame. It is also used when moving a crop line in the Rotate and Crop Picture page of some assistants.
	Rotate	Used when the pointer is over the Rotate handle on a selection box.
	Circle Size	Used when the pointer is over the square green adjustment handle for circular lettering types.
	Horizontal	A horizontal double-headed arrow is used when the pointer is over the flip horizontal handle  on a selection box.
	Vertical	A vertical double-headed arrow is used when the pointer is over the flip vertical handle  on a selection box.
	Box Select	The Box Select pointer appears when Box Select is chosen. It also appears when ExpressDesign into Rectangle or PhotoStitch into Rectangle is chosen in the assistants.
	Freehand Select	The Freehand Select pointer appears when Freehand Select is chosen.
	Point Select	The Point Select pointer appears when Point Select is chosen.
	Pick Color	The Pick Colors pointer appears when picking colors from a picture for thread colors in the Choose Thread Colors page of the ExpressDesign or PhotoStitch Assistants.
	Measure	The Measure pointer appears when the Get Length function is selected.
	Insert Stop	The Insert Stop pointer appears when inserting a Stop command.







Dialog Controls

The following control symbols are used in many dialogs.

	Proportional
	Non-proportional
	Rotational Slider
	Flip Vertically
	Flip Horizontally

Information Symbols

The following information symbols are used.

	Height
	Width
	Number of Stitches
	Number of Colors
	Rotate
	Height (percentage)
	Width (percentage)

Multi-Touch Gestures

Multi-Touch gestures are used when viewing and moving embroideries in mySewnet™ Embroidery.

- To set the use of Multi-Touch Gestures, scroll bars and secondary click options, choose Apple Menu > System Preferences, then select Mouse or Trackpad to set the preferences for your hardware.

Autoscroll

You can autoscroll on a portable Mac's Multi-Touch trackpad, a Magic Trackpad or a Magic Mouse.

When you drag within a document, the autoscroll feature moves the pointer automatically, changing the view of the work area. This is useful when zoomed in. Use autoscroll while moving or resizing a selected embroidery.

- On a portable Mac's Multi-Touch trackpad, or a Magic Trackpad, use a two finger swipe.
- On a Magic Mouse, use a one finger swipe.

Note: The scroll bars may only appear when you are scrolling. To always show the scroll bars, choose Apple Menu > System Preferences > General > Show scroll bars: Always.

Pinch to zoom

You can use Pinch to zoom on a trackpad to zoom in and out.

- On a portable Mac's Multi-Touch trackpad, or a Magic Trackpad, pinch two fingers to zoom in, and spread two fingers to zoom out.

Note: You must set the trackpad scroll and zoom options to Zoom in or out. See "Customizing Multi-Touch Gestures on a Trackpad" on page 19.

Secondary click for Control-click

You can set a secondary click for Control-click when using a trackpad or the Magic Mouse. A short video demonstrates how to use these gestures.

- Choose Apple Menu > System Preferences, then select Mouse. In Point & Click, select Secondary Click: Click on right side.
- Choose Apple Menu > System Preferences, then select Trackpad. In Point & Click, select Secondary Click, then choose a click method in the pop-up menu, for example, Click in bottom right corner.

mySewnet™ Embroidery and mySewnet™ Stitch Editor Only

Pinch to resize or scale

You can use Pinch to resize or scale the selected embroidery on a trackpad.

- On a portable Mac's Multi-Touch trackpad, or a Magic Trackpad, pinch two fingers to reduce the size, and spread two fingers to increase the size.

Note: You must set the trackpad scroll and zoom options to Zoom in or out. See "Customizing Multi-Touch Gestures on a Trackpad" on page 19.

Rotate

Twist your thumb and forefinger to rotate the selected embroidery, block of stitches, lettering or SuperDesign when using a trackpad.

- On a portable Mac's Multi-Touch trackpad, or a Magic Trackpad, twist your thumb and forefinger to rotate the selected embroidery.

Note: You must set the Trackpad scroll and zoom options to Rotate. See "Customizing Multi-Touch Gestures on a Trackpad" on page 19.

Customizing Multi-Touch Gestures on a Trackpad

The System Preferences options below show short videos of how the gestures should be used.

- 1 Choose Apple Menu > System Preferences.
- 2 Select Trackpad.
- 3 To use Pinch to zoom, select Scroll & Zoom, and then select the "Zoom in or out" checkbox.

When Zoom in or out is highlighted, a video demonstrates how to use Pinch to zoom.

- 4 To use Rotate, select Scroll & Zoom, and then select the Rotate checkbox. A video demonstrates how to use Rotate.

File Formats

Embroidery Files

mySewnet™ Embroidery can load any of the following embroidery file formats: Bernina (.art version 1, 2, 3), Brother/Baby Lock/Bernina PEC (.pec), Brother/Baby Lock/Bernina PES (.pes version 2 - 11), Compucon/Singer PSW (.xxx), Husqvarna Viking / Pfaff (.vp4, .vp3, .vip), Husqvarna (.hus, .shv), Janome (.jef, .sew), Melco (.exp), Pfaff (.pcs), Tajima (.dst) and Toyota (.10*).

Note: To load Melco .exp format, you must use Insert, not Open.

mySewnet™ Embroidery saves embroidery files in Husqvarna Viking / Pfaff (.vp4) format.

Note: Embroideries may only be saved in .vp4 format as this will preserve the separate parts of multipart designs. It also preserves thread color information and notes.

mySewnet™ Embroidery exports embroidery files in any of the following embroidery file formats: Husqvarna Viking / Pfaff (.vp4, .vp3, .vip), Brother/Baby Lock/Bernina PEC (.pec), Brother/Baby Lock/Bernina PES (.pes version 2 - 11), Compucon/Singer PSW (.xxx), Husqvarna (.hus, .shv), Janome (.jef, .sew), Melco (.exp), Pfaff (.pcs), Tajima (.dst) and Toyota (.10*).

Image Files

The following popular image file formats may be loaded as backgrounds for your projects or to create embroideries: Bitmap (.bmp), Encapsulated PostScript (.epi, .eps), Graphics Interchange Format (.gif), JPEG-JFIF Compliant (.jpg, .jiff, .jpeg), JPEG 2000 (.jp2, .jpf), JPEG Multi-Picture Object (.mpo), Photoshop (.psd), Portable Document Format (.pdf), Portable Network Graphics (.png), Postscript (.ps), Tagged Image File Format uncompressed (.tiff, .tif), Camera RAW (.raw & many others), High Dynamic Range (.exr, .hdr), High Efficiency Image Format (.heic).

These additional formats can also be loaded: Apple Icon (.icns), Fax (.fax & many others), Linux Icon (.xbm), Macintosh Picture (.pct, .pic, .pict), MacPaint (.mac, .pnt, .pntg), Microsoft Icon (.cur, .ico), Silicon Graphics (.rgb, .sgi) and Truevision TGA (.targa, .tga).

Design Files

mySewnet™ Embroidery can load, but not edit, .edo design outline files from mySewnet™ Digitizing.

Note: Use Edit Design to adjust these designs in mySewnet™ Digitizing.

Backgrounds

In addition to the basic Backgrounds installed with the software, further Backgrounds can be downloaded and installed from the Downloads page: download.mysewnet.com.

The following background file types and formats can be loaded and saved: garment, fabric and quilt block (.ebkg).

Note: Fabric backgrounds are stored as .ebkg files. All backgrounds that you add are stored as .ebkg files.

Hoop Selection

Use Hoop Selection  to select a hoop size to use in mySewnet™ Embroidery. You can use the size of your embroidery, the hoop you wish to use for stitching out, or enter any other desired size.

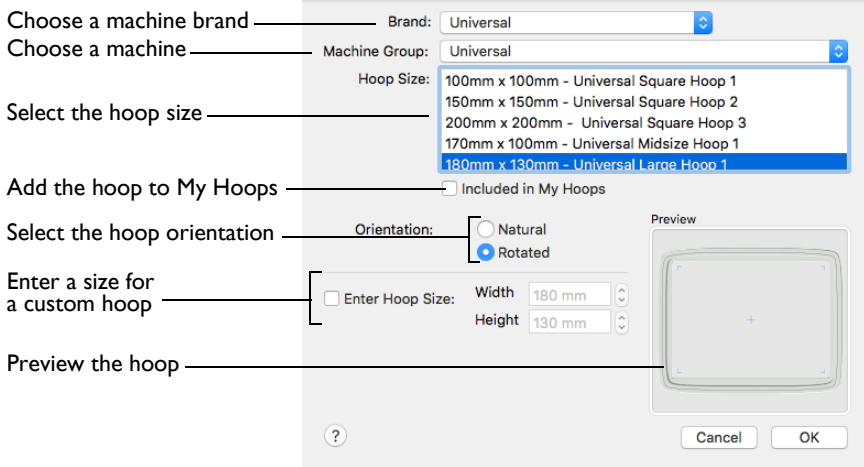

To open the Hoop Selection dialog

- Click Hoop  in the toolbar, or choose Edit > Hoop to open the Hoop dialog.

Brand

The pop-up Brand menu shows all the machine brands, and Universal hoops.

Hoop Group

The pop-up Machine Group menu shows all the machine Hoop Groups.

Note: All available hoops for the selected machine are listed.

Hoop Size

The Hoop Size list shows the hoops in the chosen Hoop Group. A picture of the selected hoop is shown in the Preview.

Included in My Hoops

The Included in My Hoops checkbox is used to add hoops to the My Hoops list. Use this to create a list of your favorite hoops.

Note: The selected hoops are displayed in the My Hoops group in the order that they were chosen.

Orientation

Select Natural or Rotated orientation according to the shape of the embroidery that is to fit in the hoop.

Enter Size

Use Enter Size to enter a hoop size that is not listed in any of the Hoop Groups. You can enter any size from 10mm to 2000mm in the width and height boxes.

Note: If you position the arrow pointer over the box without clicking, the alternative units and range will be shown.

Choose a Hoop

- 1 Click Hoop  in the toolbar.
- 2 Choose a Brand from the pop-up menu.
Select a machine brand, or use Universal.
- 3 Choose a Machine Group from the pop-up menu.
Select the name of a machine, or a group of similar machines.
- 4 Select the hoop orientation.
The hoop is shown in the preview.
- 5 Click OK to use the hoop in the work area.

Enter a Size for a Custom Hoop

- 1 Click Hoop  in the toolbar.
- 2 Select the checkbox labelled "Enter Hoop Size".
- 3 Enter the dimensions in the height and width number boxes.
Your custom hoop is shown in the preview.
- 4 Click OK to use the hoop in the work area.

Learn how to open embroideries and new windows, how to save and export embroideries, how to combine your embroideries, and how to add notes to them. Cut, copy, paste and duplicate your embroideries, and undo and redo your changes.

New

Use New to open a new mySewnet™ Embroidery window at the Welcome Screen so that you can adjust pasted embroideries or place lettering, motifs, SuperDesigns or frames.

Note: To load an embroidery into an existing mySewnet™ Embroidery window, use Insert.

To open a new window

- Choose File > New.
- Press ⌘N

Opening Embroideries

Open embroideries into an existing or new window.

- Use Insert to load individual files by icon, name or number into the current window.
- Use Open to load individual files by icon, name or number into a new window.
- Use Open Recent to reopen recently edited files into a new window.
- Use Paste to insert a file from the Clipboard into the current window.
- Double-click on an embroidery file in the Finder. The embroidery will open in a new window.

Use Insert to load Melco .exp format.



Note: You can use Insert to open the same embroidery as many times as desired. Each time it is opened, a new copy is added to the work area.

Insert

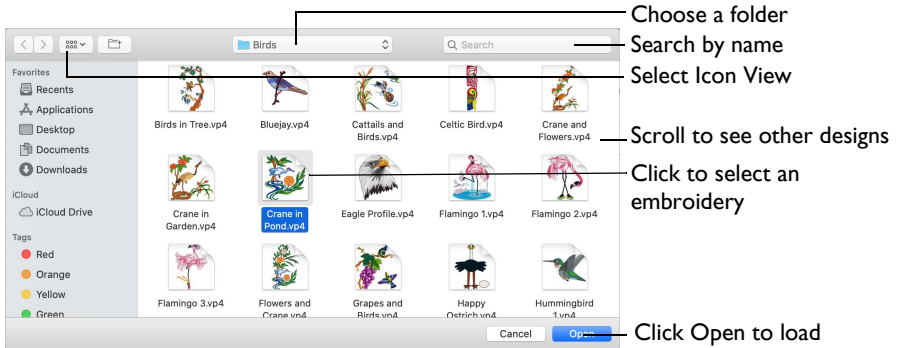

Use Insert to select embroidery designs to customize. mySewnet™ Embroidery displays the Insert dialog so you can load a saved embroidery into an existing window, or start a completely new project.



To insert an embroidery

- Click Actions  on the toolbar and choose Insert.
- Choose File > Insert.
- Press 

Insert an Embroidery

- 1 Click Actions  on the toolbar and choose Insert. Alternatively, choose File > Insert or .
- 2 Browse to the desired folder in the Open dialog.
- 3 Switch to Icon View to see thumbnail pictures of the designs in the folder.
- 4 Scroll to view the other designs in the folder.
- 5 Click an embroidery to highlight it.
- 6 Click the Open button to load the embroidery.
The embroidery is placed in the current window.

Note: Alignment stitches are removed.

File Formats

Use Insert to load the following file formats: Husqvarna Viking / Pfaff (.vp4, .vp3, .vip), Bernina (.art version 1, 2, 3), Brother/Baby Lock/Bernina PEC (.pec), Brother/Baby Lock/Bernina PES (.pes version 2 - 11), Compucon/Singer PSW (.xxx), Husqvarna (.hus and .shv), Janome (.jef and .sew), Melco (.exp), Pfaff (.pcs), Tajima (.dst), and Toyota (.10*).

Only Husqvarna Viking / Pfaff (.vp4 and .vp3) embroidery files contain full thread color information that is shown in the original thread colors. Other files that hold some color information, such as .hus, .shv, .pcs, .pes, .sew and .xxx, are shown in the nearest match to the colors in which they were created. The shades are converted to the Import Thread Range, as selected in mySewnet™ Configure. For

files that do not store colors, such as .dst, .exp and .10*, the embroidery is shown in a default color sequence, using thread colors from the Import Thread Range.

Open

Use Open to load a saved embroidery into a new window. All formats can be opened except Melco (.exp). mySewnet™ Embroidery displays the Open dialog so you can select an embroidery to open.

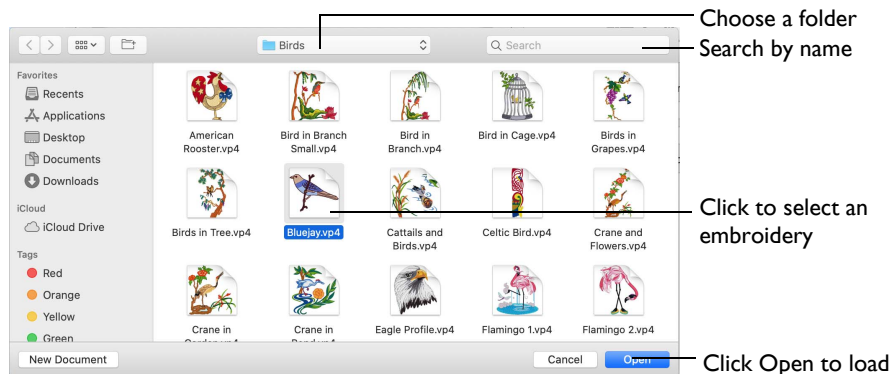

The new window uses the filename as its title.

Note: To avoid accidentally overwriting your original embroidery, it is recommended to use Duplicate or Save As and work from a copy when using Open.

To use Open

- Choose File > Open.
- Press ⌘O
- Double-click on an embroidery in Finder.

Open an Embroidery

- 1 Choose File > Open (or press ⌘O).
 - 2 Browse to the desired folder in the Open dialog.
 - 3 Click an embroidery to highlight it.
 - 4 Click the Open button to load the embroidery.
- The embroidery is placed in a new window with its name in the window title.

Note: Alignment stitches are retained.

Open Recent

Use Open Recent to open a menu of previously used embroideries.

Note: To avoid accidentally overwriting your original embroidery, it is recommended to use Duplicate and work from a copy when using Open Recent.

To open a recently used embroidery

- Choose File > Open Recent, and choose an embroidery from the menu.



Note: Click File > Open Recent > Clear Menu to remove the list of recent embroideries.

Edit Design



Move between mySewnet™ Embroidery Software apps using Edit Design  and adjust the selected part of your project in another app. Embroideries are opened in mySewnet™ Stitch Editor, and .edo design files are opened in mySewnet™ Digitizing.

Note: You can also open other apps from the Welcome page or Create window.

To Edit a Selected Design in Another App

- Select the design, and then in the Design window  of the Control Panel  click Edit Design . A linking dialog is displayed, and the appropriate app opens.
- Select the design, and then Control-click and select "Edit in..." in the context menu. A linking dialog is displayed, and the appropriate app opens.

Adjusting a Design in Another App

- 1 Select the subdesign to be changed, and then in the Design window  of the Control Panel  click Edit Design .





First the linking dialog opens, followed by the app to edit the design. For example, mySewnet™ Digitizing is opened for .edo designs.

- 2 Edit the embroidery or design as desired.
- 3 If you will want to use this subdesign again separately from your original project, save the design within the linked to app.
- 4 Close the app, and your edited subdesign appears in the mySewnet™ Embroidery work area.

Note: You can also close by clicking Finish in the linking dialog.

Notes and Settings





Use the Notes  and Settings  to add a description or category to your embroidery. The Notes and Settings box is found on the Design window.

Store up to 2000 characters of notes about an embroidery. This information is shown in the Notes and Settings box on the Design window.

Note: To keep the Notes information, save your embroideries as file type Husqvarna Viking / Pfaff (.vp4, .vp3 or .vip).

When embroideries are merged with Combine or Export, all the notes are also merged and shown in the Notes box. You may wish to edit the notes and remove duplicate text when you have combined several copies of the same embroidery.

To Edit the Notes or Settings

- In the Design window  of the Control Panel , select Notes  or Settings , then click Edit  to open the Notes or Settings dialog and add some text.

Note: Use Option–Return or Control–Return to start a new line of text.

Notes

The Notes dialog allows free text and keywords to be added to the Notes for the selected embroidery.



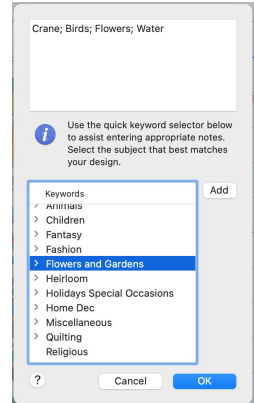

Up to 2000 characters can be entered in the Notes.

Add Keywords for the embroidery from the list.

When embroideries in .vp4, .vp3, .vip, .hus, .pcs and .pes formats are loaded in mySewnet™ Embroidery, any notes are automatically placed in the Notes box.



Enter Notes for an Embroidery

- 1 In the work area, select the embroidery for which you want to add some notes. The embroidery is highlighted.
- 2 Open the Design window  in the Control Panel .
- 3 Click Notes .
- 4 Click Edit . The Notes dialog appears.
- 5 In the Notes text box add some text to the Notes.
Use Option–Return or Control–Return to start a new line of text.
- 6 To add keywords, select the Keyword from the Category heading or subcategory in the scrolling list. Then click Add to add them to the Notes.
- 7 Click OK to save your amended Notes. The notes can be seen in the Design window.

Settings

Use the Settings to store information on the settings used in your embroidery.



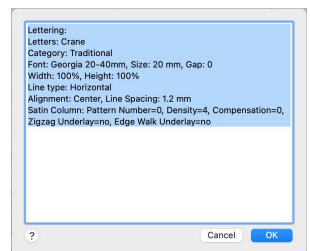

Up to 2000 characters can be entered in the Settings.

Information about lettering, monograms, motifs, SuperDesigns, frames and borders is automatically placed in the Settings.



Enter Settings Information

- 1 Select the embroidery for which you want to amend the settings. The embroidery is highlighted.

- 2 Open the Design window  in the Control Panel .
- 3 Click Settings .
- 4 Click Edit . The Settings dialog appears.
- 5 In the Settings text box make your desired changes to the Settings.
Use Option-Return or Control-Return to start a new line of text.
- 6 Click OK to save your amended Settings. The settings information can be seen in the Settings area in the Design window.

Combine

Use the Combine functions, if desired, to merge the embroideries in your project into a single embroidery. The Notes and Settings from these embroideries are also merged. Embroideries are combined when exported for stitchout if the default settings are retained, so it is not required to use Combine before saving.

Note: Use Group to work with several designs as a single unit. See “Group” on page 91.

The embroideries are combined in the exact order that they were loaded into, or created in mySewnet™ Embroidery. This will be the stitchout order. To change this order, use the FilmStrip or the Layout Order commands. See “FilmStrip” on page 9 and “Layout Order” on page 102.

After embroideries are combined, the Design window shows the colors, and information on the stitch count, height and width and number of colors in the merged embroidery. The notes and settings from all the embroideries are combined in the Notes and Settings boxes. Any overlapping stitches are removed if the option is selected in Preferences.

Combine All

Use Combine All to merge all the embroideries in the current window into a single embroidery.

To use Combine All

- Choose Design > Combine All.
- Press 

Combine all Embroideries in the Current Window

- 1 Click New to open a new screen, then load the desired embroideries.
- 2 Create additional lettering, SuperDesigns or frames if required, and move, modify and edit each embroidery as desired.
- 3 Choose Design > Combine All (or press ). The embroideries are merged, with one outline box surrounding all of them.

Note: The Color Select area of the Design window will now show the color blocks for the new combined embroidery.

- 4 The Notes box contains the notes from all the embroideries that have been combined. Edit the Notes as desired. See “Notes” on page 28.
- 5 Save the new embroidery.

Combine Selected

Use Combine Selected to merge the selected embroideries into a single embroidery.

To use Combine Selected

- Choose Design > Combine Selected.
- Press ⌘U

Combine Selected Embroideries

- 1 Load the desired embroideries onto the current screen. There is no need to delete any that are already there.
- 2 Use Multiple Select to select the desired embroideries. See “Multiple Select Features” on page 88.
- 3 Choose Design > Combine Selected (or press ⌘U). The embroideries are merged, with one outline box surrounding all of them.
Note: The Color Select area of the Design window will now show the color blocks for the new combined embroidery.
- 4 The Notes box contains the notes from all the embroideries that have been combined. Edit the Notes as desired.
- 5 Save the new embroidery.

Fix as Stitches

Use Fix as Stitches to fix the selected subdesign or subdesigns as embroidery.

You may wish to fix designs to mirror lettering, or a selection or group; to resize or scale without constant properties; or to rotate the Appliqué Fabric in a SuperDesign.

Note: Designs such as lettering, SuperDesigns, frames and Monograms can be resized with constant stitch density, and the stitch types adjusted, until they are fixed as embroidery. They are also fixed as embroidery when you adjust them in the Modify window in mySewnet™ Embroidery.

To use Fix as Stitches

- Choose Design > Fix as Stitches.
- Control-click and choose Fix as Stitches.
- Press ⌘U

Save Embroideries

There are five methods of saving embroideries:

Save

This saves the contents of the open window as a multipart embroidery in .vp4 format, with the name you give it, in the Save dialog.

When saving on subsequent occasions, the contents of the open window is saved under its current name as a multipart embroidery in .vp4 format. A backup is made of previous versions.

Duplicate

This makes a multipart copy of the open window using that document's name, with the word "copy" at the end. Use Save to save this copy under a different name, or in another folder, in the Save dialog.

Save As

Use Save As to save the contents of the current window as a multipart embroidery in .vp4 format under a new name.

Export

This saves the contents of the open window in the desired format according to the chosen options to optimize for sewing.

Save On Close

If you make changes to an unsaved embroidery, then try to close the embroidery window before saving the changes, a message appears, asking if you want to save the embroidery.

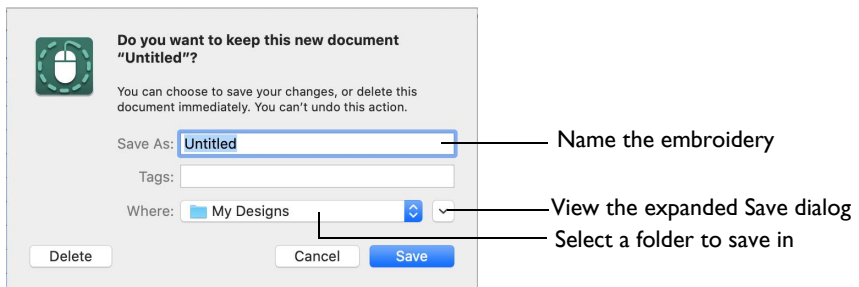

Note: If you have already saved the embroidery, this message will not appear, as an autosave is made as the window closes.

You are asked about the unsaved embroidery. Choose between:

- Save** Save the changes to the embroidery. Use the name and folder selected in the dialog.
- Don't Save** Do not save the embroidery and continue. The embroidery is discarded without being saved.
- Cancel** Do not save the embroidery, but keep the embroidery window open.

Note: If you make a mistake when changing an embroidery, use Revert To to recover the previous version. See "Revert To" on page 48. After saving you may rename an embroidery. See "Rename" on page 48.

Save

When you save an embroidery file for the first time, mySewnet™ Embroidery displays the Save dialog so you can name your multipart .vp4 embroidery file.

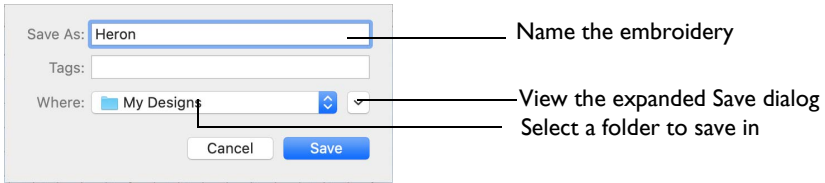

Note: Depending on previous choices when saving files, the compact or expanded save dialog is shown.

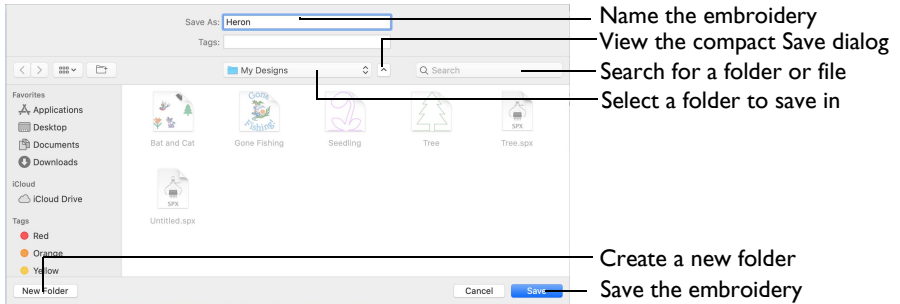

The embroidery is saved as a multipart embroidery in .vp4 format. This keeps the separate sections, and preserves thread color information and notes.

Note: To use other embroidery formats, choose Export. See “Export” on page 33.

When you save the embroidery subsequently, the existing name is used. A backup is made of previous versions.

Note: Use Revert To to go back to a previous version. See “Revert To” on page 48.

To use Save

- Click Actions  on the toolbar and choose Save.
- Choose File > Save.
- Press **⌘S**

Save an Embroidery

- 1 Create an embroidery project using existing designs, text, frames and SuperDesigns.
- 2 Click Actions  on the toolbar and choose Save to save the design in the Save dialog. Alternatively, choose File > Save (or press **⌘S**).
- 3 In the Save As text box, enter a name for your embroidery.
- 4 Browse to the desired folder, or create a new folder.
- 5 Click the Save button to save the embroidery.

Duplicate

Use Duplicate to make a copy of the multipart embroidery in the current window using that embroidery's name. The new window will use the original name with the word "copy" at the end. You could use Duplicate to remove part of a multipart embroidery and save the changed embroidery under a new name.

Then use Save to save the copied embroidery under a different name and/or folder.

Note: When an embroidery is Duplicated the version history is not kept.

To use Duplicate

- Choose File > Duplicate.
- Press $\hat{\uparrow}$ ⌘S

Duplicate an Embroidery

- 1 Create an embroidery project using existing designs, text, frames and SuperDesigns.
- 2 Choose File > Save (or press ⌘S) to Save the embroidery. See "Save" on page 32.
- 3 Choose File > Duplicate (or press $\hat{\uparrow}$ ⌘S).

A new window is opened containing a copy of the saved embroidery. The new window uses the same name as the original, but with the word "copy" at the end.

- 4 Choose File > Save (or press ⌘S).
- 5 Save the duplicated embroidery in the Save dialog under the desired name and folder.

Save As

Use Save As to save the contents of the current window as a multipart embroidery in .vp4 format under a new name.

To use Save As

- Choose File > $\hat{\downarrow}$ > Duplicate.
- Press $\hat{\downarrow}$ $\hat{\uparrow}$ ⌘S

Export

Save the project in the current window in the desired format according to the chosen options to optimize for sewing. The embroidery must fit in the currently selected hoop. Use the Design Player to see how the embroidery will be exported according to the current Optimize for Sewing Options.

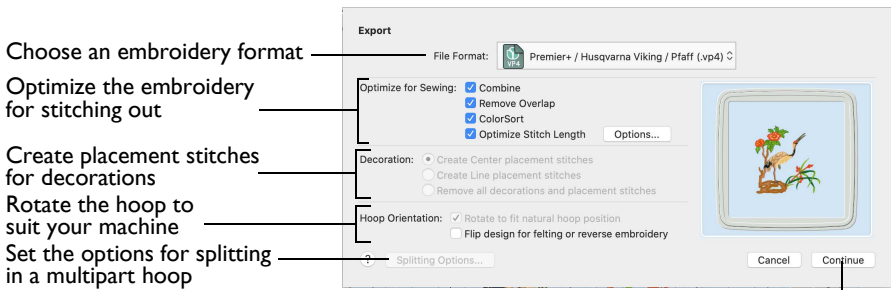

Go to the "Save" or "Saving as" dialog

The preferred file format for exporting embroideries is Husqvarna Viking / Pfaff .vp4, as this will preserve the separate parts of multipart designs. It also preserves thread color information and notes.

You can also export embroideries as Husqvarna Viking /Pfaff (.vp4, .vp3, .vip), Brother/Baby Lock/Bernina PEC (.pec), Brother/Baby Lock/Bernina PES (.pes), Compucon/Singer PSW (.xxx), Husqvarna (.hus, .shv), Janome (.jef and .sew), Melco Expanded (.exp), Pfaff (.pcs), Tajima (.dst) or Toyota (.10o).

Note: The initial name is the current file name with "Exported" added. The text "Exported" may be changed in mySewnet™ Configure.

To use Export

- Click Actions on the toolbar and choose Export.
- Choose File > Export.
- Press $\backslash \&S$

Optimize for Sewing Options

All of these options are initially selected when saving as a .vp4 file, or in any other format.

Note: You can customize the Optimize for Sewing Options in mySewnet™ Configure.

Combine: Merge the embroideries into a single embroidery during Export. See "Combine" on page 29.

Note: Combine is not enabled if there is only one design, and for embroidery formats that are automatically combined.

Remove Overlap: Prevent areas of stitches building up where embroideries overlap.

Remove Overlap is not available when Combine is not enabled.

Note: Only deselect this option if, for example, your embroideries are low density and you wish to have a blend effect where they overlap. Also, some multipart embroideries are created with areas that are designed to overlap each other near

the mid-section of a turnable hoop. When viewing these designs in mySewnet™ Embroidery, deselect Remove Overlap before exporting. Deselect Remove Overlap in mySewnet™ Configure, Export, before sending them to the embroidery machine.

ColorSort: Reduce the number of thread colors during Export. See “ColorSort” on page 86.

Optimize Stitch Length: Automatically remove small and insignificant stitches. See “Optimize Stitch Length” on page 38.

Note: Cutwork Needle lines in the Inspira Cutwork Needle "thread range" are unaffected by Optimize Stitch Length.

Decoration

Create Center or Line placement stitches for Decorations added in mySewnet™ Embroidery, or remove all decorations and their associated placement stitches.

Center or Line placement stitches are created automatically for decorations according to the options set in mySewnet™ Configure, which may be altered when you export the embroidery. Alternatively, create crystal transfer templates for automated cutters with Export Decoration Template.

Center placement stitches are recommended when most decorations are individual and symmetrical. Line placement stitches are recommended when most decorations are individual and asymmetrical (such as bugle beads) or lines of closely spaced beads or sequins.

Create Center placement stitches: Create a small cross shape in stitches to show where the decoration is to be placed.

Create Line placement stitches: Create a single stitch that runs along the length of the decoration.

Remove all decorations and placement stitches: Remove all decorations and placement stitches from the exported version. This may be desired to create an embroidery with a complementary crystal transfer template (made using the Export Decoration Template dialog). See “Export Decoration Template” on page 41.

Hoop Orientation

Set the hoop orientation.

Rotate to fit natural hoop position: Rotate the embroidery if needed to fit with the default hoop orientation for the machine. This option is only available if the hoop on the main screen is in the rotated orientation. It is useful if you prefer to create a "landscape" shaped project in the rotated orientation.

Flip design for felting or reverse embroidery: Flip the embroidery for being stitched in reverse. If an embroidery contains a Felting Needle color effect this option is selected initially. See “Felting Needle” on page 82.

Splitting options

Click the button to open the splitting options dialog. See “Splitting for Multipart Hoops” on page 36.

Note: Splitting for Multipart Hoops is available if .vp4, .vp3, .pes or .jef is chosen.

Additional Sections

Additional dialog sections are available, depending on the chosen file format.

- If .vp4, .vp3, .pes or .jef is chosen, Splitting for Multipart Hoops is present. See “Splitting for Multipart Hoops” on page 36.
- If .pes is chosen, you can select your machine type, file version, hoop size and rotation.
- If .jef is chosen, you can select your machine type, hoop size and rotation.

Continue

View the Save, or Saving As dialog, depending on the selected file format.

Export an Embroidery

- 1 Create an embroidery project using existing designs, text, frames and SuperDesigns.
- 2 Save the embroidery. See “Save” on page 32.
- 3 Choose File > Export (or press \backslash ⌘S).
- 4 Choose an embroidery format from the pop-up menu.
- 5 Select your optimization options.
- 6 If you are using a multipart hoop, set Intelligent or Straight Line split.
- 7 Click Continue.
- 8 The Save or Saving As dialog appears. Save the embroidery as desired.

Note: When exporting an embroidery, the message “Embroidery is too large or will not fit in hoop.” may appear. This means that some part of your embroidery is not entirely within the hoop, as indicated by round resize handles on the embroidery.

If you have multiple elements that need to be combined, use \mathbb{K} and the arrow keys to step through the embroideries until you find the item with round resize handles. Drag the embroidery so that it is inside the hoop. Alternatively, use the Design > Move Into Hoop feature.

Splitting for Multipart Hoops

Note: This section appears if .vp4, .vp3, .pes or .jef is selected as the file format.



Embroideries for Multipart hoops are split automatically, according to your Export settings. Use an Intelligent or Straight Line Split.

Note: There is no need to ensure embroideries are in one stitch area of the hoop; just place your embroideries in the most pleasing arrangement.

Split Method

You can use one of two split methods:

- **Intelligent Split** automatically calculates a split line that cuts the minimum number of stitches, and minimizes cuts through solid sections of embroidery. Where possible, use Intelligent Split.
- **Straight Line Split** cuts the embroidery straight across the center line of the overlap zone.

Intelligent with Tolerance

Intelligent Split calculates a split line that cuts the minimum number of stitches, and minimizes cuts through solid sections of embroidery. For example, a large embroidery is split at a narrow section, and an embroidery that fits in one stitch area of the hoop is left in one piece even if it is part of a larger design.

Tolerance ensures that the Intelligent Split line stays a short distance from the edges of the overlap. This allows for play in the hoop when going from one hoop area to another, such as when aligning a hoop that has been turned to stitch out the other side of an embroidery.

You can set Tolerance from 0 to 3mm, in steps of 1mm. The initial setting is 1mm.

Use Intelligent Split with Tolerance

- Select the "Intelligent with Tolerance" checkbox, then enter a number in the Tolerance number box, or use the arrows to increase or decrease the Tolerance.

Straight with Compensation

Straight Line Split cuts straight across the center of the overlap zone. Straight Line Split will only split an individual embroidery if, before it is combined with everything else, it does not fit entirely into one stitch area of the hoop.

Note: Lettering is split straight down the middle, as with any other type of embroidery. This may cut through characters rather than gaps and spaces. In such cases, it is recommended to use Intelligent Split instead.

Compensation adds overlapping stitches along the edges where the embroidery is split. This compensates for pull on the fabric.

None	Use None if you can split an embroidery without cutting through any of the design elements. Compensation is initially set to None.
Low	Use Low when cutting through a lightly stitched embroidery or when the split lines go through only a few stitch areas.
High	Use High when the embroidery is dense, when the split lines make long splits through stitch areas, or when stitching onto materials such as knitted or stretchy fabric.

Alignment Stitch for Turnable Hoops

Select this option to add an alignment cross at the end of the first embroidery section when using the HUSQVARNA VIKING® Designer Majestic™, PFAFF® creative Grand Dream™, Universal Multipart hoop or Brother Jumbo Frame. A hoop movement to the alignment cross is added at the beginning of the next section. The next embroidery section can then be correctly aligned, or alignment can be confirmed.

Optimize Stitch Length

Use Optimize Stitch Length to automatically remove small and insignificant stitches.

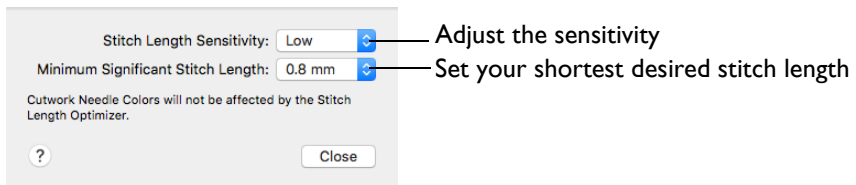

Stitch Length Sensitivity

Adjust the sensitivity of the optimization. Low is set as the default.

- Choose Low, Medium or High from the pop-up menu.

Minimum Significant Stitch Length

Select the shortest stitch length that you consider to be significant. Stitches below this length are removed during the optimization process. The default stitch length is 0.8 mm.

Note: Cutwork Needle lines are unaffected by the Minimum Significant Stitch Length.

- Choose 0.6 mm, 0.8 mm or 1.0 mm from the pop-up menu.

Export Appliqué Pieces

Use Export Appliqué Pieces to save or print appliqué outlines ready for cutting.

Set file formats and measurement units for your cutter

Export an SVG, DXF or FCM file for use in a fabric cutter

Use 2 or 4 cutwork needles

Print as an outline template for cutting out

Print onto printable fabric or an iron-on transfer

Save as a PNG custom layout with fabric images

Flip picture if using a transfer

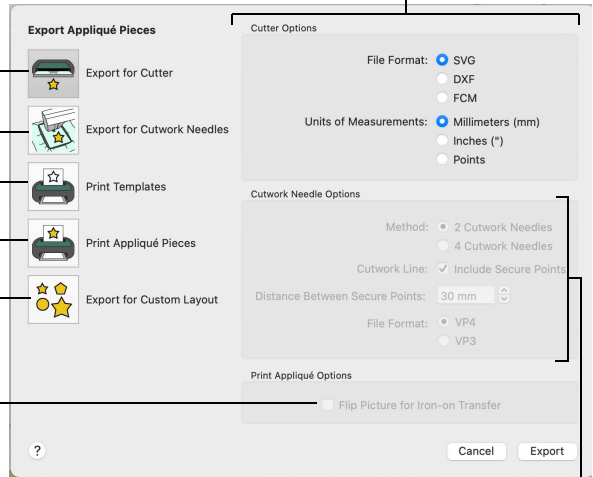

Set cutwork needle type, file format, and secure points for fabric stability

There are five appliqué piece export methods:

- **Export for Cutter:** Save as SVG, DXF or FCM files for use in fabric cutters
- **Export for Cutwork Needles:** Save as VP4 or VP3 stitch files that can be used with INSPIRA™ Cutwork Needles
- **Print Templates:** Print as an outline template to stick or pin to fabric and then cut out
- **Print Appliqué Pictures:** Print directly onto printable fabric or an iron-on transfer; this also prints the image of the appliqué piece
- **Export for Custom Layout:** Save as PNG files with the fabric image placed as the fill for each shape. This is designed for use with fully customized layouts.

Export for Cutter

Export the appliqué piece as an SVG, DXF or FCM image file for use in a fabric cutter.

Set the units of measurement (millimeters or inches), and select a file type. Click Export to save the file.

Note: The maximum size for the Brother ScanNCut FCM format is 12" x 12" (305mm x 305mm).

Recommended file formats for cutters:

Cutter	Software	Export Format
Cricut Explore®	Cricut Design Space 3.1512	SVG (points)
KNK Zing Air®	Make the Cut! 4.6.1 (Zing Plugin 2.1.0)	SVG (points)
Silhouette Cameo®	Silhouette Studio 3.6.57 ss (Use "As Is" import settings)	DXF (millimeters)
Brother ScanNCut® (2)	Direct to USB stick or machine	FCM
Sizzix Eclips2	eCal2 2.203	SVG (points)

Export for Cutwork Needles

Export the appliqué piece for cutting with INSPIRA™ Cutwork Needles. Select 2 or 4 needles, choose whether to use secure points for fabric stability and their length, and use a .vp3 or .vp4 stitch file.

Print Templates

Print the appliqué piece as an outline template to stick or pin to fabric and then cut out.

Select a printer and paper size in the Print dialog. See “Print” on page 517.

Print Appliqué Pictures

Print directly onto printable fabric or an iron-on transfer; this also prints the image of the appliqué piece.

Flip the picture for an iron-on transfer, and select a printer and paper size in the Print dialog. See “Print” on page 517.

Export for Custom Layout

Save as PNG files with the fabric image placed as the fill for each appliqué piece shape. This is designed for use with fully customized layouts, for example if you wish to arrange the shapes in your cutter software or in another graphics package.

Using Export Appliqué Pieces

In the Export appliqué pieces dialog, select the desired method and options, then click the Export or Print button.

To use Export Appliqué Pieces

- Choose File > Export Appliqué Pieces.

Export Decoration Template

Use Export Decoration Template to save a template for all your decorations in a format for your automated cutter. This can be used to create a crystal transfer template (or rhinestone template) for pressing hotfix crystals and nailheads directly onto your work.

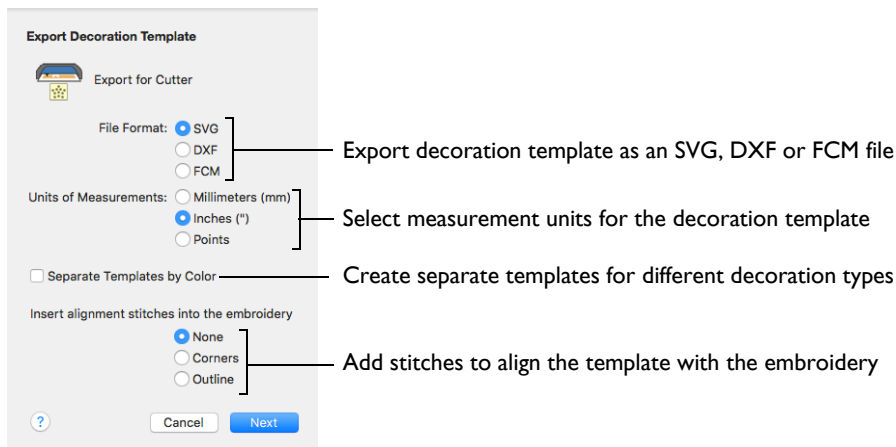

Export for Cutter

Export the decorations as an SVG, DXF or FCM image file to create a crystal transfer template for use in an automated cutter.

Set the units of measurement (millimeters or inches), and select a file type.

Recommended file formats for cutters:

Cutter	Software	Export Format
Cricut Explore®	Cricut Design Space 3.1512	SVG (points)
KNK Zing Air®	Make the Cut! 4.6.1 (Zing Plugin 2.1.0)	SVG (points)
Silhouette Cameo®	Silhouette Studio 3.6.57 ss (Use "As Is" import settings)	DXF (millimeters)
Brother ScanNCut® (2)	Direct to USB stick or machine	FCM
Sizzix Eclips2	eCal2 2.203	SVG (points)

Template Options: Select (check) **Separate Templates by Color** to create a separate template for different decoration types, for example if you wish to use the same size of crystal in two different color ways.

Alignment Stitches: Add alignment stitches for aligning the decoration subdesign with the embroidery. Select from **None** (the default), **Corners** and **Outline**.

To use Export Decoration Template

- Choose File > Export Decoration Template.

Sending Embroideries

Send designs to your mySewnet™ enabled embroidery machine via mySewnet™ from within the mySewnet™ Embroidery Software, or directly from your mySewnet™ account.

Use mySewnet™ Connect to change your mySewnet™ settings.

Send

Use the Send dialog to send the selected embroidery to the mySewnet™ Cloud, or to your machine.

Send the design to the mySewnet™ Cloud

Send directly to a mySewnet™ device

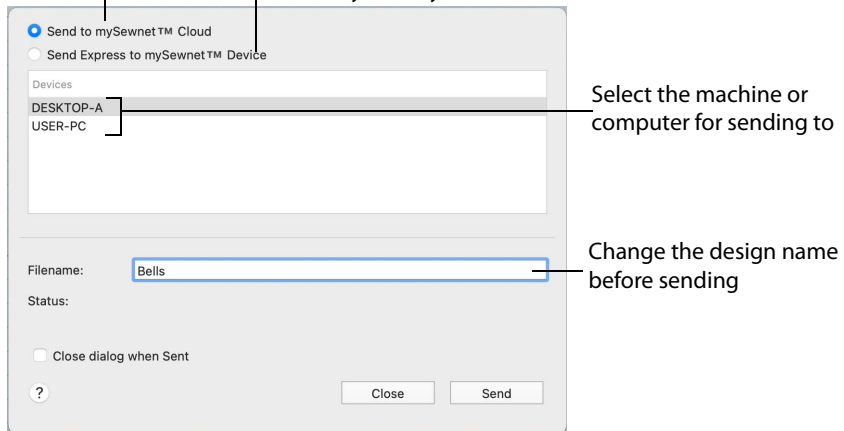

Send to mySewnet™ Cloud

Send the selected embroidery design to the mySewnet™ Cloud.

Send Express to mySewnet™ Device

Send the selected embroidery design direct to the mySewnet™ enabled machine or computer.

Note: Select the computer or machine from the list below.

Filename

You can change the name of the design before sending it.

Sending via mySewnet™

Sending from a Machine to mySewnet™ Embroidery

You can send an embroidery from a mySewnet™ enabled embroidery machine to mySewnet™ Embroidery on your computer. Adjust the embroidery, then return it to your machine for stitching.

To be able to send from your machine to mySewnet™ Embroidery, and to send to your machine with Send Express to mySewnet™ Device:

- mySewnet™ Connect must be running on the computer
- You must use a mySewnet™ enabled embroidery machine with the most recent updates installed
- The computer and embroidery machine must be signed in to the same mySewnet™ account.

Note: An embroidery moved from a machine to mySewnet™ Embroidery will not retain the special features from the embroidery machine, for example changing the words in lettering created on the machine, as it is sent as stitches. This is also true of designs sent in the other direction.

Send from an Embroidery Machine

- 1 Go to the embroidery machine.
- 2 Tap the Cloud button at the top and ensure that you are signed in to mySewnet™ .
- 3 Select embroidery mode, and then load an embroidery.
- 4 In the machine screen, choose the send to software option.
- 5 Select the computer to send to, then send the embroidery.
The embroidery will open in a new mySewnet™ Embroidery window.
- 6 When you have adjusted the embroidery, save the changes to your computer.
Note: You can name your computer in the mySewnet tab of mySewnet™ Configure. You can then use Send Express to mySewnet™ Device to return the edited embroidery to your machine for stitching out.

Note: When you send from your embroidery machine to mySewnet™ Embroidery, the embroidery may be sent to a window beneath the active maximized window. The mySewnet™ button flashes to indicate that a design has been sent.

Using Send Express to mySewnet™ Device

- 1 In the File menu, select Send.
- 2 In the Send dialog box, select your machine name from the list.
A message tells you that the design was sent.
- 3 On the machine, tap to accept the design from your computer.
- 4 Stitch out the design.

Note: You can use Send to mySewnet™ in the Finder to send embroideries to mySewnet™ . See the mySewnet™ Configure Reference Guide and Help.

mySewnet™ Connect

Use the mySewnet™ Connect module in the mySewnet™ Embroidery Software to access your mySewnet™ settings in mySewnet™ Configure.

Note: To change your mySewnet™ settings, see the mySewnet™ Configure Reference Guide and Help.

Use the mySewnet™ Connect menu to check the status of your mySewnet™ connection.

The System Tray Icon

When mySewnet™ Connect is running, it appears as an icon in the menu bar  at the top right of your computer screen. The icon shows whether or not communication is established with your machine as follows:



Communication established



No communication

- Click the icon to see the mySewnet™ Connect Menu.

Note: Communication is shown as established when a connection exists with mySewnet™.

Starting mySewnet™ Connect

mySewnet™ Connect is set to start automatically when you restart your computer. If it is not open, use the following steps.

- 1 Open mySewnet™ Configure .
- 2 On the Utilities tab, click Start mySewnet™ Connect . The mySewnet™ Connect icon  can now be seen in the menu bar.
- 3 To close mySewnet™ Connect, click the icon in the menu bar and in the mySewnet™ Connect menu click Quit.

mySewnet™ Connect Menu

Click the mySewnet™ Connect icon in the menu bar to see a menu of options.

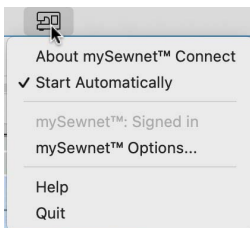



The menu tells you whether you are signed in to mySewnet™.

Note: For mySewnet™ the current status in mySewnet™ Configure is listed. If you have more than one machine, the first found is used.

- Select About mySewnet™ Connect to see the version number and copyright. (You will need this version number if you contact technical support at any time.)
- Select Start Automatically to select or deselect the automatic start when your computer starts.
- Select mySewnet™ Options to view the mySewnet tab in mySewnet™ Configure.
- Select Help to display help pages about mySewnet™ Connect.
- Select Quit to close mySewnet™ Connect and remove it from the menu bar.

Working with Protected Designs

Designs from the mySewnet™ Library are opened in a protected state, as indicated by a Library design  &  symbol in the FilmStrip.

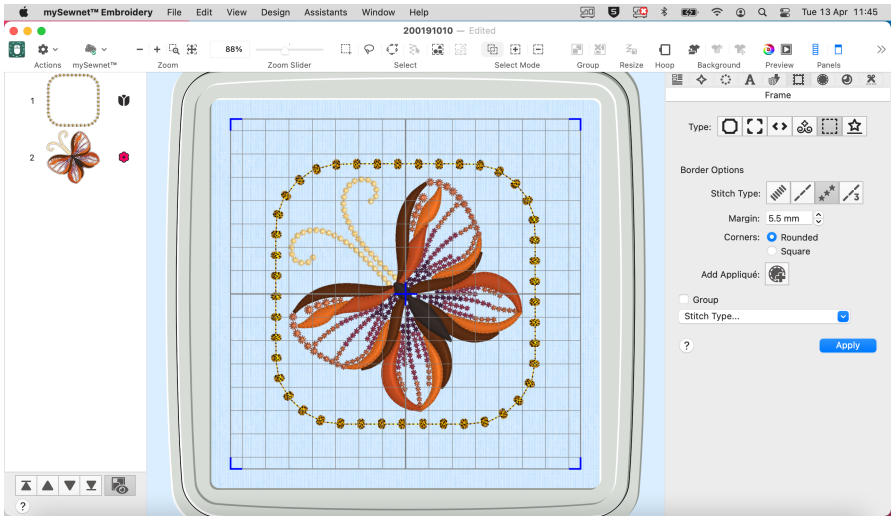

Opening and Inserting Protected Designs

Note: Protected designs can only be opened in mySewnet™ Embroidery or mySewnet™ Stitch Editor. They cannot be opened in any other module.

When you use File > Open to load a mySewnet™ Library design, or a project containing a Library design, the protected sub-designs are shown in the FilmStrip.

Note: If a project that includes a mySewnet™ Library design is opened without a mySewnet™ subscription present, the protected parts will not be loaded.

Saving and Exporting Protected Designs

- When you save protected projects with File > Save (or Save As) a protected file in .evp4 format is created.
- When you export protected projects with File > Export, the protected format .evp3 is used.

Note: You can only stitch out protected projects on a mySewnet™ Library enabled embroidery machine.

Working with a Protected Project

Any project that includes a mySewnet™ Library design becomes a partially protected project. The protected components can only be stitched out on mySewnet™ Library enabled machine with an active mySewnet™ Library subscription.

Printing a Worksheet

When you print a worksheet for a protected project, the words "Protected File" can be seen at the bottom of the worksheet.

Browsing Protected Designs

Designs from the mySewnet™ Library use the file extensions .evp3 or .evp4.

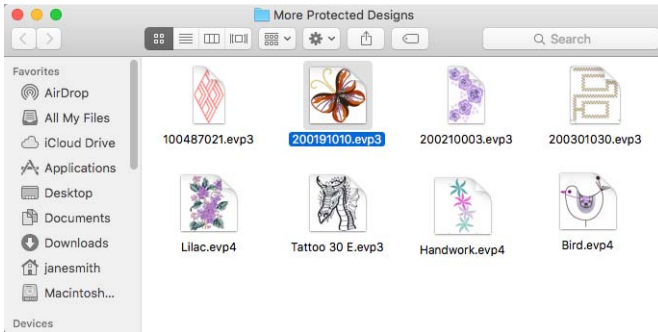

When in Icon view in the Finder, the Protected Design icon  can be seen.

To see more details for the design, use Column view or Quick Look.

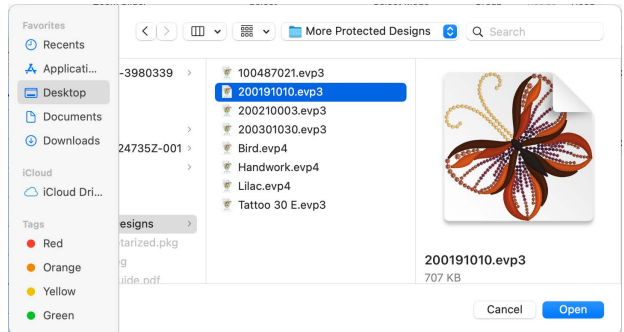

Rename

You can rename the document in the currently selected window.

- If the document has not been saved, the Save dialog is displayed so you can save your embroidery. See “Save” on page 32.
- If the document has been previously saved, you can rename the document in the application title bar.

Rename a document

- Choose File > Rename, then save or rename the document.

Move To

You can move a document from the folder it is saved in, to another folder.

- Choose File > Move To, then browse to the destination folder.

Revert To

Use Revert To to return to a previous version of your embroidery.

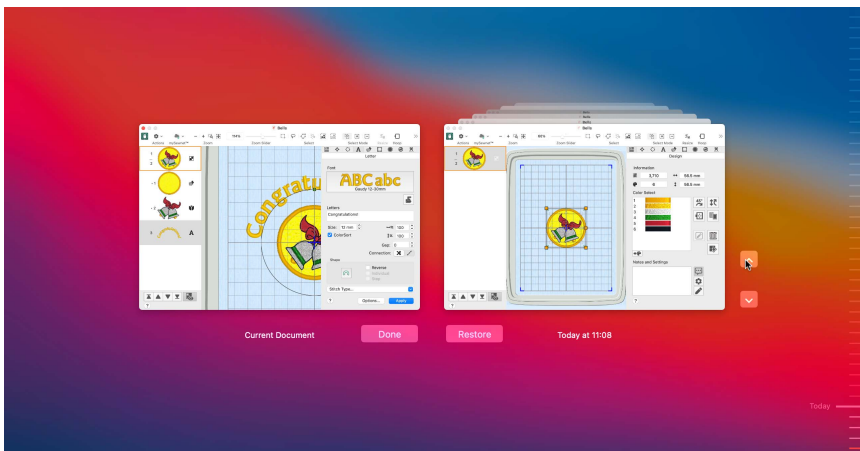

Use Revert To

- 1 Create an embroidery project using existing designs, text, frames and SuperDesigns.
- 2 Choose File > Save (or press ⌘S) to save the embroidery. See “Save” on page 32.
- 3 Change the embroidery.
- 4 Choose File > Save (or press ⌘S) to save the embroidery again.
- 5 Choose File > Revert To. All of the changes that you have made and saved can be selected on the screen.
- 6 Click Restore to go back to an older version, or Done to return without reverting,

Select the way you view your embroideries. Zoom in and out, switch between 3D View, Realistic 3D and 2D View, and use a grid for alignment. Load or create a background, then move and fade it as desired. Use the Design Player and Life View to view how your embroideries will stitch out, and in 3D with a real-world perspective.

View Mode

Select 3D View, Realistic 3D, or 2D View stitch display with View Mode.

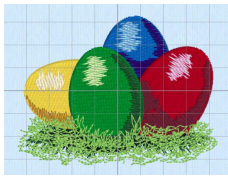

3D View 



Realistic 3D 

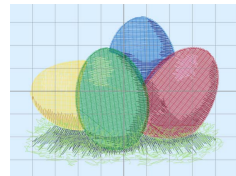

2D View 

See your embroidery in Standard 3D

Realistic 3D shows no box, grid or hoop



2D shows stitches as lines with no shading

3D View

Use 3D View to see embroideries, background and grid in standard 3D mode. The stitches of the embroideries have three-dimensional shading. All editing functions are available, and the selection box is shown.

To view embroideries in standard 3D

- Click the 3D View button  on the toolbar.
- Choose View > View Mode > 3D View Mode

Realistic 3D

Use Realistic 3D to view embroideries and background in 3D without selection boxes, grid or hoop. You can use the zoom commands, but some editing functions are not available.

To view embroideries in Realistic 3D

- Click the Realistic 3D button  on the toolbar.
- Choose View > View Mode > Realistic View Mode

2D View

Use 2D View to see the individual stitches in your embroideries as lines with no shading.

To view embroideries in 2D

- Click the 2D View button  on the toolbar.
- Choose View > View Mode > 2D View Mode

Note: Stitches are automatically displayed in 2D when you select the Modify window.

Grid

Use the grid to help align embroideries.

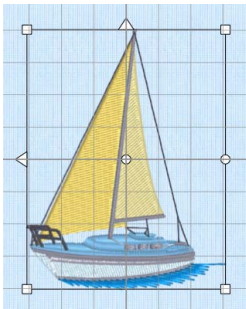

Grid On

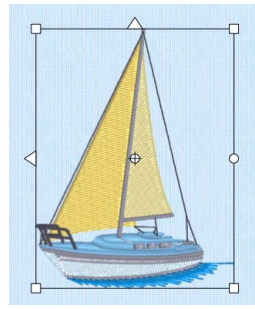

Grid Off

The apparent grid size varies, depending on the size of the embroidery and the zoom level. The grid is initially set at 10mm intervals. Adjust its size between 2mm and 50mm using Preferences.

To switch the grid on and off

- Choose View > Grid.
- Press .

Zooming In or Out

You can enlarge (zoom in) or reduce (zoom out) your view of the work area.

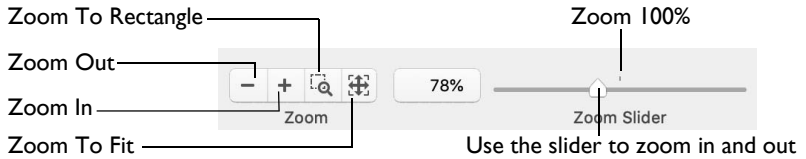

Zoom To Fit shows the hoop so that it fills the window. This is the default size. Click the center marker on the zoom slider, or press $\mathbb{A}1$ to see the embroidery at 100% or real size.

To Zoom In

- Click the Zoom In $+$ button on the toolbar.
- Choose View > Zoom > Zoom In.
- Press $\mathbb{A}+$
- Drag the zoom slider to the right.
- Use Pinch to zoom on a trackpad (close two fingers) to zoom in.
- Use Zoom To Rectangle  or Percentage Zoom to select your desired magnification.
- Control-click and choose Zoom > Percentage Zoom.

To Zoom Out

- Click the Zoom Out $-$ button on the toolbar.
- Choose View > Zoom > Zoom Out.
- Press $\mathbb{A}-$
- Drag the zoom slider to the left.
- Use Pinch to zoom on a trackpad (spread two fingers) to zoom out.
- Use Percentage Zoom to select your desired magnification.
- Control-click and choose Zoom > Percentage Zoom.

Using Zoom To Fit

- Click the Zoom To Fit  button on the toolbar.
- Choose View > Zoom > Zoom To Fit.
- Press $\mathbb{A}0$

Zoom To Rectangle



You can select the position and size of an area to zoom in on with Zoom To Rectangle.

To Select Zoom To Rectangle

- Click the Zoom To Rectangle  button on the toolbar.
- Choose View > Zoom > Zoom To Rectangle.

- Press ⌘*

Magnify an Area with Zoom To Rectangle

- 1 Select Zoom To Rectangle . The pointer changes to the Zoom To Rectangle pointer .
- 2 Drag a rectangle around the area you want to zoom in to.
- 3 Release the mouse button to zoom in. Zoom To Rectangle is automatically deselected after you have used it.



Pan

When zoomed in, move around the work area using pan.



Note: The scroll bars may only appear when you are scrolling. To always show the scroll bars, choose Apple Menu > System Preferences > General > Show scroll bars: Always.

- Drag the scroll bars.
- Swipe with one finger on a Magic Mouse, or two fingers on the trackpad to scroll in any direction.

Percentage Zoom

You can set zoom percentage levels for the active embroidery from 25% to 800%, with 100% being the real size of the embroidery.

Using Percentage Zoom

- Click Actions  on the toolbar and choose Zoom > Percentage Zoom.
- Control-click  and choose Zoom > Percentage Zoom.
- Choose a magnification level from the zoom menu:

⌘1	100%	Choose View > Zoom > Zoom 100%
⌘2	200%	Choose View > Zoom > Zoom 200%
⌘3	400%	Choose View > Zoom > Zoom 400%
⌘4	800%	Choose View > Zoom > Zoom 800%
⌘5	75%	Choose View > Zoom > Zoom 75%
⌘6	50%	Choose View > Zoom > Zoom 50%
⌘7	25%	Choose View > Zoom > Zoom 25%

Backgrounds

Use the Background tools to load a background or create a new background with the Background Assistant, to move a background, or to fade a background.

Load or create a background with the Background Assistant



Move the background

Fade the background

Note: The Background tools are only available after a Background has been selected in the Background Assistant. See “Background Assistant” on page 56.





Background On shows the picture in the background.

Drag the slider to fade the colors in the background picture (here by 50%).

Background Off hides the picture.

Load Background

Use Load Background  to start the Background Assistant, where you can load a background or create a new background for your embroideries.

- Click the Load Background  button on the toolbar.
- Choose View > Load Background.
- Press \uparrow ⌘K

The Background Assistant opens. See “Background Assistant” on page 56.



Background Visibility

Use Background Visibility  to open a pop-up menu and select one of the background visibility options.

- Background On shows the background at full visibility. See “Background On” on page 54.
- Background Off hides the background. See “Background Off” on page 54.
- Fade Background (or ⌘K) opens the Fade Background dialog where you can set the visibility for the background garment or fabric. See “Fade Background Dialog” on page 55.
- Click the Background Visibility  button on the toolbar, then choose Background On, Fade Background or Background Off from the pop-up menu.

Note: You can also set the visibility of the background with the Background Visibility menu options. See “Background Visibility” on page 56.



Move and Rotate Background

Use Move and Rotate Background  to move the background that you have placed behind your embroideries. The mouse pointer changes to a four-headed arrow .

Move a Background

- Click the Move Background  button on the toolbar.
- Choose View > Move Background.
- Press \backslash ⌘ K

Using Move Background

- 1 Click the Move Background button . The mouse pointer changes to a four-headed arrow . Alternatively, choose View > Move Background (or press \backslash ⌘ K).
- 2 Drag the garment or fabric background around the hoop or project area.
- 3 When the background is in the desired location, Control-click to deselect the function.

Background On

View the background at full visibility.

To use Background On

- Click the Background Visibility  button on the toolbar, then choose Background On in the pop-up menu.
- Control-click and choose Background Visibility > Background On.
- Choose View > Background Visibility > Background On.

Background Off

Hide the background.

Note: To remove the background, use Remove Background. See “Remove Background” on page 56.

To use Background Off

- Click the Background Visibility  button on the toolbar, then choose Background Off in the pop-up menu.
- Control-click and choose Background Visibility > Background Off.
- Choose View > Background Visibility > Background Off.

Fade Background Dialog

Use the Fade Background dialog to set the visibility for the background garment or fabric.

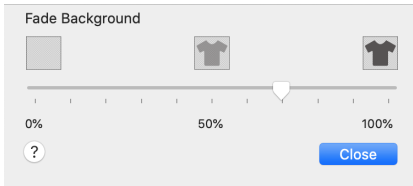

To open the Fade Background dialog

- Click the Background Visibility  button on the toolbar, then choose Fade Background in the pop-up menu.
- Control-click and choose Background Visibility > Fade Background.
- Choose View > Background Visibility > Fade Background.
- Press ⌘K

Use Fade Background

- 1 Click the Background Visibility  button on the toolbar, then choose Fade Background in the pop-up menu.
Alternatively, Control-click and choose Background Visibility > Fade Background, or press ⌘K.
- 2 Drag the slider to set the background visibility to any point between 0% (background off) and 100% (background fully on).
As you drag the slider the appearance of the background changes.
- 3 Click Close when the background is at the desired fade level.

Background Visibility

You can set visibility for the active background to a range of levels, including 100% (On) and 0% (Off).

Using Background Visibility

- Choose View > Background Visibility and select a background visibility option.
- Choose a visibility level from the Background Visibility menu:

Off	Choose View > Background Visibility > Background Off
10%	Choose View > Background Visibility > Fade Background to 10%
20%	Choose View > Background Visibility > Fade Background to 20%
30%	Choose View > Background Visibility > Fade Background to 30%
40%	Choose View > Background Visibility > Fade Background to 40%
50%	Choose View > Background Visibility > Fade Background to 50%
60%	Choose View > Background Visibility > Fade Background to 60%
70%	Choose View > Background Visibility > Fade Background to 70%
80%	Choose View > Background Visibility > Fade Background to 80%
90%	Choose View > Background Visibility > Fade Background to 90%
On	Choose View > Background Visibility > Background On

Remove Background

Use Remove Background to remove a background that you have placed behind your embroideries.

Delete a Background

- Choose View > Remove Background.

Background Assistant

Use the Background Assistant to load an existing background, or create a new background. Preview the embroideries you have designed on a garment, home decor item, quilt block, fabric, or other background.

Note: Use Realistic 3D  to view embroideries and backgrounds in 3D without a grid, hoop or selection box.

Real Size Backgrounds

When you add a new background to your collection, you provide a measurement so that it can be matched to the size of your embroideries. The garment, quilt block and fabric backgrounds supplied with mySewnet™ Embroidery have already been set to real size.

Choose Background

Use the Choose Background page of the Background Assistant to select whether to load a saved background, or to create a new background for your embroidery.

Load a saved background

Load a picture to create
a new background

Select a saved background type

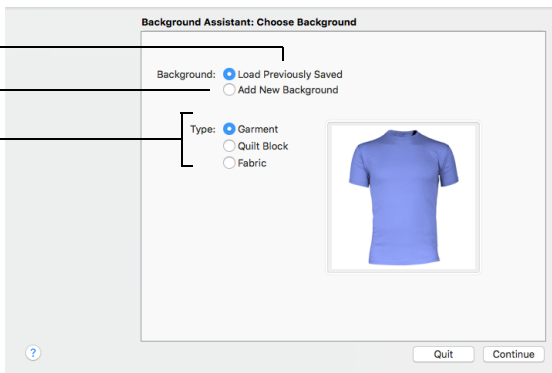

Load a Previously Saved Background

- Select Load a Previously Saved Background to browse to a saved background file.

Add a New Background

- Select Add a New Background to browse to a picture on your computer.

Type

- Select a background type to load or create: Garment, Quilt Block or Fabric.

Continue

- If you selected Add a New Background, go to the Choose Picture page.
- If you selected Load a Previously Saved Background, go to the Load Background page.

Load Background

Use the Load Background page of the Background Assistant to load a saved background. The Load Background page appears if you selected Load a Previously Saved Background in the Choose Background page.

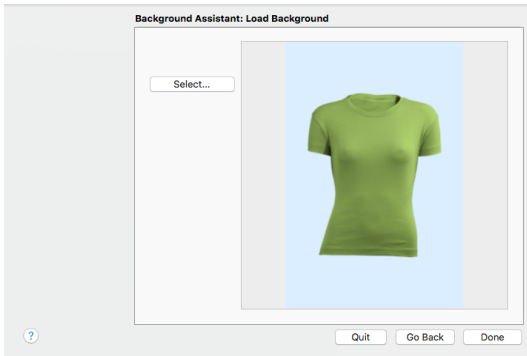

Select

- Click Select to choose a background in the Background Viewer, then browse to the desired folder and background.
Note: The background type (Garment, Quilt Block or Fabric) depends on your choice in the Choose Background dialog.

Done

Close the Background Assistant and load the background in the work area.

Select a Background

- 1 In the Choose Background page of the Background Assistant, select Load Previously Saved Background.
- 2 Select a Background Type: Garment, Quilt Block or Fabric.
- 3 Click Continue. The Load Background page appears.
- 4 Click Select, and browse to the desired folder in the Background Viewer.
Note: The available folders are for the background Type that you selected in the Choose Background page, for example Bags & Hats.
- 5 Click on a background.
- 6 Click OK to open the background, and to close the Viewer. The selected background is displayed in the Load Background page.
- 7 Click Done to close the Background Assistant and load the background in the work area.
Note: Click Quit to exit without selecting a background.

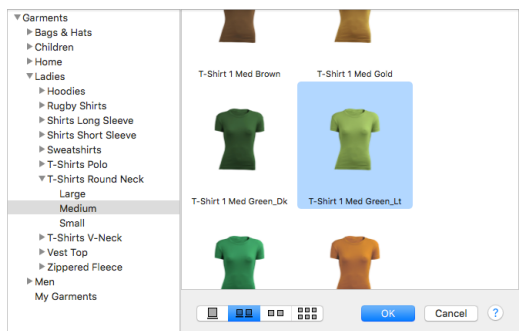

Choose Picture

Use the Choose Picture page of the Background Assistant to select a picture to create a background.

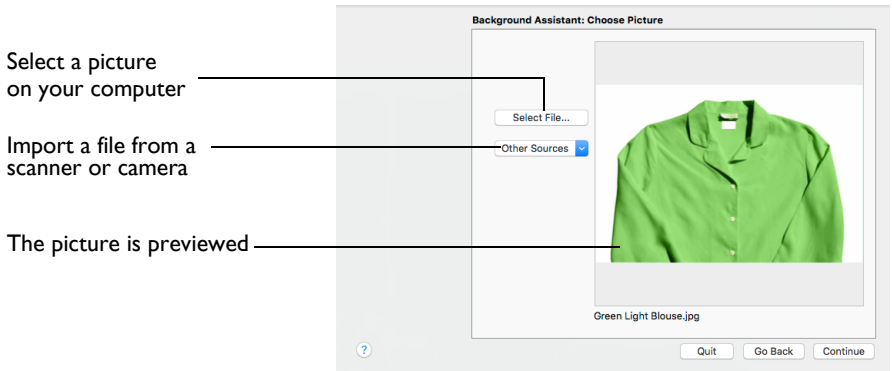

Select File

- Click Select File to select a picture to create a background. Browse to one of the Samples subfolders, such as: mySewnet/Samples/Embroidery/Pics. Alternatively, browse to a folder elsewhere on your computer.

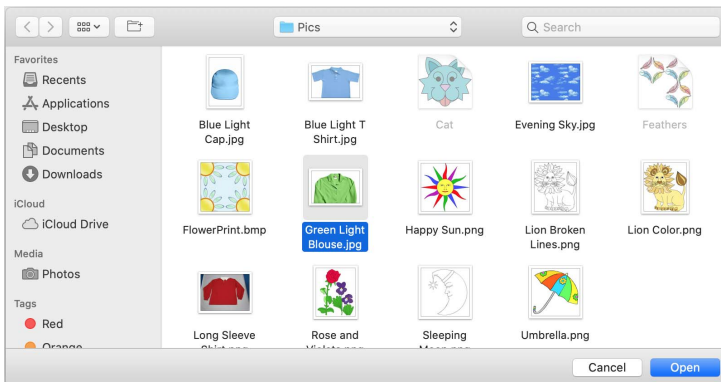

The following popular image file formats may be loaded: Bitmap (.bmp), Encapsulated PostScript (.epi, .eps), Graphics Interchange Format (.gif), JPEG-JFIF Compliant (.jpg, .jfif, .jpeg), JPEG 2000 (.jp2, .jpf), JPEG Multi-Picture Object (.mpo), Photoshop (.psd), Portable Document Format (.pdf), Portable Network Graphics (.png), Postscript (.ps), Tagged Image File Format uncompressed (.tiff, .tif), Camera RAW (.raw & many others), High Dynamic Range (.exr, .hdr), High Efficiency Image Format (.heic).

These additional formats can also be loaded: Apple Icon (.icns), Fax (.fax & many others), Linux Icon (.xbm), Macintosh Picture (.pct, .pic, .pict), MacPaint (.mac,

.pnt, png), Microsoft Icon (.cur, .ico), Silicon Graphics (.rgb, .sgi) and Truevision TGA (.targa, tga).

Select a Picture

- 1 Click Select File. The Open dialog appears.
- 2 Browse to the desired folder.
- 3 Click on a picture.
- 4 Click Open to open the picture onto the Choose Picture page, and to close the dialog. Click Cancel to exit without selecting a picture.
- 5 Click Continue to prepare your picture as a background.

Continue

Go to the Rotate & Crop Picture page.

Go Back

Return to the Choose Background page.

Rotate and Crop Picture

Use the Rotate and Crop Picture page of the Background Assistant to prepare a garment or quilt block picture when creating a background.

Correct the perspective in the picture

Select the whole picture

Change the picture angle

Automatically exclude the picture background

Adjust the crop lines as desired

Zoom in and out

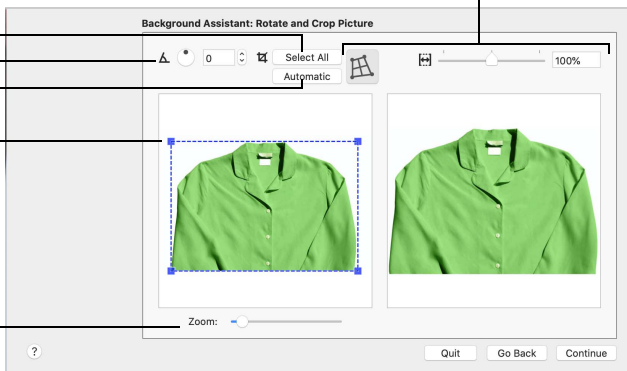

If required, rotate the picture to any angle from 0 to 359 degrees. For example, this is useful for straightening scanned pictures.

When the picture is rotated between the 90 degree steps, the picture is made larger and the detected background color is added. If there is no distinctive background color, white is used.

Select All: Select the whole of the picture.

Automatic: Select the smallest rectangle that includes all colors that are not the background color.

Note: The size of the crop box may vary if the picture is rotated.

Rotate and Crop a Picture

- 1 Drag the rotational slider to rotate the picture to the desired angle. Alternatively, enter a number in the rotation angle number box, or use the arrows to increase or decrease the angle of rotation.
- 2 Drag the handles on the crop area boundary line to select the desired part of the picture. Hold the Shift key while dragging to resize the rectangle proportionally. Hold the Option key while dragging to resize the rectangle without moving its center.
- 3 Drag anywhere inside the crop box to move the crop box.
Note: If you need to expand a crop box again, make sure it is not touching the edge of the frame, as this will stop it expanding.
- 4 If desired, click Automatic to select the crop lines automatically, or click Select All to use the whole of the picture.

Perspective Correction

To remove the effects of perspective in a picture, or to correct skew, select Perspective Correction . When using Perspective Correction, the crop handles are red.

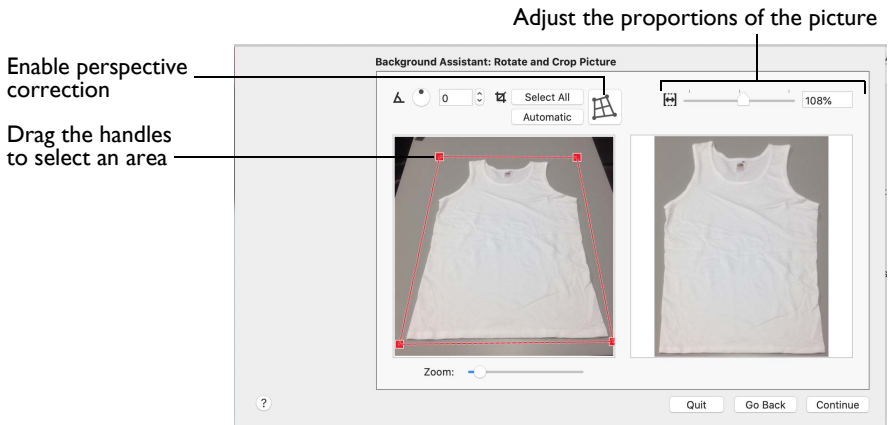



Drag the red handles so that the crop lines frame the picture. Use the Zoom tools to view the outline of the picture more clearly.

Note: When taking a picture, hold the phone or camera so as to avoid reflected light and shadow on your subject.

Stretch Picture

Drag the Stretch Picture  slider to make the picture in the Preview wider or narrower.

Change the Perspective in a Picture

- 1 In the Rotate and Crop Picture page, ensure that Perspective Correction  is selected.
- 2 Move the pointer over one of the red crop handles in the corner. The pointer changes to a diagonal double-headed arrow .
- 3 Move the red corner handles so that the crop lines frame the picture. The angle of the adjoining crop lines changes. A version of the picture with the perspective corrected appears in the Preview area.
Note: When taking a photo for a background, hold the phone or camera so as to avoid reflected light and shadow on your subject.
- 4 Drag the Stretch Picture  slider to correct the proportions of the picture.

Zoom

Use the Zoom bar to change the view of the picture. Zoom in (drag the slider to the right) to magnify the view. Zoom out (drag the slider to the left) to shrink the view.

When zoomed in, use the scroll bars or swipe to move around.

Go Back

Return to the Choose Picture page.

Continue

Go to the Set Size page.

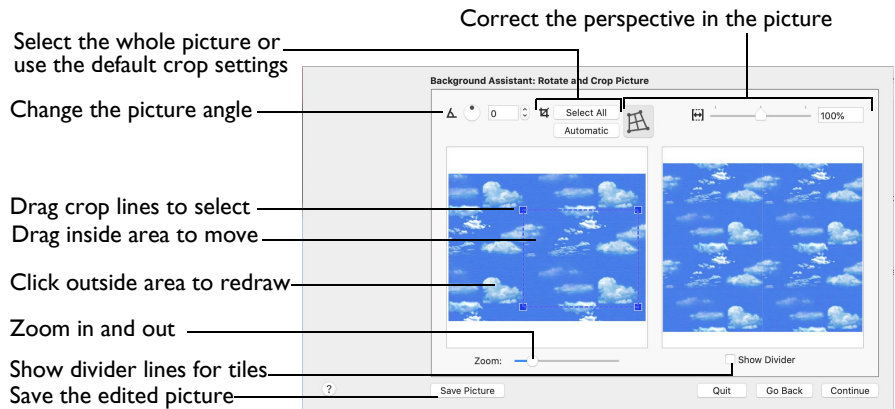

Rotate and Crop Picture - Fabric

Use the Rotate and Crop Picture - Fabric page of the Background Assistant to prepare a fabric sample picture when creating a background.



Adjusting the Crop Area

Initially, about half the area of the picture is selected from the middle of the picture, as shown by the dashed box in the picture on the left. The preview on the right shows four copies of the selected fabric area tiled together. The tiled preview changes dynamically as you change the crop area.

- To adjust the crop area, position the mouse over the crop boundary until a double-headed arrow  appears, then drag to move the boundary line.
- To move the crop area, position the mouse inside the crop boundary until a hand pointer  appears, then drag to move the whole rectangle.
- To redraw the crop area, drag outside the crop boundary to draw a new rectangle, which can then be adjusted as required.

To see where the four sections of the background are joined, select the Show Divider option. Dashed lines show where the tiled sections will be joined. This is useful for patterned fabric, to ensure the pattern repeats as desired.

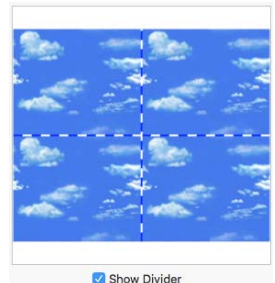

When the desired area is selected, click Continue.

Rotate

Rotate  the picture from 0 to 359 degrees. Adjust the picture angle as desired. This is often necessary with scanned pictures.

- Enter the desired Rotation angle  or use the up/down arrows to change the angle. The preview shows the effect.

Note: When the picture is rotated between the 90 degree steps, the picture is made larger and white background is added.

Select All and Automatic

Use **Select All** to select the whole of the picture. Use **Automatic** to set the crop lines back to the default position for the current picture.

Perspective Correction

To remove the effects of perspective in a picture, or to correct skew, select **Perspective Correction** . When using **Perspective Correction**, the crop handles are red.

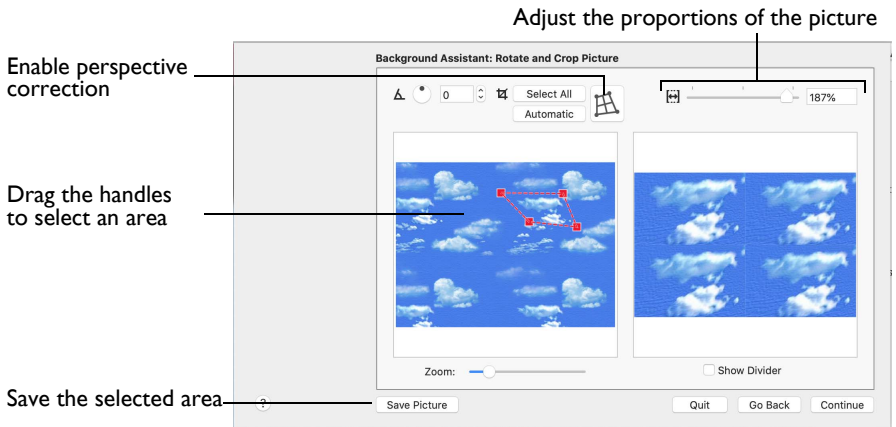

Drag the red handles so that the crop lines frame the picture. Use the **Zoom** tools to view the outline of the picture more clearly. Drag the **Stretch Picture**  slider to make the picture in the **Preview** wider or narrower. Use **Save Picture** to save your edited picture.

Zoom

Use the **Zoom** bar to change the view of the picture. **Zoom in** (drag the slider to the right) to magnify the view. **Zoom out** (drag the slider to the left) to shrink the view.

When zoomed in, use the scroll bars or swipe to move around.

Go Back

Return to the **Choose Picture** page.

Continue

Go to the **Set Size** page.

Set Size

Use Set Size to enter a real measurement of the garment or fabric so that it is displayed at real size when it is used as the background. The garment or fabric is shown in the preview.

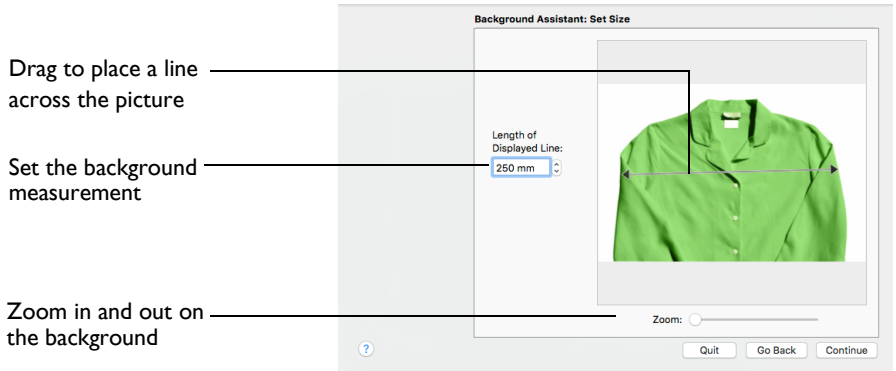

Measure the Picture

- 1 Drag the arrows at either end of the gray line to place a line across the picture. This should match a measurement you have made across the same area of the real garment or fabric.
Note: The length can be from 10mm to 1000mm.
- 2 Click the arrows for height and width to change the line measurement. Alternatively, enter a size in the number box.
- 3 Check that the line and the length matches the measurement you made of the real garment or fabric. If desired, drag the arrows to place a new line and re-enter the line length.
- 4 When the line is measured correctly, click Continue.

Zoom

Use the Zoom bar to change the view of the embroidery. Zoom in to magnify the view. Zoom out to shrink the view.

When zoomed in, use the scroll bars to move around.

Continue

Go to the Set Background Name page.

Go Back

Return to the Rotate and Crop Picture page.

Set Background Name

Use Set Background Name to save the finished background in a category and give it a name. The categories are the folder names that you see when browsing for existing backgrounds.

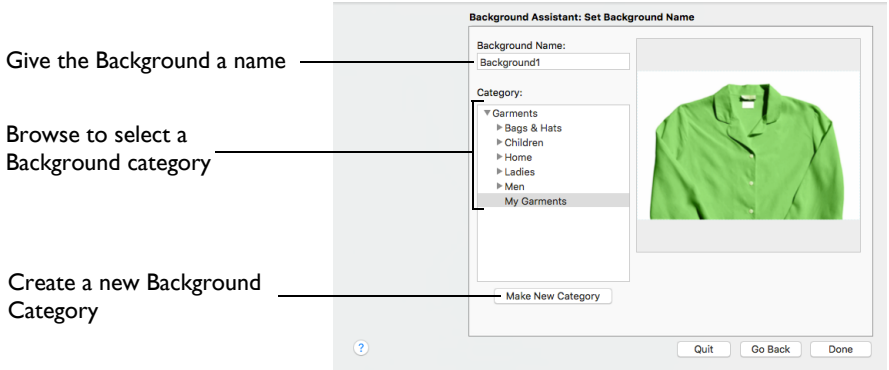

Background Name

If you used an existing picture, the picture name is shown by default as the name for the new background. If you scanned a new picture, it will not have a name so you will need to enter a name.

- Enter a name for the background in the text box.

Category

Select a Category.

- Save the background in the MyBackgrounds folder, or browse to another backgrounds folder.

Make New Category

Create a new Category within the selected Category. Enter a name for the new Category.

Note: For example, when adding a Garment background that is a shirt, you might add a category called Shirts to the My Garments category. This will create a subfolder called 'Shirts' within the 'My Garments' folder.

Zoom

Use the Zoom bar to change the view of the embroidery. Zoom in to magnify the view. Zoom out to shrink the view. When zoomed in, use the scroll bars to move around.



Go Back

If desired, use the Back button to go back through the Background Assistant and modify settings before previewing the design again.

Done

Click Done to save the new background with the specified name in the specified Category and close the Background Assistant. The new background is displayed in the work area.

Create a Garment in the Background Assistant

- 1 Click the Load Background  button on the toolbar. The Choose Background page of the Background Assistant appears.
- 2 Select Add New Background under Background, and Garment under Type.
- 3 Click Continue and the Choose Picture page appears.
- 4 Click the Select File button.
- 5 In the Finder window browse to mySewnet/Samples/Embroidery/Pics.
- 6 Click the red long sleeved shirt to highlight it.
- 7 Click Open to load the picture. The picture 'Long sleeve shirt.png' is loaded onto the Choose Picture page, with its name shown below the preview area.
- 8 Click Continue and the Rotate and Crop Picture page appears. The angle does not need to be changed, so do not rotate the picture.
- 9 Click Perspective Correction . The crop handles become red.
Note: Use Perspective Correction to remove the effects of perspective in a picture.
- 10 The picture on the left has a dashed outline around the area of the picture to be cropped. Move the mouse over the handle at the bottom right of the dashed crop box so that the pointer becomes a double-headed arrow.
- 11 Drag both of the two bottom red handles so that the bottom crop line runs parallel to the bottom of the shirt. .
Note: When you take a picture for a garment, hold the phone or camera so as to avoid reflected light and shadow on your subject.
- 12 Drag the red handles at the top to remove the effects of perspective in the picture of the shirt in the Preview.
- 13 Use the Stretch Picture  slider to adjust the width of the picture in the Preview.
- 14 When you are happy with the appearance of the shirt in the Preview, click Continue. The Set Size page appears, to set a size for the garment.

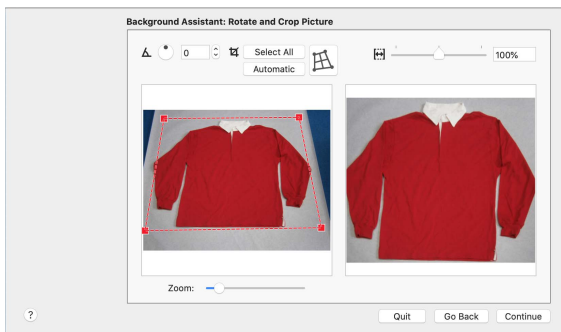
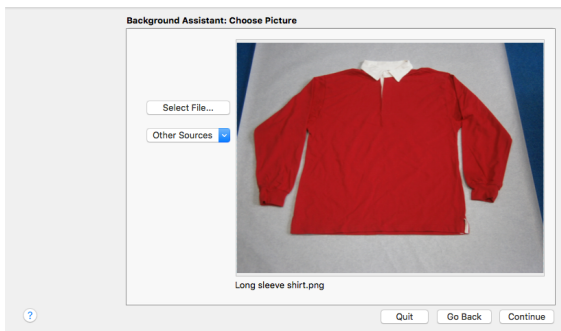

15 Drag to adjust the arrows on the measuring bar, so the line goes from the left edge of the body of the shirt to the right edge.

16 In the 'Length of displayed line' text box enter 550mm. The measurement and the measurement line are both shown.

Note: If you position the arrow pointer over the box the length is shown in inches.

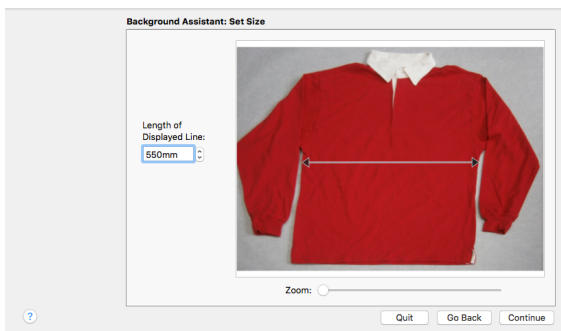

17 Click Continue and the Set Background Name page appears.

18 In the Garment Category box, ensure that My Garments is the selected category.

19 In the Background Name text box change the name to "Long sleeve shirt".

20 Click Done. Your new background is loaded into the work area.

21 Drag the Zoom Slider to the left so that you can see the whole shirt.

22 Click Move and Rotate Background .

23 Drag the background so that the hoop is at the top right of the shirt.

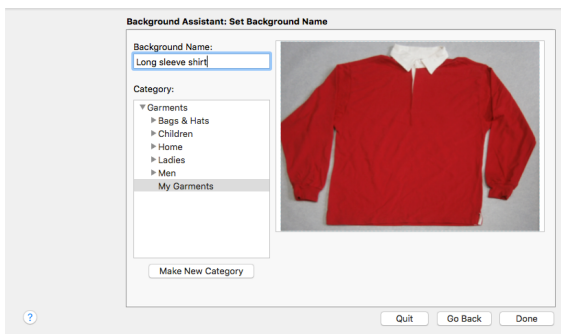

24 Choose File > Insert.

25 Browse to the folder mySewnet/Samples/Embroidery/Stitch.

26 Select the embroidery 'Champion Dad'.

Alternatively, use the embroidery you created in "Create a Framed Badge: Champion Dad" on page 455.

27 Click Open to load it into the work area on the shirt.

28 In the toolbar, click Realistic 3D  to view the embroidery on the shirt.



Life View

Use Life View  to show how an embroidery exported from the project will look in 3D with real-world perspective. Zoom in to see detail, and move and rotate the embroidery in a three-dimensional view. All parts of the embroidery that are within the hoop area are shown, whether or not they are selected.

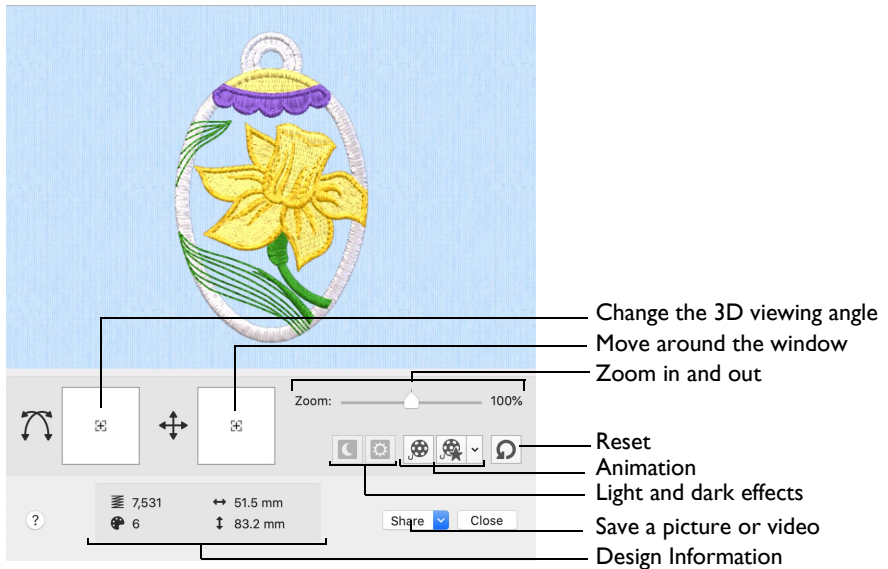

Use Life View  at any time when you want to see the design with no grid, stitches selected, or markers displayed, and when you want to see the effects of glow in the dark and solar reactive threads.

- Any background garment, quilt block or fabric is shown, together with appliqué fabric, if present.
- Decorations are shown, but not their placement stitches.

To Select Life View

- Click the Life View button  on the toolbar.
- Choose View > Life View.
- Press \uparrow ⌘ Y

Position

Use the position  slider to move to another part of the Life View window.

- Drag the cross marker in the center of the box to view the desired part of the embroidery, using the zoom slider to control the magnification.

Rotation

Use the rotation  slider to view the stitching in the embroidery in 3D.

Note: Use the zoom and position sliders to select the part of the embroidery to view.

- Drag the cross marker in the center of the box to change the angle at which the embroidery is viewed, and allow you to visualize the project in varying real-world views.
- Alternatively, drag directly in the embroidery preview area to change the angle of view.

Zoom

Use the zoom slider to change the magnification of the embroidery. The box below the zoom bar displays the current magnification.

Note: When zoomed in, use the position slider to move around the embroidery.

- Drag the slider to the right to magnify the view of the embroidery, and to the left to shrink the view of the embroidery.
- Click the marker in the center of the zoom bar (100%) to view the embroidery at a magnification as close as possible to the Real Size setting you chose in mySewnet™ Configure.

Design Information

View the dimensions (Width ↔ and Height ↓), the number of stitches ≡ and the number of colors ● in the embroidery.

Glow in the Dark

Use Glow in the Dark ☑ to view the effect of using glow in the dark threads. The preview darkens to simulate the lights dimming, and the glow in the dark threads are shown in their luminescent colors.

Note: Glow in the Dark is only available if glow in the dark thread colors are present in the design.



- Click Glow in the Dark ☑ to view the effect of luminescent threads.

Solar Reactive

Use Solar Reactive  to view the effect of using photochromic threads. The preview simulates the sun shining on the design, and the photochromic threads change shade to show the colors they become in sunlight.

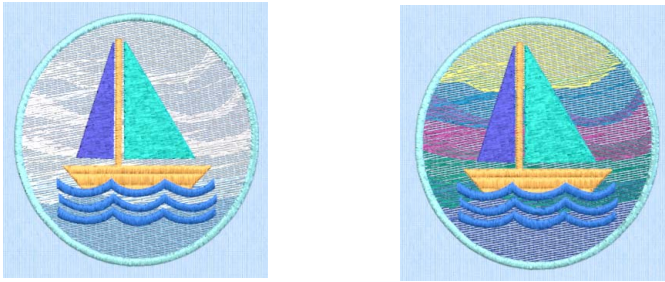

Photochromic threads change color in sunlight.

Note: Solar Reactive is only available if photochromic thread colors are used in the design.

Play Demo

Use Play Demo  to animate the preview and show the embroidery at different angles automatically.

- Click Play Demo  to start and stop the animation.

Play My Demo

Use Play My Demo  to animate the preview using your own demo. Use the menu options to add the current position as a point in the demo, or reset to create a new demo.

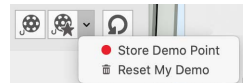

The My Demo animation is used for Life View in all mySewnet™ Embroidery Software apps. It is stored in the AnimationPath.txt file in the [User]/Library/ApplicationSupport/mySewnet/Embroidery/System folder.

Note: Copy this file to another location as a backup before creating additional My Demo animation paths for Life View.

- Click Play My Demo  to start and stop your saved animation.
- Choose Play My Demo > Store Demo Point to save a point for your demo.
- Choose Play My Demo > Reset My Demo to create a new demo.

Create Your own Demo

- 1 Adjust the window to the desired position and rotation.
- 2 In the Play My Demo pop-up menu, choose Store Demo Point.
- 3 Adjust the window again, and store more demo points.

Note: To start again from the beginning, in the Play My Demo pop-up menu, choose Reset My Demo.

- 4 When complete, select Play My Demo to see a preview animation between the stored positions.
- 5 Click Play My Demo  to start and stop the saved animation.

Reset

Use Reset  to set Rotation, Position and Zoom back to the default settings.

Share

Use Share to save a picture or video of your design. See “Share Picture” on page 74 and “Share Video” on page 75.

- Choose Share > Share Picture to share a picture.
- Choose Share > Share Video to share a video.

Design Player

Use Design Player to play through the stitches in the embroidery project as if it was being stitched from an exported embroidery. All parts of the embroidery project that are within the hoop area are shown, whether or not they are selected. The current Optimize for Sewing settings from mySewnet™ Configure are used.

Note: All the designs in a multipart embroidery are shown in the Design Player. This is therefore a good way to see the whole project after adjusting stitches in one of the designs.

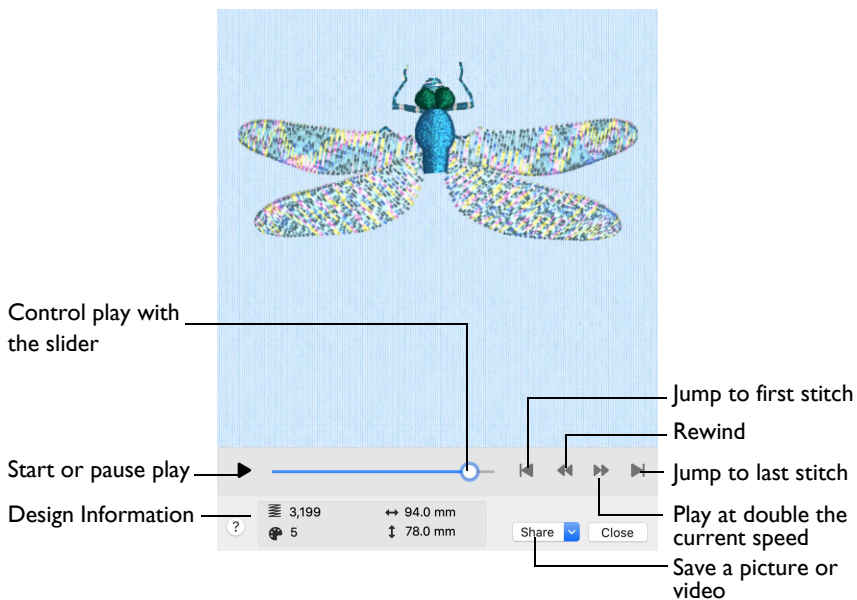

Embroideries that are outside the hoop (within a selection box that has round corners) are not shown in the Design Player.

Note: If an embroidery contains a felting needle, the project will be shown "flipped", as it would actually be stitched.

Share



Use Share to save a picture or video of your design. See "Share Picture" on page 74 and "Share Video" on page 75.

- Choose Share > Share Picture to share a picture.
- Choose Share > Share Video to share a video.

To Select the Design Player

- Click the Design Player button  on the toolbar.
- Choose View > Design Player.
- Press ⌘Y

Using the Design Player

- 1 Choose File > Insert.
- 2 Browse to mySewnet/Samples/Embroidery/Stitch.
- 3 Scroll down to "Dragonfly 2.vp4".
- 4 Click to load the embroidery into the work area.
- 5 Click Design Player . Alternatively, choose View > Design Player or press ⌘Y. The Design Player dialog opens and the embroidery is shown being stitched out.
- 6 Use the Play button  at the bottom left to start playing through the stitches in the embroidery.
- 7 Use the controls to play forwards or backwards through the embroidery at different speeds (each time you click the speed doubles), jump to the start or end of the stitches, and stop at any time.

Share Picture

Save a picture of your design.

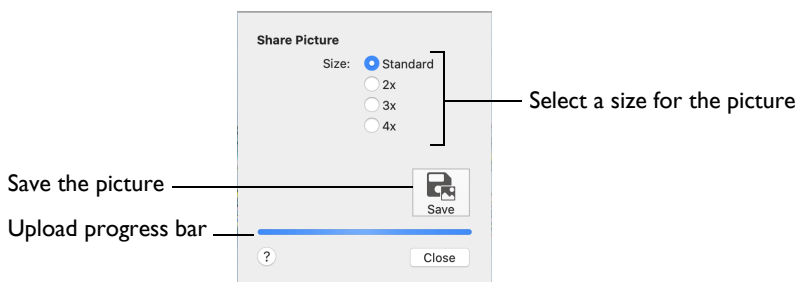

Select a size for the picture, then save the picture to your computer.

Note: Standard size is the size of the picture in Design Player or Life View.

Save

Use Save to save the picture to your computer in the Save As dialog. The default file name is the same as the design.

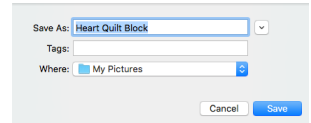

The following file formats may be saved: JPEG Low Quality (.jpg), JPEG High Quality (.jpg), Tagged Image File Format uncompressed (.tif) and Portable Network Graphics (.png).

Share Video

Save a video of your design.

Name the video and select its size, quality and speed. Then save it to your computer. A progress bar is displayed while the video is created.

The higher the image quality, the slower the speed of upload and download.

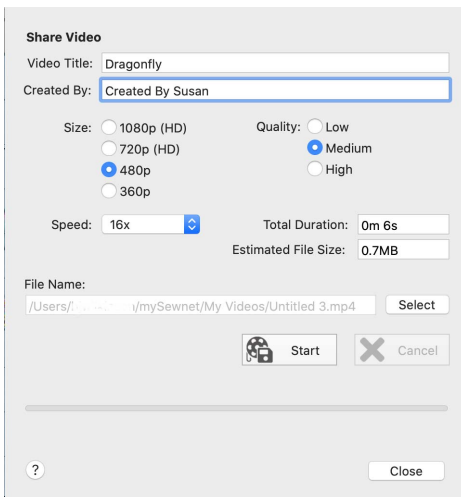

Video Title and Created By

The video title and the name of the creator are used on the opening frames of the video. Enter the name of the video, and the name of the creator.

Size

The size of the moving image in pixels. The higher numbers create a higher quality video. Choose from 1080p (HD), 720p (HD), 480p and 360p. The initial setting is 480p.

Quality

The bit rate, or speed of data transfer. Choose between Low, Medium and High. The initial setting is Medium.

Speed

Set the speed of the Design Player for the video. Choose from Standard, 2x, 4x, 8x, 16x, 32x, 64x, and 128x. The initial speed is 16x.

Note: This option is only available for videos created from Design Player.

Video Information

The Total Duration of the video in minutes and seconds, and the estimated file size in MB are displayed. The duration and size vary according to the Size, Quality and Speed of the video.

File Name

Select a folder and name for the video file. Click Select to browse to a different folder on your computer.

Start and Cancel

Click Start to create your video, using the settings that you chose above. A progress bar shows during the creation of the video, with an estimate of the creation time. Click Cancel to stop the video creation.

Note: All other functions in the dialog box are dimmed (grayed out) during video creation.

This chapter describes how you can change thread colors, how you can select thread colors to match colors on your computer, and how to reduce the number of thread changes before stitching out.

Design Window

Use the Design window to change colors in embroideries, edit the notes and settings, rotate and resize.

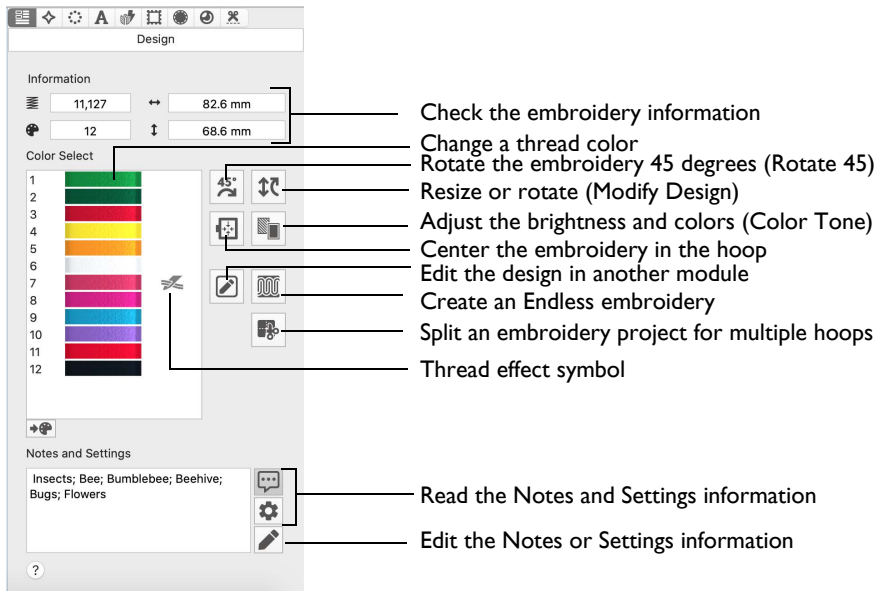

To Open the Design Window

- Click Control Panel , then click Design .

To learn how to	Go to
Change a thread color	See “Changing a Thread Color” on page 79.
Choose a color to use for a thread	See “Select a Color for a Thread” on page 83.
Check the embroidery information	See “Design Information” on page 13.
Read and edit the Notes and Settings	See “Notes and Settings” on page 27.
Rotate the embroidery by 45 degrees	See “Rotate 45” on page 98.
Resize or rotate the embroidery	See “Modify Design” on page 99.

To learn how to	Go to
Center the embroidery in the hoop	See “Center In Hoop” on page 100.
Adjust brightness and colors	See “Color Tone” on page 84.
Minimize the number of color changes	See “ColorSort” on page 86.
Split a large embroidery automatically for a hoop you select.	See “Split Project” on page 141.
Create a continuous sequence of embroideries for a border.	See “Endless” on page 112.

Color Select

The Color Select area in the Design window shows the order in which the thread colors are used in the selected design. The group of stitches using a particular thread color is called a color block.

The Color Select area can be used to change thread colors and, in the Modify window, to hide and show the stitches in any of the color blocks. The first color in the embroidery is at the top of the list, followed by all the thread color blocks. The numbers show the order in which the colors are used, and the samples show solid blocks of each thread color in 3D.



There can be unlimited color changes in an embroidery saved in .vp4.

Note: You can move and merge color blocks in the Modify window .

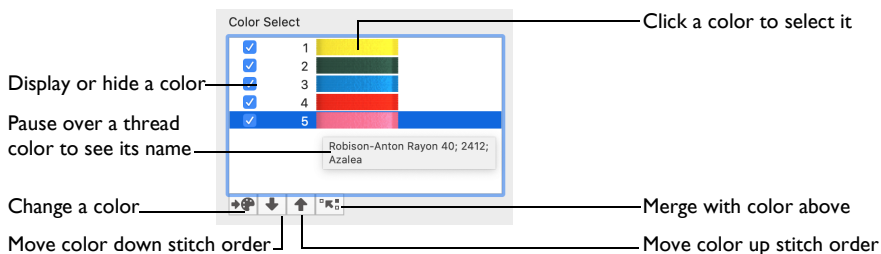

Colors can be added or changed to any color available in the standard thread ranges, and an unlimited number of My Threads ranges. My Threads ranges, created in mySewnet™ Thread Cache, can contain threads copied from the standard thread ranges, plus custom threads based on existing threads or added as completely new threads.

To Change a Thread Color

- Click a thread color in the Color Select area. The Color Selection Dialog opens.

Color Selection Dialog

The Color Selection dialog appears when you click a thread color in the Color Select area. You may choose any thread shade from the available thread manufacturers' palettes (for instance, Robison-Anton Rayon 40 or Sulky Rayon 40) or a thread you have added to My Threads.

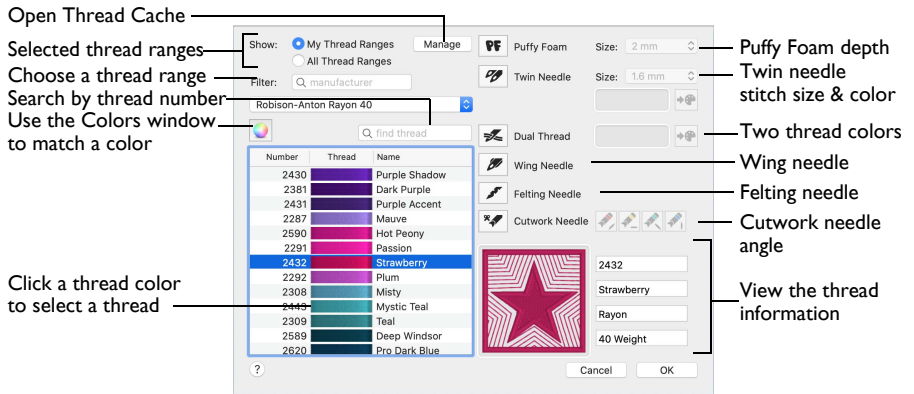

When you select a new thread color, the Color Select area shows the color change, and the work area shows the block of stitches in the new color.

To Choose a Thread Range

- Select from the pop-up menu of thread ranges or My Thread Ranges.
- Search for a manufacturer, then select from the list of thread ranges.

To Select a Thread Color

- Select colors by visual selection or by entering a shade number.
- Click the Colors  button, and in the Colors window choose a pencil coloring to select the nearest matching thread color.

Changing a Thread Color

- 1 Hover the pointer over a color you wish to change in the Color Select area. The color block will be highlighted in the work area.
- 2 Click to select the color, and the Color Selection dialog appears.
Note: On the Modify tab, click the white area to the right of a color block to select without opening the dialog.
- 3 Choose a thread range. The available shades for the thread range are shown in the list.
Note: The Abbreviation shows the reference used for the thread range when threads from that range are added to MyThreads.
Alternatively, enter a name in the manufacturer search box, then choose a thread range from the manufacturer popup list.
Note: To clear the manufacturer text box, click the Close  button in the box.
- 4 Click a color in the list to select a thread shade visually. Scroll to see more threads.
- 5 If you know the shade number, click in the number search box and enter the shade number.

Alternatively, enter some numbers in the number search box, and choose a thread from the thread number popup list. The current color is always shown.

- 6 To choose a color visually, click Colors  to select a color in the Colors window. See “Select a Color for a Thread” on page 83.

This is a quick way to jump to threads of the selected color (for example, click the light yellow pencil to jump to light yellow thread shades).

- 7 Click Manage to manage your thread ranges in mySewnet™ Thread Cache.
- 8 Click OK to confirm the color selection and close the color selection dialog.

Effects

Use the Effects area to show the results of using thread effects or special needles.



Puffy Foam Show the effect of stitching over embroidery foam



Dual Thread Show the effect of using two threads in one needle



Twin Needle Show the effect of using a twin needle





Wing Needle Show the effect of using a wing needle for hemstitch or heirloom designs







Felting Needle Show the effect of using a felting needle with a roving fiber



Cutwork Needle Select a cutwork needle in one of four angles

Note: Only one thread effect can be used on any thread. In the Modify tab of mySewnet™ Embroidery, most thread effects are not shown in the active subdesign, as it would be difficult to edit the stitches. They are shown in Design Player  and Life View , in addition to the other tabs.

To use Thread Effects

- Click the desired color block in the list, then choose an effect:
 - If you choose Puffy Foam , set the foam height.
 - If you choose Twin Needle , set the Twin Needle size. Click the color button for the Second Color if you wish to use a different thread color.
 - For Dual Thread , it is recommended to change the Second Color.
 - For Felting Needle , select a color for the roving fiber for felting.
 - For Cutwork Needle , choose the angle for your needles.

Puffy Foam

Use Puffy Foam  to show the three-dimensional effect of stitching over embroidery foam.

- Choose the height of the puffy foam in the pop-up menu from 2.0mm to 6.0mm.

Dual Thread

Use Dual Thread  to show the effects of stitching out two threads through the same needle. This is particularly suited to blending threads for special effects, such as mixing a rayon thread with a metallic thread, as in the center of the star.



Twin Needle

Use Twin Needle  to show the effect of stitching out the color block with a twin needle. This creates a horizontal offset between the original thread color in the left-hand needle, and a second thread color in the right-hand needle.

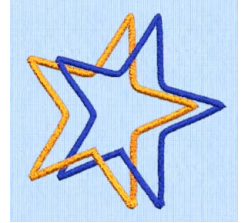

There are several ways that the Twin Needle effect can be used, including:

- Use with running stitch to create a ribbon effect, typically using the same thread color in both needles
- Use with a low density fill area to blend two different thread colors and also have a lightly shadowed effect
- Use with a dense fill area to create a shadow effect

Note: On the screen, the Twin Needle effect is shown horizontally from left to right. If you rotate an embroidery for stitching out, the twin needle stitchout will be different from the effect on screen.

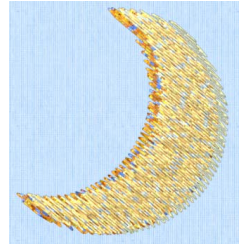

Size: Twin Needle Size is only available if the Twin Needle effect is selected for the current color block. Choose the size of the gap between the twin needles.

Preview the effect of changing the twin needle size to help decide which needles to buy. Ensure that the desired size is recommended for embroidery on your machine.

- Click the pop-up menu to choose the size of the gap between the twin needles.

Second Color: The second thread color for the twin needle is initially set to the same color as the original color block. Use Second Color  to choose a different thread for the second needle in the Color Selection dialog. The other color is displayed in the Twin Needle area.

- Click the color change button  to choose a different thread for the second color. Select the desired thread and click OK.

Wing Needle

Use Wing Needle  to show the effect of stitching out the color block with a wing needle and the chosen thread.

The wing needle creates holes in the fabric, for hemstitch and other heirloom techniques.

Note: To see the holes more than the stitch, use a fine thread such as Poly 60 weight. To see the actual stitching, Rayon 40 weight is ideal.



Felting Needle

Use Felting Needle  to show the effect of embellishing the selected color block using a felting needle and a contrasting roving fiber.

Choose a color for the roving fiber for the felting in the Color Selection dialog. In projects without a roving fiber, choose a felting needle color similar to the back of the fabric.

Note: If you select Felting Needle in mySewnet™ Digitizing the stitching will be adjusted. In other modules the effect is purely visual; for example, to see how felting will look in a pre-made design.

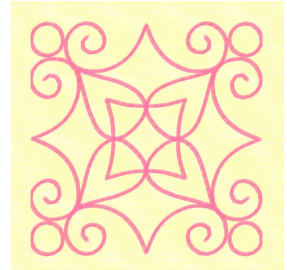

When Exporting an embroidery with a Felting Needle effect, the option "Flip design for felting or reverse embroidery" is initially selected in the Export dialog. See "Export" on page 33.

Cutwork Needle

Use Cutwork Needle  to show the line that would be used by cutwork needles to automatically cut holes in your fabric areas, or create appliqué areas. Use cutwork needle lines for reverse appliqué embroideries and free-standing lace, or simply to cut out a shape or design.

Choose the cutting angle for the cutwork needle.

(When creating cutwork needle lines in mySewnet™ Embroidery or mySewnet™ Digitizing, or converting running lines to cutwork needle lines in any mySewnet™ module, you may use two needles, or for more precise work use four needles.)

Colors Window

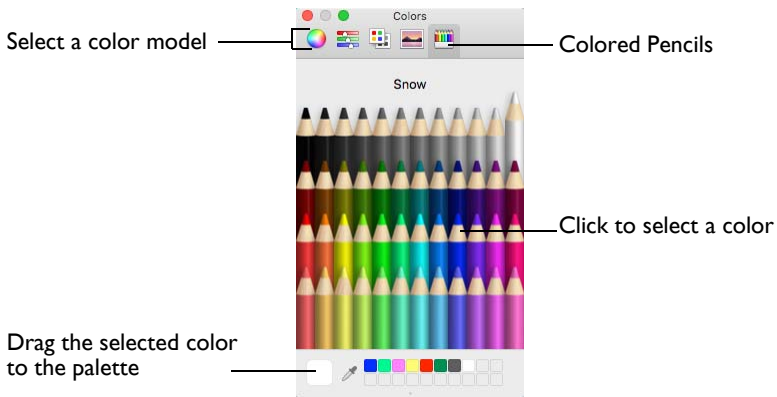

Use the Colors window to choose a color for a thread. The nearest shade in the current thread range is selected.



Use the Colored Pencils to select a color quickly.

Note: Other color models show a greater variety of shades: Color Wheel, Color Sliders, Color Palettes and Image Palettes.

Select a Color for a Thread

- 1 Select a thread in the Color Selection dialog.
- 2 Click Colors  to open the Colors window.
- 3 Click Colored Pencils  to select the Colored Pencils color model.
- 4 Click one of the 48 pencils. The thread color changes in the Color Selection dialog. The shade nearest to the pencil shade is used.
- 5 Click OK in the Color Selection dialog to confirm the color selection.

Color Tone

The Color Tone  page includes the Brightness, Contrast and Gamma sliders, and the Thread Range box.

Note: Try different settings to enhance different designs. You can combine more than one Color Tone tool.

In the Thread Range box, convert all the threads in an embroidery to a new thread range, with or without adjusting the Color Tone options.

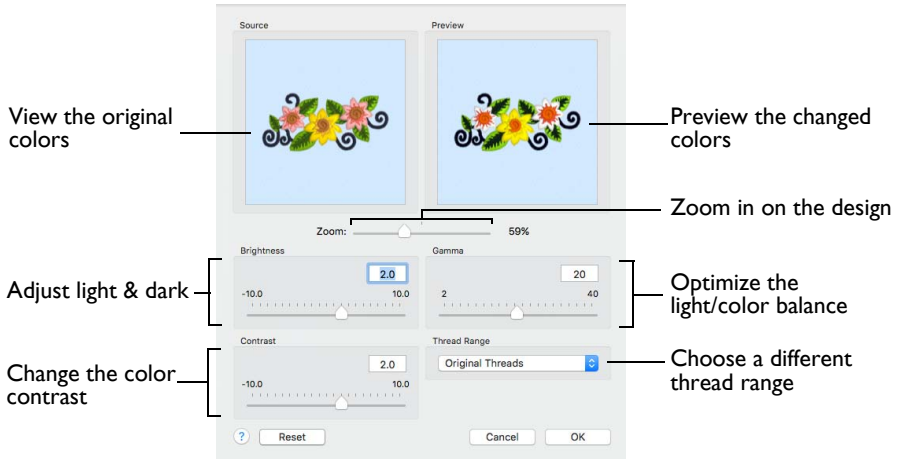

To use Color Tone

- Select the embroidery, then in the Design window click Color Tone .
- Select the embroidery, then choose Design > Color Tone.

Brightness

The Brightness effect makes the selected part or all of an embroidery lighter or darker than the original. Use it to lighten or darken embroideries.

- Drag the Brightness slider from -10 to +10. The default setting is 0.

Contrast

The Contrast effect changes the amount of shading between areas for the embroidery. Use it to make specific areas stand out. Adjust Contrast up to +10 or -10 more or less than the original. Increasing the setting will increase the darkness of dark areas and the lightness of light areas.

- Drag the Contrast slider from -10 to +10. The default setting is 0.

Gamma

Use Gamma to adjust the brightness and contrast together so that dark areas are made brighter, but bright areas are not overexposed. Lower values make the embroidery appear lighter.

- Drag the Gamma slider from 2 to 40. The default setting is 10.

Thread Range

Use the Thread Range box to select the thread range used for the embroidery from the pop-up menu. Choose from any of the manufacturer's thread ranges or one of the MyThreads ranges you create using mySewnet™ Thread Cache.



Note: If the embroidery originally used more than one thread range, only one thread range will now be used.

To return to the original thread range(s) used in the design select 'Original Threads' from the top of the list.

Reset

Reset the embroidery back to the original settings.

Use Color Tone to Change the Colors in a Floral Embroidery

- 1 Choose File > Insert.
- 2 Browse to mySewnet/Samples/Embroidery/Stitch.
- 3 Scroll down to load "Floral Motif.vp4".
- 4 Open the Design window  of the Control Panel .
- 5 Click the first thread in the color worksheet. The thread name and thread range is displayed in the Color Selection dialog. The Thread Range is Robison-Anton Rayon 40.
- 6 Click OK to close the dialog.
- 7 Click the Color Tone button  in the Design window. The Color Tone dialog appears.
- 8 Choose Robison-Anton Poly Neon 40 in the Thread Range pop-up menu. The colors are much brighter.
Note: The threads in the design are mapped to the nearest color in the range, and the result shown in the preview.
- 9 Choose Sulky Rayon 40 in the Thread Range pop-up menu. The change is more subtle.
Note: You can use Reset to reverse all changes made to the design.
- 10 Scroll up the Thread Range pop-up menu and choose Original Threads. The threads return to the original thread range(s) used in the design.
- 11 Drag the Brightness slider to the right to change the brightness to 2. The thread colors become paler.
Alternatively, enter a positive number in the box.
Note: To adjust the Brightness between -10 and +10 relative to the starting point, enter a number in the box, drag the slider, or click to one side of the slider. To darken the embroidery, drag the slider to the left, click to the left, or enter a negative number.
- 12 In the Contrast number box, enter 2.0 to change the contrast.
Note: To adjust the Contrast between -10 and +10 relative to the starting point, enter a number, drag the slider, or click to one side of the slider.
- 13 Click to the right of the Gamma slider to change the Gamma to 20.
Note: To adjust the Gamma between 2 and 40, enter a number, drag the slider, or click to one side of the slider.
- 14 Click OK to close the Color Tone dialog. The threads in the color worksheet change to their new color and range.

Zoom

Use the Zoom functions to change the view of the embroidery. Zoom in (drag the slider to the right) to magnify the view. Zoom out (drag the slider to the left) to shrink the view.

When zoomed in, use the scroll bars or swipe to move around.

ColorSort

Use ColorSort to reduce the selected embroidery to the minimum number of color blocks.

The final number of color blocks produced in the ColorSort process can vary, depending on any overlap between areas. If possible, it leaves only one color block for each thread color used. If necessary, trims are added to connect the areas that use the same thread color.

To ColorSort an Embroidery

- Select the embroidery, then choose Design > ColorSort.

Undo to return to the original colors.

Using ColorSort

ColorSort affects the structure of the embroidery:

- If characters in a piece of lettering have initially been placed as separate color blocks, it is recommended to ColorSort once the desired colors have been selected, and before combining text with existing embroideries.
- When you export an embroidery for stitching, it is ColorSorted unless you changed the default options.

This chapter describes how you can select, move and reshape embroideries, and how you can use Encore and Endless to place multiple embroideries in lines and shapes.

Selecting Embroideries

Select an Embroidery

In all windows except the Modify window, the currently selected embroidery is shown with a selection box around it. The selection box has square resize handles on the corners, triangular flip handles on the top and left, and a circular rotate handle on the right.

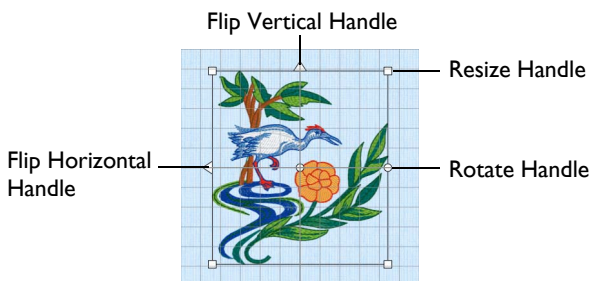

The handles are blue if in resize mode (density retained when resized), white in scale mode (stitch count retained when resized), and green for lettering, .edo designs, SuperDesigns and frames before they are fixed as embroideries, and in Encore.

Note: If a selection box has round handles on its corners, part of it is outside the selected hoop. Move it into the hoop, or change the hoop size.

If no design is selected, no selection box is visible and the Color Select area in the Design window is blank.

Note: Each of the selected embroideries may be rotated, mirrored or resized individually.

To Select an Embroidery

- Click the embroidery in the work area or FilmStrip.
- Press the Command and the left or right arrow keys to select each embroidery in turn.
- Choose Edit > Previous Design (⌘←).
- Choose Edit > Next Design (⌘→).

When making a selection, only embroideries that are completely enclosed by the selection line (Box, Point or Freehand Line) will be included.

Note: After embroideries have been combined, there is only one embroidery, so it will no longer be possible to select the individual parts in this way. Use Group to keep multiple embroideries, lettering and SuperDesigns together while retaining the ability to edit them individually. To select items within a group, use Restrict Group. Alternatively, use the Modify window to select and adjust the desired part of an embroidery. Individual stitches and blocks may always be adjusted in the Modify window. See “Select Stitches” on page 128.

The Context Menu and Individual Designs

Use the Context menu to access editing functions for individual designs, such as size and rotation.

You can also change the properties for stitch types in lettering (in addition to font characters, Lettering Shape and so on), frames and SuperDesigns, or fix them as stitches.

Adjust the appliqué fabric and margin for lettering, Frames and SuperDesigns, and decorations for an embroidery. See “Appliqué Selection” on page 195 and “Decoration Selection” on page 174.

Note: Use the context menu to adjust these properties if the Embellish tab is not available.

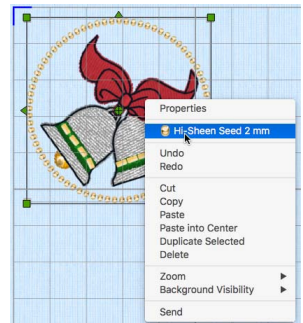

To adjust the properties for an individual design within a group, click Reveal Groups  below the FilmStrip or in the context menu, then select the desired item.

To access the context menu

- Control-click the design, and select the desired function from the context menu.

Multiple Select Features

You can select more than one embroidery at a time. Select embroideries individually on the work area, or use one of the selection tools on the Edit menu.

Note: When using Box Select, Freehand Select and Point Select the entire embroidery must be selected, otherwise it is not included in the selection.

To select more than one embroidery

- To select more than one embroidery, Command-click the desired embroideries.
- To select all embroideries in the work area, click Select All Visible .

The selected designs are surrounded by a selection box with a dotted outline, and orange handles. The faded outlines of the selection boxes for the included embroideries and other designs can be seen within the larger selection. Lettering,

frames, SuperDesigns and embellishment Gallery designs retain their green handles, and Monograms retain their light green handles.

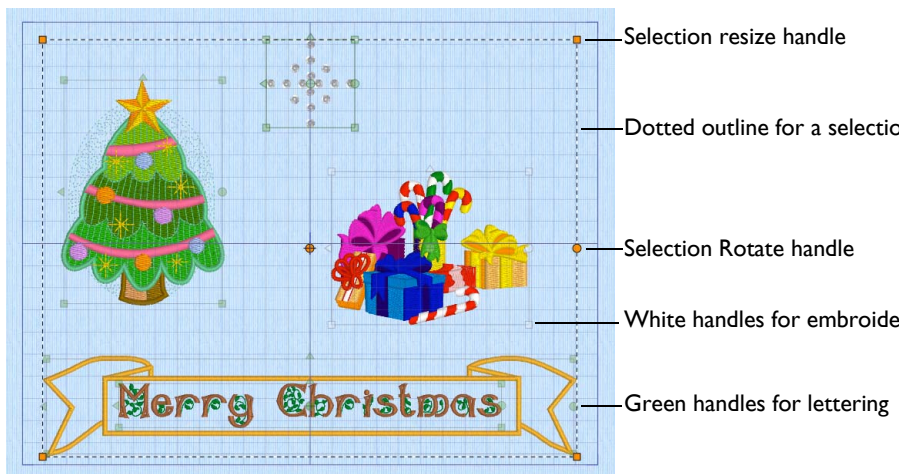

The whole selection can be moved, resized or scaled proportionally, or rotated. When a selection is enlarged or reduced, each item is resized or scaled according to its individual state.

- Lettering or SuperDesigns with green handles are resized with constant stitch density, as are embroideries with blue handles.
- Embroideries with white handles are scaled.

Note: There are no flip handles. To mirror the whole selection it must be combined.

The stitch count and thread colors for the complete selection can be seen in the Design Panel, and the width and height of the selection box are displayed.

If you click outside the selection box, the designs become separate. Select them again to recreate the multiple selection. To keep the selected embroideries together after saving, use Group. See “Group” on page 91.

Select All Visible

Select All Visible  will select all of the embroideries in the work area, including any that are outside the chosen hoop.

To Select All Visible

- Click the Select All Visible  button on the toolbar.
- Choose Edit > Select All Visible.
- Press ⌘A

Deselect All

Deselect All  will deselect every selected embroidery, including any that are outside the chosen hoop.

To Deselect All

- Click the Deselect All  button on the toolbar.
- Choose Edit > Deselect All.
- Press \uparrow ⌘ A

Box Select

Use Box Select  to select embroideries in a rectangular area.

Note: Use Add to Selection to increase the area of selected embroideries, or Remove From Selection to make the area smaller.

To select embroideries with Box Select

- Click the Box Select  button on the toolbar, then drag around the area you want to select.
- Choose Edit > Box Select, then drag around the area you want to select.

Freehand Select

Use Freehand Select  to select embroideries within an area of any shape.

Note: Use Add to Selection to increase the area of selected embroideries, or Remove From Selection to make the area smaller.

To select embroideries with Freehand Select

- Click the Freehand Select  button on the toolbar, then drag to draw an irregular outline around the desired embroideries.
- Choose Edit > Freehand Select, then drag to draw an irregular outline around the desired embroideries.

When you release the mouse the area is closed automatically.

Point Select

Use Point Select  to select embroideries within an area of any shape, defined by a series of points. Point Select may be easier to use than Freehand Select for precise selections.

Note: Use Add to Selection to increase the area of selected embroideries, or Remove From Selection to make the area smaller.

To select embroideries with Point Select

- Click the Point Select  button on the toolbar, then click a series of points to create an irregular outline of straight and curved lines around the desired embroideries. Control-click and in the Context menu choose Finish Point Select to finish.

- Choose Edit > Point Select, then click a series of points to create an irregular outline of straight and curved lines around the desired embroideries. Control-click and in the Context menu choose Finish Point Select to finish.

Replace Selection

Use Replace Selection  to replace the currently selected embroideries with the new selection.

To change the selection with Replace Selection

- Click Replace Selection  in the toolbar, and select several embroideries. Click one of the selection tools and select a few different embroideries. The new selection replaces the old one.

Add To Selection

Use Add to Selection  to add the new selection to the currently selected embroideries.

To change the selection with Add To Selection

- Click Add to Selection  in the toolbar, and select several embroideries. Click one of the selection tools and select a few different embroideries. The new selection is added the old one.

Remove From Selection

Use Remove from Selection  to remove the new selection from the currently selected embroideries.

To change the selection with Remove From Selection



- With several embroideries selected, in the toolbar click Remove from Selection . Click one of the selection tools and select embroideries within that selection. The embroideries you selected are removed from the selection.

Grouping Selected Embroideries

In mySewnet™ Embroidery, you can edit embroideries individually, in a selection, or in groups which remain together after saving.

Note: When a design including multiple subdesigns is loaded using Insert, all sections are grouped together, ready for moving, resizing and so on. If you use Open, it matches original groups exactly.

Group

Use Group  to make a more permanent group of all the currently selected designs. You can group designs permanently, or to make a temporary Group while moving or editing them. Each design in the group in turn is placed after the one that is earliest in the stitchout order (nearest the back of the project). Groups are shown in the FilmStrip, use Reveal Groups  to see the designs within a Group.

The grouped embroideries are surrounded by a selection box with a solid outline, and orange handles. The faded outlines of the selection boxes for the included embroideries and other designs can be seen within the larger selection. Text, .edo designs, frames, SuperDesigns and embellishment Gallery designs retain their green handles, while Monograms retain their light green handles.

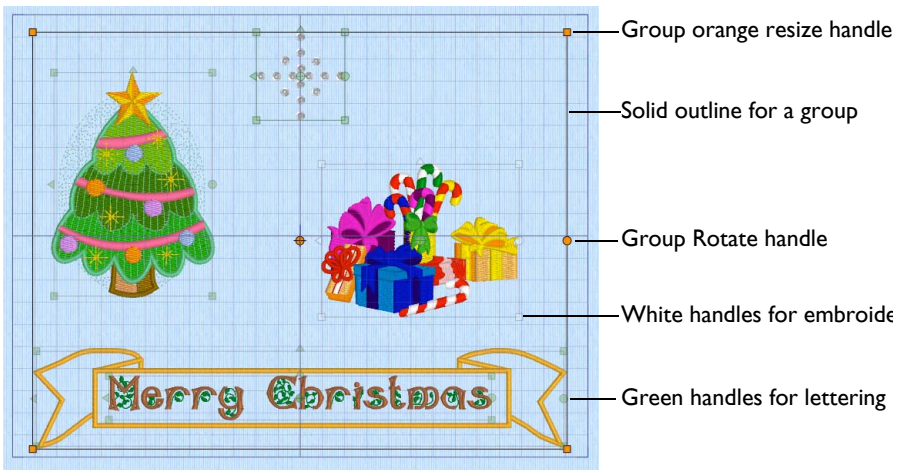

A group can be moved, resized or scaled proportionally or rotated. When a group is enlarged or reduced, each item is resized or scaled according to its individual state.

- Lettering or SuperDesigns with green handles are resized with constant stitch density, as are embroideries with blue handles.
- Embroideries with white handles are scaled.

Note: There are no flip handles. To mirror the whole group it must be combined.

The stitch count and thread colors for the complete selection can be seen in the Design Panel, and the width and height of the selection box are displayed.

If you click outside the selection box, and then click one of the designs within the group, the designs will still be grouped.

Create a Group of designs

- Place several designs in the work area, and select them with a selection tool. In the toolbar, click Group . The designs are grouped.

Ungroup

Use Ungroup  to split a selected group into the designs which make it up. These may be embroideries, or lettering, SuperDesigns, frames, Embellishment Gallery designs, and monograms.

Ungroup a Group of designs

- In the work area, select a Group of designs, and then in the toolbar click Ungroup . The designs are now separate.
- Select a group of designs, then Control-click the group and in the Context menu choose Ungroup.

Note: Ungroup can only be used when a group is selected.

Reveal Groups

Use Reveal Groups  to select and edit individual designs within a group. Reveal the contents of Groups in the FilmStrip, and temporarily disable all groups in the work area. The designs remain grouped, but they can be edited, moved, rotated, mirrored and resized or scaled independently.

Change a single design in a group with Reveal Groups

- Select a group of designs, and then at the bottom of the FilmStrip click Reveal Groups . Move or change any design within the group as desired.
- Select a group of designs, then Control-click the group and in the Context menu choose Reveal Groups. Move or change any design within the group as desired.



Christmas Greetings: Multiple Select and Group Designs

- 1 Click Hoop  in the toolbar, and in the Universal Hoop Group choose 260mm x 200mm - Universal Large Hoop 3, in Rotated orientation. Click OK.



- 2 Choose File > New to open a new window, then choose File > Insert.
- 3 In the folder mySewnet/Samples/Embroidery/Stitch load the embroidery 'Gifts & Candy Canes'.

Note: This is an embroidery; it has white handles showing that it is initially in Scale rather than Resize  mode.

- 4 Move the embroidery to the right side of the hoop.
- 5 Open the SuperDesign window  of the Control Panel  and choose "I - Christmas Tree" in the Holidays Category.

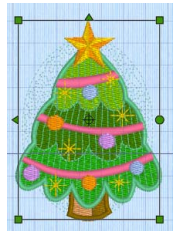

- 6 Set the Size of the SuperDesign to 90mm, then click Apply.
Note: The SuperDesign has green handles. For more about SuperDesigns, see "Creating SuperDesigns" on page 438.

- 7 Move the christmas tree SuperDesign to the left of the hoop, a little above the gifts embroidery.

- 8 Open the Letter window  and enter the words "Merry Christmas" in the Letters box.

- 9 In the Font pop-up menu choose the font Ivy 2C 15-60mm in the Floral Category. Ensure that the lettering Shape is horizontal block, and the Size is 15mm.

- 10 Click Apply and move the lettering towards the bottom of the screen, in the middle.

Note: The lettering has green handles. For more about lettering see "Creating Lettering" on page 355.



- 11 Open the Frame  window.

- 12 In Type, click the Frames  button, and choose banner 3 in the Banners 2 category.



- 13 Make sure that Group is selected (checked). This places the banner and lettering as a Group.
- 14 Ensure that the Merry Christmas lettering is selected, and click Apply. The banner is placed around the lettering.

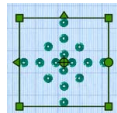

Note: The selection box around the banner has orange handles and a solid outline, as it is a Group. The lettering inside has a faded outline and pale green handles. For more about Frames, see “Frames, Borders & Underlines” on page 445.

- 15 In the Category section of the Embellish window , select Decoration , then click Insert from Gallery .
- 16 Browse to the folder DecorationDesigns/Miscellaneous, select the design Cross 2, and click OK to load it into the work area. The Decoration Gallery design Viewer closes.
- 17 Control-click the decoration design and select Pearl Sequin Cup 4.0 mm in the Context menu.
- 18 Click Color, and in the Colors window, set the sequin color to white, then click OK.
- 19 Move the Decoration Gallery design to the top center, to look like a star. It also has green handles.







- For more about Decoration Gallery designs, see “Decoration Gallery Designs” on page 171.
- 20 Press Command and the left or right key to see each design in turn. Each is in a selection box or group with a solid outline and orange, green or white handles.
 - 21 Use Box Select  or Select All Visible  in the toolbar to select all of the designs. The selection box for the selected designs has a dotted outline and orange handles.



Note: Ensure that the corner handles for the selection box are square. If not, move the designs so that all are within the hoop and try again.

- 22 Drag to move the selected designs as a unit, and use the round handle to rotate the selection.
- 23 Use Edit > Undo to reverse your changes.
- 24 Click outside the hoop. The designs are separate again.

- 25 In the ribbon bar, note that the Group  and Ungroup  buttons are not available (are dimmed).
- 26 Use Select All Visible  to select the designs again. The Group button is now available.
- 27 Click Group . The selection box for the group has a solid outline.



Note: The faded outlines and handles for the designs within the group can still be seen.

- 28 Click outside the group. None of the designs is selected.
- 29 Click the Christmas tree. The whole group is selected again, and the Ungroup  button is now available.

Note: Groups are permanent until they are broken apart with Ungroup. You cannot use Command and the left or right arrow to move between the designs within a group.

- 30 In the FilmStrip, click Reveal Groups . The Reveal Groups button is highlighted; and the last placed or adjusted design, here the decoration, is selected.

With Reveal Groups active you can select and edit the designs within the group individually, for example you could adjust the position of the Merry Christmas lettering within the banner, or change its properties.

Note: The lettering and banner are no longer grouped together, because there is only one level of grouping. A group cannot contain subgroups.

- 31 Click Reveal Groups  again. The group is now a single unit, and the Reveal Groups button is no longer highlighted.

- 32 Click Ungroup .

- 33 Drag to move the selected designs. They move as a unit.

Note: While the block is still selected you can reverse the effects of Ungroup by using either Group or Undo.

- 34 Click outside the selection box. The designs are now separate.

Note: Use Ungroup to make major changes to a group, or to use the designs within the group separately.

Move

Move the selected embroidery(ies), or selected block of stitches by dragging them.

When a block is moved in Modify mode, any stitches which lead to or from the block will be stretched to accommodate the new position.

Note: If you accidentally move the center of rotation, deselect and then reselect the design.

Moving an Embroidery

- Select an embroidery, and then move the pointer over the selection box. When the pointer changes to a four-headed arrow , drag the embroidery to the required position.



Nudge

An embroidery or block of stitches can be moved in small amounts to nudge it accurately into the desired position. Use the arrow keys on the keyboard to nudge an embroidery or block.

Note: When more than one embroidery is selected, all of them are moved.

You can also position embroideries automatically with Move into Hoop, Center in Hoop, and the alignment tools. See “Aligning Embroideries” on page 100.

Resize and Scale

Use Resize  to switch between resize and scale for the selected embroidery or block of stitches. Resize the selected embroidery to any size using free resize or rescale with the mouse. Alternatively, use Modify Design .

- Resize changes the size of the embroidery while retaining constant density.
- Scale changes the size of the embroidery while retaining constant stitch count.

The handles on the embroidery selection show when resize or scale is selected.



Blue handles for resize



White handles for scale







The resize and scale information for each subdesign is remembered separately.

Note: Lettering, SuperDesigns and Frames have green handles before they are fixed as embroidery. This allows them to be resized from their original design for optimum results.

To Switch between Resize and Rescale

- Click the Resize button  in the toolbar.
- Choose Edit > Resize Mode.
- Press ⌘R



Resize and Rescale an Embroidery

- 1 Open the Design window  of the Control Panel .
- 2 Choose File > Insert and select a small embroidery (for example, Toy Soldier.vp4 in mySewnet/Samples/Embroidery/Stitch).
- 3 Place the embroidery in the bottom left corner of the hoop.
- 4 With a selection box around the embroidery, click Resize . The handles change between blue and white as you click.
- 5 Click Resize  to make the handles white.
- 6 Look at the stitch count  in the Information section of the Design window.
- 7 Move the pointer over one of the square corner handles  and it becomes the diagonal double-arrow pointer .
- 8 Drag the handle at the top right until the embroidery is much larger.

Note: When using a trackpad, pinch two fingers on the selected embroidery to decrease the size, and spread two fingers to increase the size.

Gaps appear between the stitches. Although the size has increased, the stitch count has remained the same.

Note: Hold down Shift as you drag to resize or scale proportionally. Hold down the Option key to resize or scale from the center.

- 9 Click Actions  > Undo or ⌘Z to return the embroidery to its original size.
- 10 Select the embroidery again, and click Resize  until the handles are blue.
- 11 Drag the handle at the top right until the embroidery is several times larger. The stitching in the embroidery remains dense, as the stitch count has increased greatly.



Rotate

Rotate the selected embroidery or block of stitches to any degree using free rotation with the mouse. Alternatively, enter a specific angle with Modify Design  or rotate in 45 degree steps.

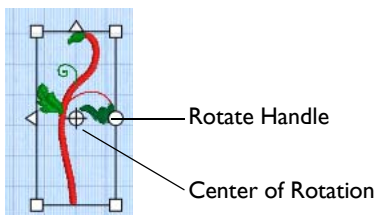
If desired, move the center of rotation before rotating the embroidery.



Rotate an Embroidery



- Select the embroidery and use the round rotation handle to rotate it freely. See “Using Free Rotation” on page 98.
- Select the embroidery, and in the Design window click Rotate 45  to rotate the embroidery by 45 degrees. See “Rotate 45” on page 98.
- When using a trackpad, twist your thumb and forefinger to rotate the selected embroidery, lettering or SuperDesign. Set Multi-Touch Gestures using Apple Menu > System Preferences.
- Select the embroidery, and in the Design window click Modify Design . In the Modify Design dialog rotate the embroidery, then click OK. See “Modify Design” on page 99.

Using Free Rotation

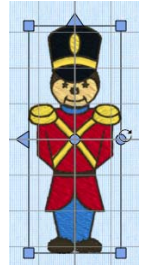
- 1 Select an embroidery.
- 2 Move the pointer over the round rotation handle and it changes to the rotate pointer.
- 3 Drag the rotation handle to rotate the embroidery freely to any angle. The embroidery and the selection box around it are rotated around the center of rotation.
- 4 Release the mouse button. The embroidery is now in its new position.
- 5 Undo to return to the original angle.



Move the Center of Rotation



The center of rotation  is initially shown in the middle of the embroidery or selection. Move the pointer over the center of rotation and it changes to the cross-hair pointer . Click on or within the center of rotation, then drag it to any position in the work area. This changes the pivot point around which the embroidery rotates for any of the rotation methods.

Note: Click outside the selection box and then select again to return the center of rotation to its initial position.

Rotate 45

Rotate 45 rotates the selected embroidery in 45 degree steps. To rotate an embroidery freely in the work area, see “Rotate” on page 97.

To Rotate an Embroidery by 45 Degrees

- Select the embroidery, then in the Design window  click Rotate 45 .
- Select the embroidery, then choose Design > Rotate 45. Undo to return to the previous angle.



Modify Design

Use Modify Design  to open a dialog where you can resize and rotate the selected embroidery.



Note: Whenever you resize or rotate, it is from the original embroidery settings.

To rotate a selected embroidery or block of stitches in the Modify window, see “Modify Block” on page 132.

To Open the Modify Design Dialog

- Select the embroidery, then in the Design window  click Modify Design .
- Select the embroidery, then choose Design > Modify Design.
- Select the embroidery, then click Actions  on the toolbar and choose Properties.
- Select the embroidery, then Control-click and choose Properties.

In the Modify Design dialog you can change the height and width of the embroidery, or rotate the embroidery. The changes are made when you click OK.

Click the lock button to adjust dimensions proportionally (lock closed ) or non-proportionally (lock open 

Size

Adjust height and width separately, or select Lock to change them proportionally. The size is given in millimeters, and as a percentage of the size when the dialog was opened.

Changing the Size

- Enter a number in the height or width number box.
- Use the arrows to increase or decrease the height or width.
- Select Lock to automatically resize height together with width.

Rotate

Rotate the embroidery to the desired angle.

Note: If desired, move the center of rotation  before rotating.

Rotating the Embroidery

- Enter a number in the rotation angle number box.

- Use the arrows to increase or decrease the angle of rotation.
- Drag the rotational slider to rotate the embroidery.

Flip Vertical and Horizontal

Mirror the selected embroidery or block of stitches vertically or horizontally using the flip handles on the selection box.

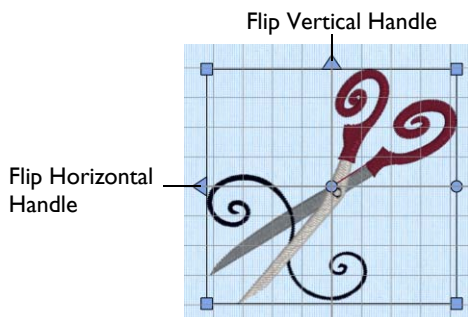

To Flip Horizontally

- Move the pointer over the Flip Horizontal handle and it becomes the horizontal double-arrow pointer. Click the Flip Horizontal handle to mirror the embroidery horizontally.

To Flip Vertically

- Move the pointer over the Flip Vertical handle and it becomes the vertical double-arrow pointer. Click the Flip Vertical handle to mirror the embroidery vertically.

Aligning Embroideries

Use the alignment features to position your embroideries in the work area.

Center In Hoop

Use Center In Hoop  to move the selected embroidery or group of embroideries to the center of the hoop.

To use Center In Hoop

- Select the embroidery to be centered, then in the Design window click Center In Hoop .
- Select the embroidery to be centered, then choose Design > Center In Hoop.

Move Into Hoop

Use Move Into Hoop to move the selected embroideries into the nearest area of the hoop.

Note: Only the selected embroideries that are outside the hoop are moved.

To use Move Into Hoop

- Select the embroideries to be moved into the hoop, or use Select All Visible, then choose Design > Move Into Hoop.

Alignment Tools

Use the Alignment tools on the Design menu to align embroideries precisely. Embroideries can be aligned horizontally or vertically. They can also be centered.

Note: The Alignment tools are only available when more than one embroidery is selected. See “Multiple Select Features” on page 88.

- Select the embroideries that you want to align, then use an alignment tool.

Horizontal Alignment

Align Left

Use Align Left to align all selected embroideries with the left edge of the design furthest to the left.

- Select the embroideries that you want to align, then choose Design > Horizontal Alignment > Align Left.

Align Center

Use Align Center (Center Horizontally) to center all selected embroideries horizontally relative to each other.

- Select the embroideries that you want to align, then choose Design > Horizontal Alignment > Align Center.

Align Right

Use Align Right to align all selected embroideries with the right edge of the design furthest to the right.

- Select the embroideries that you want to align, then choose Design > Horizontal Alignment > Align Right.

Distribute Horizontally

Use Distribute Horizontally to align all selected embroideries to be equally spaced horizontally.

- Select the embroideries that you want to align, then choose Design > Horizontal Alignment > Distribute Horizontally.

Vertical Alignment

Align Top

Use Align Top to align all selected embroideries with the top edge of the highest design.

- Select the embroideries that you want to align, then choose Design > Vertical Alignment > Align Top.

Align Middle

Use Align Middle (Center Vertically) to center all selected embroideries vertically relative to each other.

- Select the embroideries that you want to align, then choose Design > Vertical Alignment > Align Middle.

Align Bottom

Use Align Bottom to align all selected embroideries with the bottom edge of the lowest design.

- Select the embroideries that you want to align, then choose Design > Vertical Alignment > Align Bottom.

Distribute Vertically

Use Distribute Vertically to align all selected embroideries to be equally spaced vertically.

- Select the embroideries that you want to align, then choose Design > Vertical Alignment > Distribute Vertically.

Layout Order

Use the Stitch Order buttons below the FilmStrip (Stitch Later ▼, Stitch Earlier ▲, Stitch Last ▼ and Stitch First ▲) or the Layout Order commands on the Design menu to move embroideries within the design. Embroideries at the 'back' of the design are stitched out first.

Move Forwards

Use Move Forwards or Stitch Later ▼ to bring the selected embroidery one step closer to the front.

- Select the embroidery to be moved, then at the bottom of the FilmStrip click Stitch Later ▼
- Select the embroidery to be moved, then press ⌘F
- Select the embroidery to be moved, then choose Design > Layout Order > Move Forwards.

Move Backwards

Use Move Backwards to bring the selected embroidery one step closer to the back.

- Select the embroidery to be moved, then at the bottom of the FilmStrip click Stitch Earlier ▲
- Select the embroidery to be moved, then press ⌘B

- Select the embroidery to be moved, then choose Design > Layout Order > Move Backwards.

Move to Front

Use Move to Front to place the selected embroidery at the front.

- Select the embroidery to be moved, then at the bottom of the FilmStrip click Stitch Last 
- Select the embroidery to be moved, then press $\backslash \text{⌘} F$
- Select the embroidery to be moved, then choose Design > Layout Order > Move to Front.

Move to Back

Use Move to Back to place the selected embroidery at the back.

- Select the embroidery to be moved, then at the bottom of the FilmStrip click Stitch First 
- Select the embroidery to be moved, then press $\backslash \text{⌘} B$
- Select the embroidery to be moved, then choose Design > Layout Order > Move to Back.

Encore

Use Encore to place repeated copies of embroideries in a circle or ellipse, a line, a shape, or around the edge of the hoop.

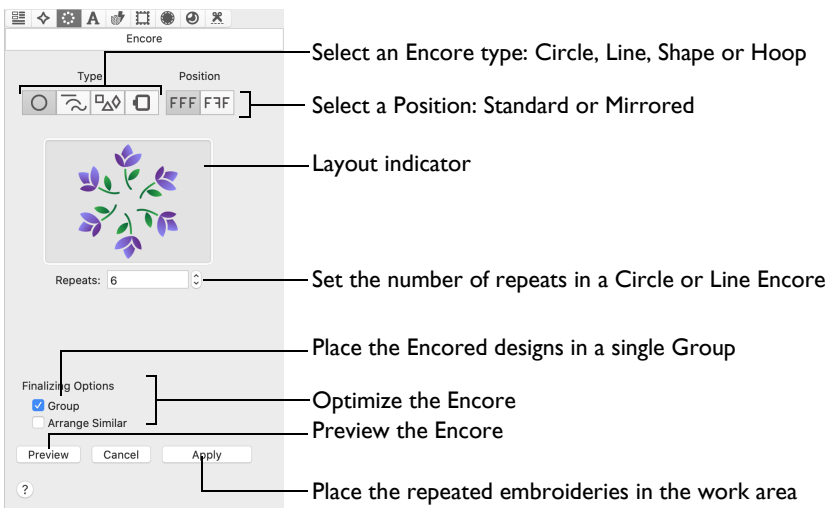

Choose the number of repeats, or the margin and gap, and the number of embroideries used. Set the position to standard or mirrored.







Any changes that you make to the settings will remain until you alter them, or close mySewnet™ Embroidery.

To Open the Encore Window

- Click Control Panel , then click Encore .

To learn how to	Go to
Use Encore to repeat an embroidery	See “Repeat an Embroidery with Encore” on page 104.
Create an Encore circle with a single design	See “Create a SuperDesign Daisy Chain” on page 444.
Create an Encore Line	See “Create a Line of Repeated Embroideries” on page 107.
Create a shape with Encore	See “Use Repeated Embroideries in a Shape” on page 109.
Use Encore in a Hoop	See “Use Repeated Embroideries in a Hoop” on page 110.
Use three designs in an Encore circle	See “Flowers in an Encore Circle” on page 106.

Repeat an Embroidery with Encore

- Place a small embroidery on the work area and select it.
- Open the Encore window  of the Control Panel .
- Select an Encore type (circle , line , shape  or hoop ) and Position (standard FFF or mirrored FF).
A preview image illustrates the combined effect.
- Set the number of Repeats, or the Margin and Gap.
- If desired, select Group and Arrange Similar.
- Click Preview to view the repeated designs in the work area.
Note: If you select any other tab on the control panel while in Preview mode, the Encore will be cancelled.
- Adjust the Encore line or shape on the work area, or adjust the settings and click Preview again.
- Click Apply to place the repeated designs as a grouped embroidery with the chosen options.

About Encore

Encore repeats the selected designs in a circle or ellipse, line, shape or hoop using the chosen position and number of repeats.

Note: You can use any number of embroideries with a line or circle, but only one or two embroideries with a shape or a hoop. To use more embroideries, Group or Combine them first.





With Line and Circle you can choose the number of Repeats. For Shape and Hoop the number of repeats is set by the size of the embroidery, the Gap and the Margin.

Note: Encore repeats designs in stitchout order, from back to front. In Shape and Hoop the embroidery that is first in the stitchout order is placed in the corners. Stitchout order can be changed in the FilmStrip or with the Layout Order commands.



Encore repeats an embroidery clockwise for Circle, Shape and Hoop, and from left to right for Line.

Note: If you combine multiple designs before using Encore, try to work from left to right. This will prevent trimmed threads from becoming caught under elements in the same color block.

Type

Circle		Place the embroideries in a circle.
Line		Place the embroideries in one of 8 line options from left to right.
Shape		Place up to two selected embroideries around the edge of a shape.
Hoop		Place up to two selected embroideries around the hoop edge.

Position

Standard		The copies of the embroidery use the original orientation.
Mirrored		Each alternate copy of the embroidery is reflected. This works best if the number of Repeats is an even number. <i>Note:</i> You cannot mirror grouped designs.

Circle

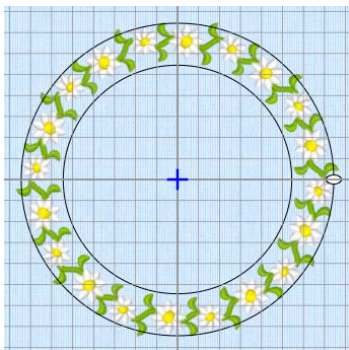

Place embroideries in a circle and set the number of repeats. Adjust the circle to form an ellipse.









Repeats: Set the total number of copies of the selected embroidery(ies) that will form the circle of repeated embroideries. Set the number of repeats from 2 to 360.

Note: If more than one embroidery is selected, the number of repeats of each embroidery is divided by the number of embroideries. So 10 repeats of 2 embroideries produces 5 of each embroidery.

To Adjust an Encore Circle

- Drag inside the circle using the four-headed arrow Move pointer  to position it.
- Drag one of the embroideries or the circle where they are placed, using the cross-hair pointer , to make the circle smaller or larger. See “Create a SuperDesign Daisy Chain” on page 444 and “Flowers in an Encore Circle” on page 106.
- Drag the white handle on the right to change the circle to an ellipse.

Flowers in an Encore Circle

- 1 If required, choose File > New.
- 2 Click Hoop  and in the Universal Hoop Group select Hoop Size 240mm x 150mm - Universal Large Hoop 2, Rotated Orientation, then click OK.
- 3 Open the SuperDesigns window  of the Control Panel .
- 4 In the Flowers and Leaves Category, Flowers 1 set, click the first flower in the top line, then click Apply. The flower is displayed in the work area.
- 5 Add the second and third flowers in the top line to the work area in the same way. (They are placed on top of one another.)
- 6 Click Select All Visible , or choose Edit > Select All Visible or $\text{⌘}A$ to select the three SuperDesigns.
- 7 Open the Encore window .
- 8 In Type, click Circle .
- 9 In Repeats enter 30.
- 10 Click Preview. Your three SuperDesigns are displayed in a repeating sequence in a circle, in the order you created them. There are 10 of each SuperDesign.
- 11 Click on the design at the top, and drag it downwards using the cross-hair pointer . The circle becomes smaller, and the designs move closer together.
- 12 Drag the elliptical handle on the right inwards. The circle changes to an ellipse.
Note: When adjusting in an ellipse, you cannot overlap the two sides of the ellipse. When adjusting in a circle, you can overlap at the center of the design.
- 13 Change the number of Repeats and preview again. If you change to Hoop or Shape and preview, you will notice that only the first two flowers that you created are in the Encore.
- 14 Click Apply to group the designs as a multipart embroidery.

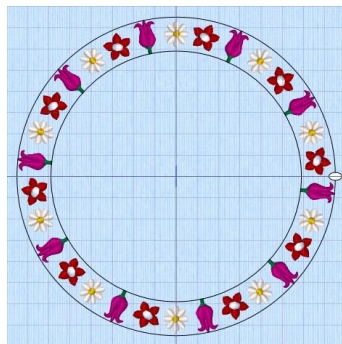

Line

Place the embroideries from left to right in one of 8 line types.

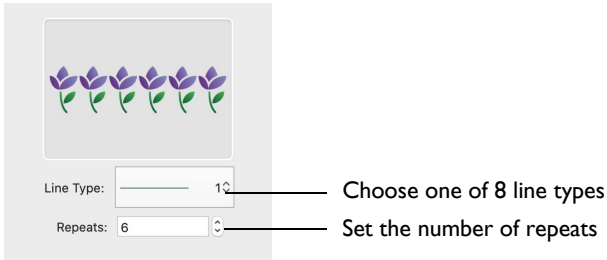

Line Type: Select a straight line, or one of seven types of curved line from the pop-up menu.

Repeats: Set the total number of copies of the selected embroidery(ies) that will form the line of repeated embroideries. Set the number of repeats from 2 to 360.

Note: If more than one embroidery is selected, the number of repeats of each embroidery is divided by the number of embroideries.

To Adjust an Encore Line

- Drag the line using the four-headed arrow Move pointer to position it.
- Drag the square handle on the top or right side of the line, using the double-headed horizontal or vertical pointer, to change the spacing between the designs.

Create a Line of Repeated Embroideries

- 1 Place some small embroideries on the work area and select them.
- 2 Open the Encore window of the Control Panel .
- 3 In Type, select Line . The Line options appear.
- 4 Select the Position (standard or mirrored .
- 5 Choose a Line Type from the pop-up menu.
The first option is a straight line. The other 7 line types are curved.
- 6 Set the number of Repeats as desired, from 2 to 360.
- 7 If desired, select Group and Arrange Similar.
- 8 Click Preview to view the repeated designs in the work area.
- 9 Drag the line of embroideries to position it.

- 10 Drag the square white handles on the top and right sides of the box to stretch or compress the box, and change the spacing.

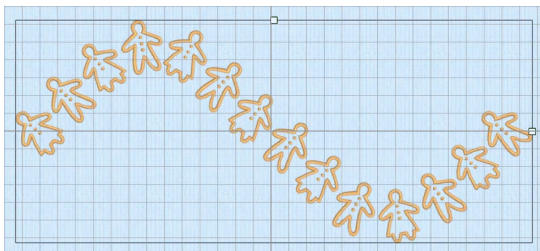

With a straight line, only the handle on the right is available.

- 11 Click Apply to place the repeated line as an embroidery.

Shape

Place up to two selected embroideries around the edge of a shape.

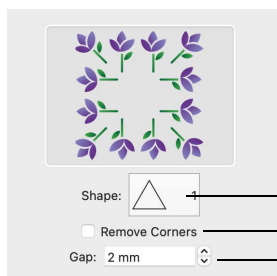

Shape: Choose from 50 different shapes

Remove Corners Use a corner embroidery at 45 degrees

Gap: 2 mm Set the gap between the embroideries

Shape: There are 50 shapes to choose from.

- Click the Shape button and choose a Shape from the pop-up menu.

Remove Corners: The embroidery is repeated along the sides of the shape, with one embroidery placed at 45 degrees in each corner of the shape. Select Remove Corners if you do not want this embroidery in the corners.

Note: If two embroideries are selected, the embroidery that is first in the stitchout order is placed in the corners. Use the FilmStrip or Layout Order to change the order. See “Layout Order” on page 102.

Gap: Set the minimum spacing between repeated embroideries.







Increasing Gap moves the embroideries further apart. Decreasing Gap moves the embroideries closer together. Negative Gap overlaps embroideries by up to 50%.

Note: The spacing will be increased if the Gap value would give a partial number of repeats on the sides of the shape. Thus, the spacing between the embroideries may differ, depending on the dimensions of the shape.

To Adjust an Encore Shape

- Drag the shape using the four-headed arrow Move pointer  to position it.
- Drag the square handle on the top or right side of the shape, using the double-headed horizontal or vertical pointer, to change the number of designs.
- Change the Gap between the individual embroideries.

Use Repeated Embroideries in a Shape

- 1 Place 2 small embroideries on the work area and select them (A).
- 2 Open the Encore window  of the Control Panel .
- 3 In Type, select Shape . The Shape options appear.
- 4 Select the Position (standard  or mirrored ).
- 5 Click the Shape button, and choose a Shape from the pop-up menu. There are 50 shapes to choose from.
- 6 Ensure that Remove Corners is not selected.
- 7 Set the Gap between the embroideries.
- 8 If desired, select Group and Arrange Similar.
- 9 Click Preview to view the repeated designs in the work area.
The embroidery that you loaded or created first is in the corners.
- 10 Drag the shape to position it.
- 11 Drag the square white handles on the top and right sides of the box to adjust the shape, and change the number and spacing of the embroideries.
- 12 Click Apply to place the shape as an embroidery.

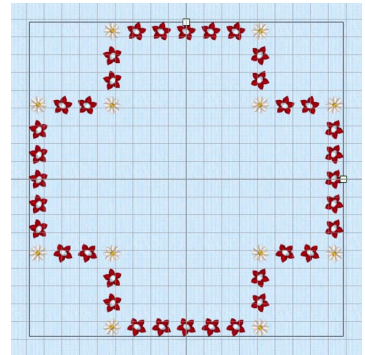

Hoop

Place up to two selected embroideries around the edge of the hoop, to make a border or frame.

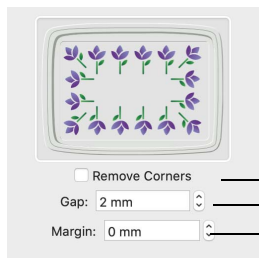

- Use a corner embroidery at 45 degrees
- Set the distance between the embroideries
- Set the space between the embroideries and the hoop

The maximum size limit for Encore Hoop is 2000mm.

Remove Corners: The embroidery is repeated along the sides of the hoop, with one embroidery placed at 45 degrees in each corner of the hoop. Select Remove Corners if you do not want this embroidery in the corners.

Note: If two embroideries are selected, the embroidery that is first in the stitchout order is placed in the corners. Use the FilmStrip or Layout Order to change the order.

Gap: Set the minimum spacing between repeated embroideries.

Increasing Gap moves the embroideries further apart. Decreasing Gap moves the embroideries closer together. Negative Gap overlaps embroideries by up to 50%.





Note: The spacing will be increased if the Gap value would give a partial number of repeats on either side of the hoop. Thus, the spacing between the embroideries may differ on the long and short sides of the hoop.

Margin: Set the space between the line of repeated embroideries and the edge of the hoop. The maximum Margin is half of the shortest hoop dimension.

To Adjust Encore in a Hoop

- Change the Gap between the individual embroideries.
- Change the Margin between the embroideries and the edge of the hoop.

Use Repeated Embroideries in a Hoop

- 1 Place 2 small embroideries on the work area and select them.
- 2 Open the Encore window  of the Control Panel .
- 3 In Type, select Hoop . The Hoop options appear.
- 4 Select the Position (standard  or mirrored .
- 5 Ensure that Remove Corners is not selected.
- 6 Set the Gap between the embroideries.
- 7 Set the Margin between the line of embroideries and the hoop.
- 8 If desired, select Group and Arrange Similar.
- 9 Click Preview. The Encore forms a frame around the inside edge of the hoop. The embroidery that you loaded first is in the corners.
- 10 Adjust the Margin and Gap as desired.
- 11 Click Apply to place the Encore as an embroidery.

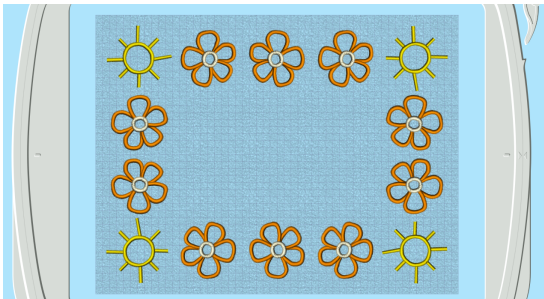

Arrangement

Group

Create a grouped embroidery from the Encored designs.

Note: If the designs are not grouped, they can be moved separately after they are placed with Apply.

Arrange Similar

Arrange individual designs together when using multiple embroideries that are overlapped, to optimize the results when ColorSort is used. This does not change the display order, only the stitchout order.

Preview

Preview the repeated embroideries in the work area.

Apply

Place the arrangement of designs on the work area as an embroidery with the selected Arrangement Options.

Once the repeated embroidery is created, you can change colors or use any of the other mySewnet™ Embroidery functions to adjust it.

Endless

Use Endless Embroidery  to add markers to an embroidery so it can be stitched out in a continuous, regularly spaced, sequence as many times as desired. After each stitchout, the fabric is re-hooped and the markers are used to align the new stitchout to the previous stitchout. Hence, the embroidery can be stitched out as a single, endless embroidery in a band.

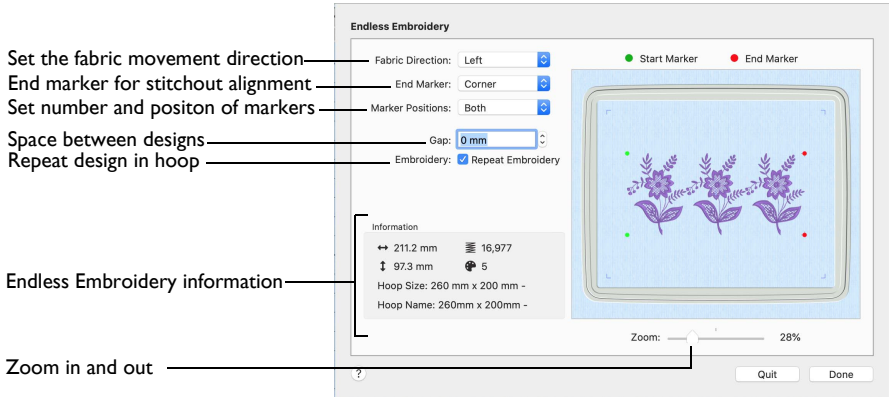



After changing settings, the effect is automatically updated in the preview area.

The Endless Embroidery settings are reset to their defaults when mySewnet™ Embroidery is closed.

Note: When embroideries inside the hoop are made Endless, any embroideries placed outside the hoop are removed.

Create an Endless design

- In the Design window  of the Control Panel  click Endless .
- Choose Design > Endless.

Fabric Direction

The Fabric Direction is the direction the fabric is moved in the hoop for each repeat. The direction depends on the size and orientation of the hoop as it is shown in the Preview area. Select from:

- Up
- Down
- Left
- Right

When the Fabric Direction is changed, the preview is updated. The Fabric Direction affects which sides of the embroidery will be the Start and End of the Endless Embroidery. The Start marker is always on the side of the embroidery that

matches the Fabric Direction. Hence, the Start Marker 'points' in the direction the fabric will be moved.

The default direction is Up for vertical hoops and Left for horizontal hoops.

End Marker

The end marker is used to line up the next stitchout of the embroidery. End marker positions are shown by red dots on the preview. Choose from four types:

Corner: A small L-shaped corner of three long loose stitches. The alignment point is the corner of the L. This is the default choice for the end marker.

Single Stitch: A long stitch that moves to the corners, placing only one needle point at each corner. This is ideal if you are stitching onto a fabric that you are concerned about marking, such as leather or a very light weight fabric.

Tie Off: A few stitches in the same place, centered on the alignment point. The Tie Off marker is very secure, but may be difficult to remove after stitching.

Line: A line of three long stitches. The alignment point is at the outside end of the line, closest to the edge of the hoop.

The Corner and Line markers are particularly helpful for checking that you have re-hooped your fabric straight enough for the next embroidery repeat, especially when both marker positions are stitched.

Note: There is no choice for start markers because they are always movement stitches. The start markers are used to move the needle into position so that it can be aligned with the end markers. Hence, only the single 'jump point' is needed for a start marker. The start marker positions are shown by green dots on the preview.

Marker Positions

Select the positions of the markers. "Both" is recommended for most situations. You may wish to have markers on only one side if:

- You have fabric that may be easily marked
- You have a fabric edge that can be easily followed each time you re-hoop the fabric
- You have an embroidery with a lot of open space on one side and you do not want to have any stitches in the open space, which may also partly conceal the presence of the marker stitches

Both: Select Both for movement stitches to both start corners and end markers on both end corners. This is the default choice for the marker position.

Left/Bottom: When the Fabric Direction is Up or Down, the markers are on the left edge. When the Fabric Direction is Left or Right, the markers are on the bottom edge.

Right/Top: When the Fabric Direction is Up or Down, the markers are on the right edge. When the Fabric Direction is Left or Right, the markers are on the top edge.

Gap

Use Gap to change the spacing between each stitchout of an embroidery. Gap changes the position of the start and end markers, as shown in the preview. The Gap is split evenly on each side of the stitchout.

Increase the Gap to move the embroideries further apart. Decrease the Gap to move the embroideries closer together. The Gap can be increased until the embroidery plus the Gap equals the full height or width of the selected hoop. Use negative Gap to overlap embroideries by up to 50%.

Set the Gap in steps of 0.1 mm. The default Gap is 0mm.

Embroidery

Repeat Embroidery

Repeat the embroidery as many times as possible within the current hoop size. This saves having to re-hoop the fabric for each stitchout of a small embroidery.

When Repeat Embroidery is selected, the preview will show how many times the embroidery can be repeated. The number of repeats is also affected by the Gap and the direction the fabric will be moved in the hoop.

Repeat Embroidery is selected by default.

Note: You may wish to save a single version of an endless embroidery as well as a repeated version. This will allow you to stitch out as many repeats as necessary. Use the repeated embroidery to stitch out the majority of the endless design, then use the single embroidery to stitch the remainder if the repeats do not give an exact fit. This works best if you move the single version of the embroidery to the center of the hoop before it is saved.

Remove Overlap

Use the Remove Overlap option to prevent areas of stitches building up when the repeated embroideries overlap.

Note: It is only recommended to deselect this option if, for example, you have a low density embroidery and you wish to have a blend effect where the repeats overlap or if the repeats only just overlap or have touching edges.

ColorSort

Use ColorSort to automatically ColorSort the embroidery when Repeat Embroidery is used.

ColorSort is only available when Repeat Embroidery is selected. This option is selected by default. The preview is not affected by the ColorSort option, although the Number of Colors in the Information area may change.

Preview

The preview shows how the embroidery will be made endless. The embroidery is shown in 3D, with the hoop shown as a blue outline. The current hoop size is shown in the Information area. The start and end marker positions are indicated by the green and red dots, respectively.





Note: To change the 3D background color or texture, use mySewnet™ Configure.

When Repeat Embroidery is selected, the maximum number of repeated copies of the embroidery that will fit will be shown in the preview. The number of embroideries will change according to the size of the original embroidery, the orientation of the hoop, the direction in which the embroidery is made endless and the Gap.

Note: The red dot showing the end marker position is not affected by the choice of end marker type.

Information

Preview

The Information area shows the current hoop size set for mySewnet™ Embroidery, and the stitch count , width , height  and number of color blocks  of the endless embroidery shown in the preview.

Zoom Bar

Use the Zoom bar to change the view of the embroidery. Zoom in (drag the slider to the right) to magnify the view. Zoom out (drag the slider to the left) to shrink the view.

When zoomed in, use the scroll bars or swipe to move around.

Done

Click Done to make the embroidery endless. The work area is updated automatically.

If Repeat Embroidery was selected and two or more repeated embroideries will fit, the repeated embroideries are connected with movement stitches and then ColorSorted. The endless embroidery is also centered in the hoop.

Note: If the embroideries are overlapped, they may not ColorSort to the smallest expected number of colors.

Start markers are inserted at the beginning of the embroidery as long movement stitches to the start marker positions. Movement stitches are added at the end of the embroidery to the end marker positions, which are then stitched according to the choice of end marker.

Note: To reload an Endless embroidery in the Endless Embroidery window, open it in mySewnet™ Embroidery and choose Endless . The Endless Embroidery

window is opened, and the alignment stitches are removed. Adjust it as desired, for example change the End Marker type, then close it again and save it.

Examples of Endless Embroidery Hoop Orientation and Fabric Direction

These pictures show how a heart-shaped embroidery (for example) could be repeated as an endless embroidery.

Vertical Hoop with Fabric Moving Up

A vertical hoop is chosen in Hoop Selection, then the Fabric Direction is Up in the Endless Embroidery dialog:

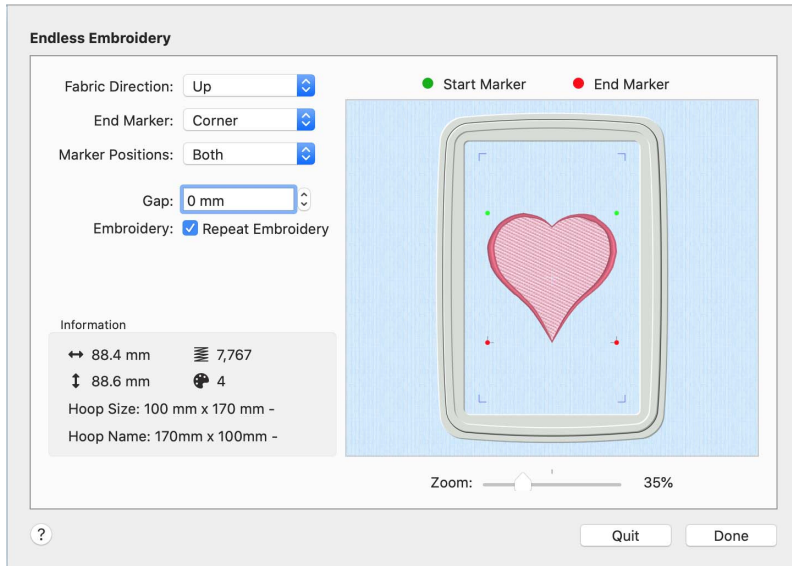

The fabric is hooped and moved in the machine like this:

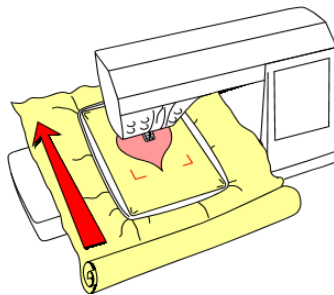

This results in a sequence of hearts, stitched in this order:

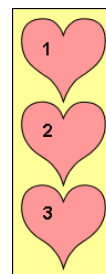

Horizontal Hoop with Fabric Moving Left

A horizontal hoop is chosen in Hoop Selection, then the Fabric Direction is Left in the Endless Embroidery dialog:

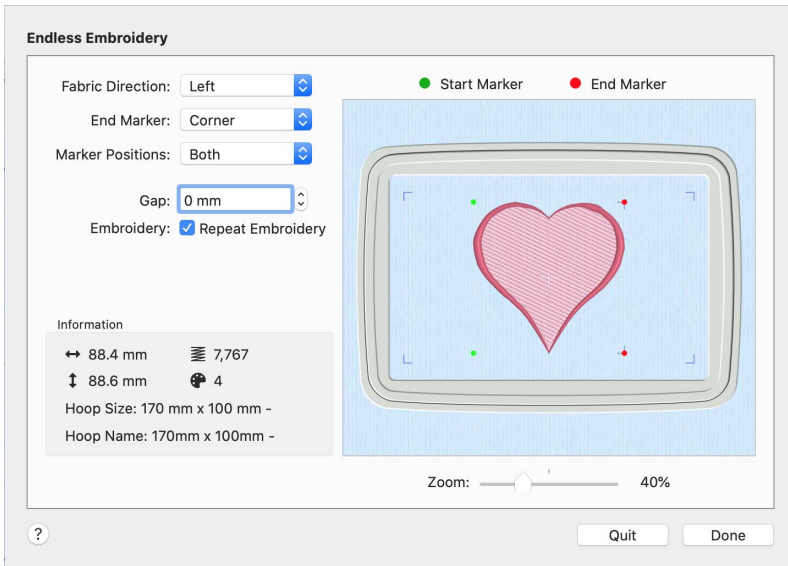

The fabric is hooped and moved in the machine like this:

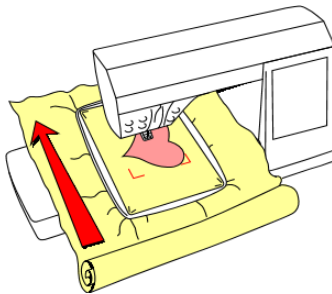

This results in a sequence of hearts, stitched in this order:

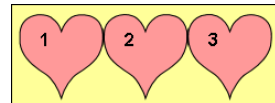

Stitch Out an Endless Embroidery

- 1 Load the endless embroidery.
- 2 Choose File > Print.
- 3 Click the Show Details button.
- 4 In the Design Scale pop-up menu, select 100%.
This is so you can print a worksheet of the endless embroidery at full size to use as a template.
- 5 Click Print and print a worksheet of the endless embroidery.

- 6 If the fabric does not have a straight cut edge you can follow, you may wish to mark a center line on the fabric. Make a crease, a chalk line or a line with light-reactive marker down the full length of the fabric where the endless embroidery will be stitched.
- 7 Load the endless embroidery on your embroidery machine and hoop up your fabric.
If you marked your fabric with a line, align the center marks on the edges of the hoop with the line.
Note: It is recommended to always make a test stitchout of your endless embroidery on a sample of the final fabric. Stitch out more than one copy to check that the spacing and marker type give the desired result.
- 8 Start by stitching out one copy of the embroidery. When the first copy stitches out, ignore the start marker movement stitches.
- 9 At the end of the stitchout, the end marker stitches will be stitched out last. Note where they are.
- 10 Re-hoop your fabric, moving it in the direction you chose in the Endless Embroidery dialog.
Note: If you had a horizontal hoop on screen and chose Left, lay your hoop in front of you horizontally as it would appear on screen and move the fabric to the left in the hoop.
Ensure that the stitches for the end markers (or single marker if you only used one) are inside the stitch area, to enable the alignment of the start marker for the next stitchout.
Note: If you have a hoop template that was supplied with the hoop, use this as a guide to positioning the end marker stitches inside the stitch area.
- 11 Use the printed worksheet to confirm that the next copy of the embroidery will fit in the stitch area when the start and end markers are aligned.
Note: This is particularly important if you are stitching an endless embroidery with a negative Gap, as you may need to bring the end marker stitches further into the hoop than seems obvious.
- 12 Tighten the hoop and ensure the existing embroidery is straight, so that the next copy will stitch in a straight line from it. If you marked a center line, this will help to ensure that the fabric is straight.
- 13 Load the hoop back into the embroidery machine and thread the first color.
- 14 Instead of starting straight away, use stitch navigation on the embroidery machine to step forward by one stitch to the start marker. Then use the needle position controls to align the needle exactly over the end marker.
Note: If the needle will not move far enough to align correctly with the end marker, the fabric was not hooped up with the end marker far enough inside the hoop. You will need to adjust your fabric in the hoop and try again.
- 15 If you chose to use Both markers on the endless embroidery, step forward by one more stitch to the second start marker to confirm it is over the second end marker.
Note: If the second marker is not aligned, then the fabric may not be straight in the hoop. If so, adjust it and try again. Alternatively, there may be pull on the fabric, in which case choose a compromise position that gives the best fit between the two markers.
- 16 After confirming the alignment is correct, start embroidering.
- 17 Repeat from step 8 until you have stitched out the desired number of copies.

Create an Endless Sewing Tools Border

1 Click Hoop  in the toolbar, and in the Universal Hoop Group set the Hoop Size to 240mm x 150mm - Universal Large Hoop 2, Rotated orientation. Click OK.

1 Open the SuperDesign window  of the Control Panel .

2 Select the Home Category from the pop-up menu.

3 Click to select the needle (2 - Needle), then click Apply to load it in the work area.

4 Select the Pin and Tape Measure SuperDesigns (numbers 3 and 6) and load them in the work area.

Note: Use the three designs at their default size.

5 Drag the three designs apart, with the Needle at the top, and the Pin and the Tape Measure below, as in the picture.

6 Select the Pin design, and click the  flip horizontal handle to make it face the other way.

7 Ensure that the Pin is between and to the right of the other designs.



8 Move the designs close together as in the picture. Use Select All Visible  to check the relative positions of the selection boxes around each design.

Note: The designs are positioned so as to show the features of the Endless Embroidery dialog.

While the relative positions of the designs are important, their position within the hoop is not. Designs are positioned in the middle of the hoop when they are made Endless.

9 Save the design as Sewing Tools.vp4.

Note: This will make it easier to recreate your Endless design later.

10 In the Design window  of the Control Panel  click Endless  to use the design in the Endless Embroidery dialog.

Note: All designs that are entirely within the hoop are used for the Endless design. Any designs that are partially or fully outside the hoop will be removed.

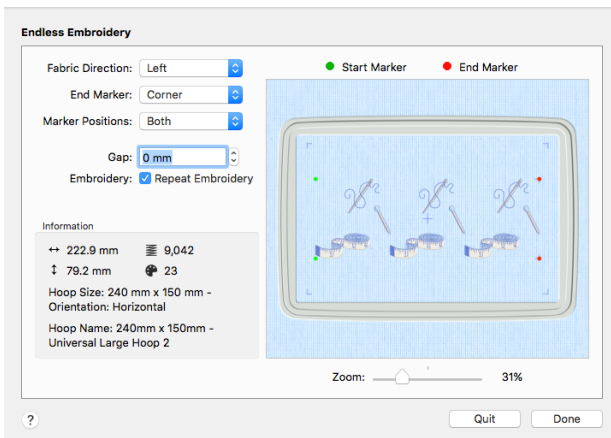
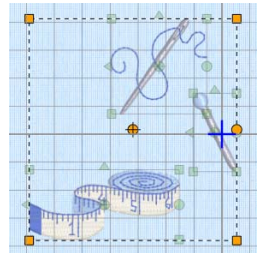
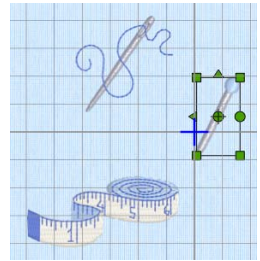





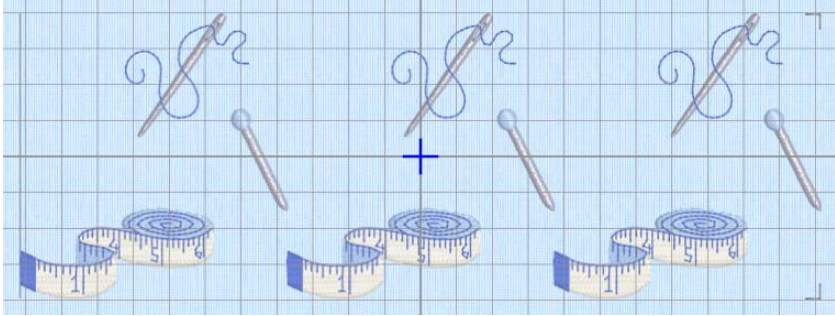

The hoop is in the Rotated position, and the green Start markers can be seen to the left. The design will be stitched from left to right. The red End Markers show where the End marker stitches will be placed after the rest of the design has been stitched.

Note: For a Natural hoop position, Up would be initially selected in Fabric Direction. This creates a vertical line of designs, rather than the horizontal border we are creating here.

- 11 Deselect (uncheck) Repeat Embroidery. Your three SuperDesigns form an individual Endless design.
- Note:* Use single designs of this type to add an extra design at the end of a series of Endless embroidery sections.
- 12 For this design we will use multiple design sets. Check Repeat Embroidery to view the three sets of designs again.
- 13 Click Done to view the Endless embroidery section in the work area.
- 14 Click outside the Grouped Endless design to see the gray stitched Start and End Markers.



Note: The straight line on the left is the Start Marker, and the corners at the right are the End Marker. The markers are immediately to the left and right of the Grouped designs.

- 15 In the Design window  of the Control Panel  click Endless  again to reload the design in the Endless Embroidery dialog.
- 16 The original Start and End Markers were removed, and new ones added when you reopened the design.
- 17 Deselect (uncheck) Repeat Embroidery. This time there are three sets of designs.
Note: When you reloaded the design the Start and End Markers were removed, however the design was saved as a single Group. To adjust the space between the sets of three SuperDesigns, we need to go back to the original set of three.
- 18 Click Quit to close the Endless dialog, then choose Edit > Undo to view your original three designs in the work area.
- 19 In the Design window  of the Control Panel  click Endless  again, and in the Endless dialog click to select (check) Repeat Embroidery to view the repeated designs.

- 20 Set Gap to -10.0 mm. The set of designs move closer together, and to the left and right they overlap the Start and End Markers.

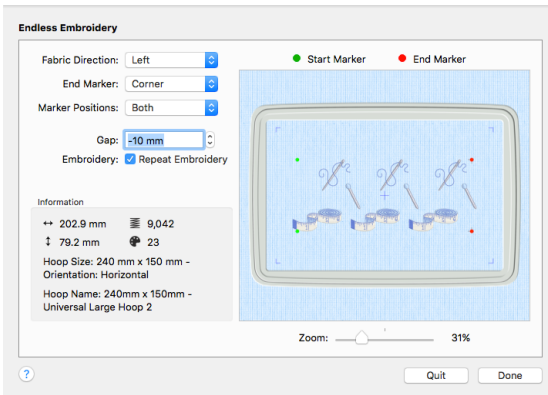

Note: Use a negative Gap to overlap the position of designs, or to create a continuous line of adjoining designs.

- 21 Click Done to view your Endless design again in the work area.

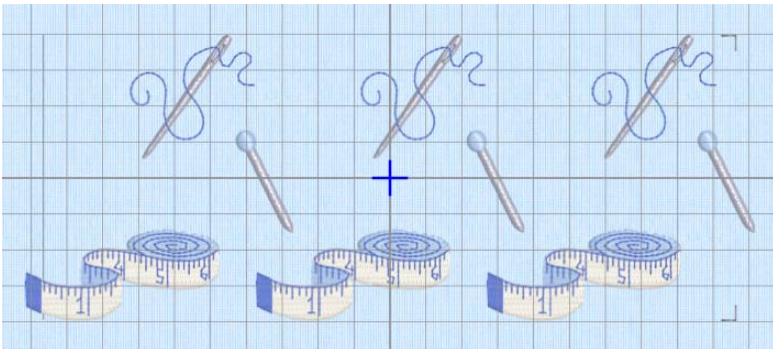

- 22 Save your design as Sewing Tools Endless.vp4, and then Export it in a format for your embroidery machine.

Note: To view how the Endless design will be used, Copy the design, then choose File > New and in this window set up a very large Custom Hoop (for example, 500 mm x 150 mm). Paste in two copies of your endless design. Place the Start Marker (the gray line) of the second design over the End Markers (the gray corner stitches) for the first design. This is how you will align your designs on your embroidery machine.

- 23 Choose File > Print and preview the worksheet for the Endless design.

Note: The settings that you used for your Endless design can be seen at the top of the Settings area, below the threads. You can use these to recreate the design later. Underneath are the settings for the SuperDesigns that you used.

- 24 In the print dialog, set the Design Scale to 100%, then click Print to print a worksheet for the embroidery.

Note: You can use this full size worksheet as a template.

- 25 Load the endless embroidery on your embroidery machine and hoop up your fabric.

Note: An Endless hoop makes life easier, but you can use any hoop with suitable dimensions.

- 26** Check the alignment of your fabric, then stitch out the first section of your endless embroidery.
Note: The end marker stitches are stitched out last. Note their position.
- 27** Re-hoop your fabric, with the end marker stitches for your first design towards the left of the hoop.
Note: Remember that the first part of the Tape Measure will overlap the Start Marker. Leave room for it when hooping up and aligning on your embroidery machine.
- 28** Use stitch navigation on your embroidery machine to step forward by one stitch to the start marker.
- 29** Use the needle position controls to align the needle exactly over the end marker.
Note: If the needle will not align correctly, check the position of the fabric in your hoop before trying again.
- 30** When the alignment is correct, embroider the second section.
- 31** Repeat for all of the other sections.
Note: For more details on stitching out, see “Stitch Out an Endless Embroidery” on page 117.

Cut, Copy, Paste and Duplicate Selected

Note: The functions to Cut, Copy, Paste and Duplicate a selected block of stitches are available only when using features in the Modify window.

Cut

Use Cut to remove an embroidery or the currently selected block of stitches from the design and place it in the Clipboard. It can then be pasted into the same or another project, or pasted into mySewnet™ Stitch Editor.

To Cut the selected embroidery or stitches

- Click Actions  on the toolbar and choose Cut.
- Choose Edit > Cut.
- Press ⌘X
- Control-click and choose Cut.

Copy

Use Copy to make a copy of an embroidery or the currently selected block of stitches. The copy is placed in the Clipboard. It can then be pasted as many times as required, including into mySewnet™ Stitch Editor.

To Copy the selected embroidery or stitches

- Click Actions  on the toolbar and choose Copy.
- Choose Edit > Copy.
- Press ⌘C
- Control-click and choose Copy.

Paste

Use Paste to paste the embroidery or block of stitches in the Clipboard into the work area, at the same place it was cut or copied from. The pasted embroidery is automatically selected, ready to be moved and manipulated as required.

To Paste an embroidery or stitches

- Click Actions  on the toolbar and choose Paste.
- Choose Edit > Paste.
- Press ⌘V
- Control-click and choose Paste.

Paste into Center

Use Paste into Center to paste the embroidery or block of stitches in the Clipboard into the center of the work area. The pasted embroidery is automatically selected, ready to be moved and manipulated as required.

Use Paste into Center

- Click Actions  on the toolbar and choose Paste into Center.
- Choose Edit > Paste into Center.
- Press ⌘⇧V
- Control-click and choose Paste into Center.

Duplicate Selected

Use Duplicate Selected to make a copy of the selected embroidery or block of stitches. The copy is automatically pasted on the work area below and to the right of the original.

To duplicate the selected embroidery or stitches

- Select the embroidery, then click Actions  on the toolbar and choose Duplicate Selected.
- Choose Edit > Duplicate Selected.
- Press ⌘D
- Control-click and choose Duplicate Selected.

Delete



Use Delete to remove one or more selected embroideries, pieces of lettering, SuperDesigns or blocks of stitches.

Note: Delete differs from Cut because it does not place the object on the Clipboard, so it cannot be pasted.

To delete a selected embroidery or block

Select the object(s), then:

- Click Actions  on the toolbar and choose Delete.

- Control-click the selected embroidery or block and choose Delete.
- Choose Edit > Delete.
- On full-size keyboards, press Delete .
- On Mac portable keyboards, press Function-Delete or Function-Backspace (fn ).

Undo and Redo

Undo reverses the last action. The undone action then becomes a Redo.

For instance, you might move an embroidery and then Undo the move. You could now Redo the move or do something else. If you delete the embroidery instead of using Redo then the Redo is lost, along with any other Redos that may have followed.

This is because Redo only works if nothing has happened after the last Undo. It is not possible to Redo the embroidery movement as something different has happened instead.



Undo

Use Undo to reverse the last action. If you are not satisfied with the result, click Redo.

There are unlimited Undo steps. Undo steps are only lost when you use New.

Note: Each time you use Undo the undone action becomes a Redo.

To use Undo



- Click Actions  on the toolbar and choose Undo.
- Choose Edit > Undo.
- Press Z
- Control-click and choose Undo.

Redo

Use Redo to reverse the last action that was undone by Undo. If you are not satisfied with the result, click Undo.

There are unlimited Redo steps. Redo steps are only lost when you use New.

To use Redo

- Click Actions  on the toolbar and choose Redo.
- Choose Edit > Redo.
- Press ⇧Z
- Control-click and choose Redo.

This chapter shows you how to select individual stitches or blocks of stitches for editing, how to move and reshape blocks, and how to add commands, stitches and ties.

Modify Window

In the Modify window you can select and change individual stitches and blocks of stitches in the selected embroidery, and add commands, stitches and ties.

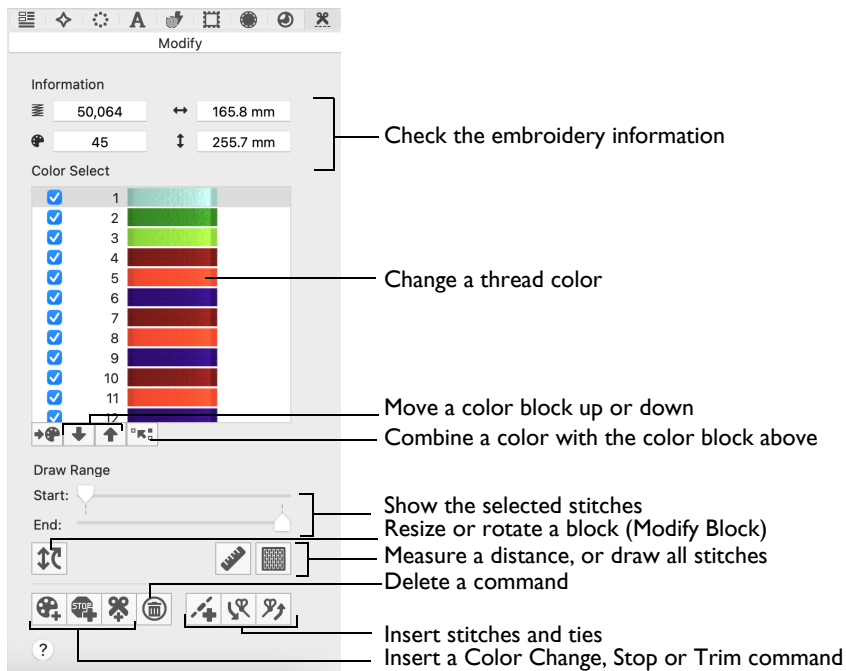

Select an embroidery, then open the Modify window to edit stitches and stitch blocks, to change, add and remove colors, to draw only the selected stitches, to add stitches and ties, and to add and remove Color Change, Stop and Trim commands.





Note: In the Modify window, embroideries are always shown as individual stitches in 2D mode. Zoom in close enough to see the separate stitches.

To Open the Modify Window

- Click Control Panel , then click Modify .

To learn how to	Go to
Select an embroidery for editing	See “Select an Embroidery to Modify” on page 126.
Select stitches within an embroidery	See “Select Stitches” on page 128.
Select a block of stitches	See “Select a Series of Stitches” on page 128.
Use Box Select	See “Box Select” on page 129.
Use Freehand Select	See “Freehand Select” on page 131.
Use Point Select	See “Point Select” on page 130.
Create a single block from selected stitches and blocks	See “Select All Visible” on page 131.
Measure distances on the work area	See “Get Length” on page 127.
Change the stitch order of the colors in an embroidery	See “Move and Merge Color Blocks” on page 133.
View the stitch order and select a range of stitches	See “View a Range of Stitches” on page 134.



Select an Embroidery to Modify

- 1 Open the Design window  of the Control Panel .
- 2 Select a small embroidery (for example, Bookend Teddy.vp4 in mySewnet/Samples/Embroidery/Stitch2/Toys) and place it in the bottom left corner of the hoop.
- 3 Load Bookend Doll.vp4 and Books.vp4 from this folder.
- 4 Open the Modify window  of the Control Panel .

The last embroidery that you selected is in full color. The other embroideries are shown as pale images in Automatic Ghost Mode.

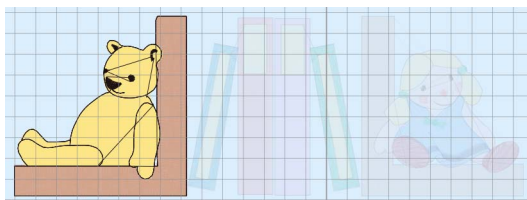
Note: Automatic Ghost Mode is used to show the position of the other parts of the design in the work area.



- 5 Return to the Design  window.
- 6 Click the teddy embroidery to select it, then open the Modify  window again. See “Selecting Embroideries” on page 87.

The teddy is now in full color, and the other embroideries are pale.

Note: The full color (editable) embroidery in the Modify window is the currently selected embroidery, or the first selected embroidery if several embroideries are selected, or the first loaded embroidery if no embroideries are selected. To select another embroidery, go to the Design window and press Command and the left or right arrow keys, or select the embroidery in the FilmStrip.

Viewing Embroideries in the Modify Window

Embroideries are shown in the Modify window in 2D View as individual stitches with no shading. The selected embroidery is shown in color. Any other embroideries use pale ghost stitches.

Automatic Ghost Mode

When the Modify window is selected to edit an embroidery, only the embroidery selected for editing is shown in color. All other embroideries are automatically shown as pale ghost stitches. This is so you

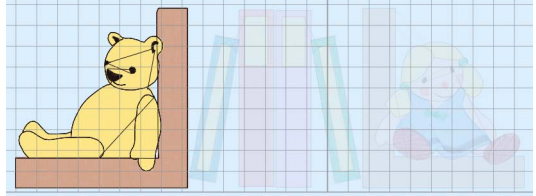

can still see the positions of other embroideries, so that you can observe where they are in relation to the embroidery you are editing.

Get Length

Use Get Length  to measure the distance between any two points on an embroidery.



For example, use it to obtain the width of a column of stitches or distance between lines of stitching.

Note: The length is shown in millimeters or inches, according to the setting for Show Measurements in mySewnet™ Configure. The alternative units are shown in parentheses.

To use Get Length

- In the Modify window of the Control Panel, click Get Length .

Measure a Design with Get Length

- 1 Open a design.
- 2 In the Modify window  of the Control Panel, click Get Length . The pointer changes to the measure pointer .
- 3 Drag across the part of the design you want to measure. A line shows the length you are measuring, and a tooltip displays the distance.
- 4 If desired, make a note of the number.
- 5 Drag to measure any other distances, as required.
- 6 Control-click, and choose "Finish Get Length" to deselect the function.

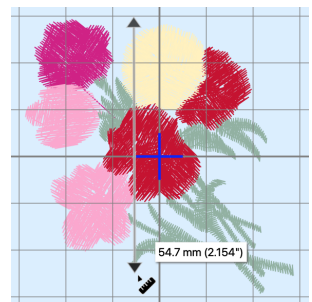

Select Stitches



Select Stitches  is used to select and edit single stitches.

Note: Select Stitches is only available when the Modify window is selected.

To select a stitch

- Click Select Stitches  in the toolbar (or choose Edit > Select Stitches), then click on a stitch to select it. Drag the box to move the stitch point. If desired, use Delete to delete the stitch point.

Select a Series of Stitches

- 1 With the Modify window of the Control Panel  selected, click Select Stitches  in the toolbar. The pointer changes to the stitch point pointer .
- 2 Click the first required stitch point. A box appears around the stitch point to show that it is selected.
- 3 To select several individual stitches, hold down Command and click the desired stitch points.
- 4 To select a sequence of stitches, hold down Shift and then click the first and last required stitch points. The two stitches you click and all stitches between them are selected.
- 5 Click outside the block to make a new selection using this method.

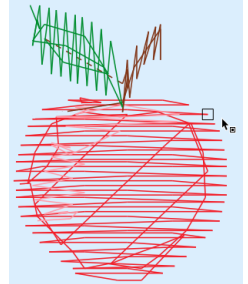

Select a Block of Stitches

In the Modify window, use the block Select functions to select part of an embroidery. A selected part of an embroidery is called a block. A block can be resized, rotated, mirrored, moved, nudged, duplicated, copied, cut and deleted.

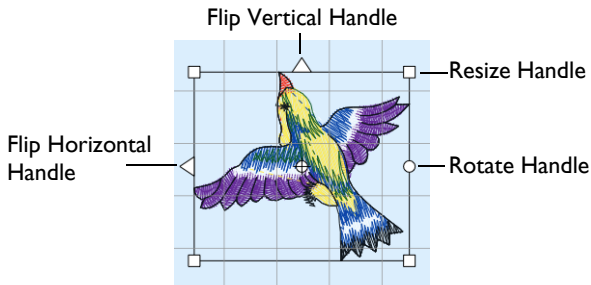

When a block has been selected, it has a selection box around it on the work area. The selection box has handles which are used to resize, rotate and flip the block.

Use Add to Selection to add an area to your selection, or Remove From Selection to remove an area from your selection.

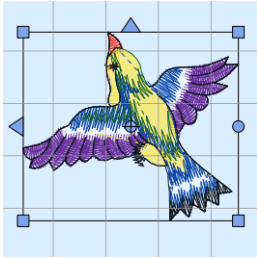

Blue handles for resize

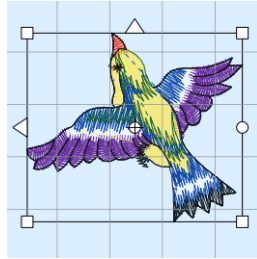

White handles for scale

Note: You may find it easier to select a block when you have selected colors to display and/or changed the ranges of stitches that are visible.

Move and Modify a Block

- 1 Drag inside the block to move it, or use the arrow keys on the keyboard to nudge it in small amounts for accurate positioning.
- 2 Drag the square corner handles to scale the block with constant stitch count (white handles) or resize with constant density (blue handles).
- 3 Drag the round rotate handle to rotate the block freely.

Note: Drag the center of rotation  to rotate around a different point.

- 4 Click the triangular handles to flip the block horizontally or vertically.

Note: You can also resize, scale and rotate a block precisely using the Modify Block  dialog. See “Modify Block” on page 132.

Pasting a Block

- When a block is pasted into an embroidery it is automatically selected as the current block, and Box Select is activated. The block is attached to the last visible stitch.

Deselecting a Block

- Click the work area outside a block to deselect it. The selection box around the block will disappear.

Box Select



With Box Select , drag to select stitches in a rectangular area.

Note: Use Add to Selection to add an area to your selection, or Remove From Selection to remove an area from your selection.

Select Box Select

- With the Modify window selected, click Box Select  in the toolbar. Drag to select the desired stitches.
- Choose Edit > Box Select. Drag to select the desired stitches.

Select an Area with Box Select

- 1 Click the Control Panel button  on the toolbar, then click Modify.
- 2 If desired, use the Draw Range sliders and color worksheet to hide objects so that it is easier to see the required stitches.
- 3 Click the Box Select button  in the toolbar and the pointer changes to the box select pointer .
- 4 Drag to draw a rectangle around the stitches you want to select.
- 5 Lift the pen or release the mouse button when the required stitches are enclosed. They become the current selection, as indicated by a rectangle with blue handles.
- 6 If you want to make a new selection, click outside the current selection to deselect it. Then draw a new box around the required stitches.

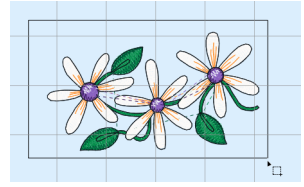

Note: Use Add to Selection to add an area to your selection, or Remove From Selection to remove an area from your selection.

Box Select is also activated automatically when a block is pasted into an embroidery.

Point Select



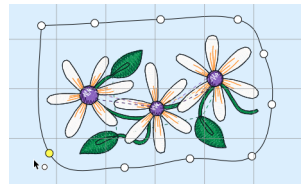

With Point Select , place points to select a block of stitches of any shape. Point Select may be easier to use than Freehand Select for precise selections.

Use Point Select

- With the Modify window selected, click Point Select  in the toolbar. Place points to draw an irregular outline around the stitches you want to select. Control-click and select Finish Point Select to finish.
- Choose Edit > Point Select. Place points to draw an irregular outline around the stitches you want to select. Control-click and select Finish Point Select to finish.



Select an Area with Point Select

- 1 Click the Control Panel button  on the toolbar, then click Modify.
- 2 If desired, use the Draw Range sliders and color worksheet to hide objects so that it is easier to see the required stitches.
- 3 Click the Point Select  button in the toolbar. The pointer changes to the Point Select pointer .
- 4 Click to place the first point, and the pointer changes to the point pointer .
- 5 Click to place a series of points for the border.

Note: As you click the fourth point on the line, the line becomes curved. The line may 'swing' while you place points. Just carry on, you can adjust it afterwards.

- 6 Use Shift-click to place square points for straight lines.
- 7 Move the pointer over one of the points on the line. The pointer changes to the Move Node pointer . Adjust the point as desired.

Note: When the Move Node pointer is active you can adjust existing points. If you click while the point pointer  is active, another point is added to the line.

- 8 When your line is as desired, double-click or press Return to surround the area with a selection box.
 - 9 If you want to make a new selection, complete the current selection and then place a new line around the required stitches.
- Note:* Use Add to Selection to add an area to your selection, or Remove From Selection to remove an area from your selection.
- 10 Control-click and select Finish Point Select to deselect the function.

Freehand Select



Use Freehand Select  to select a block of stitches within an area of any shape. Freehand Select is useful when an area cannot be easily selected by using the simpler Box Select function. It is particularly useful to highlight part of a color area which could not otherwise be easily selected.

Use Freehand Select

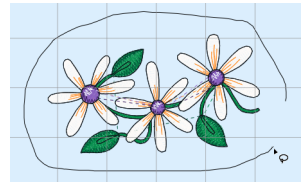
- With the Modify window selected, click Freehand Select  in the toolbar. Drag to draw an irregular outline around the stitches you want to select.
- Choose Edit > Freehand Select. Drag to draw an irregular outline around the stitches you want to select.



Select an Area with Freehand Select

- 1 Click the Control Panel button  on the toolbar, then click Modify.
 - 2 If desired, use the Draw Range sliders and color worksheet to hide objects so that it is easier to see the required stitches.
 - 3 Click the Freehand Select button  in the toolbar and the pointer changes to the freehand select pointer .
 - 4 Drag to draw an irregular outline around the stitches you want to select.
 - 5 Lift the pen or release the mouse button to select the stitches. The area is closed automatically with a straight line between the last mouse position and the start position. The block will show you the extent of your selection.
- Note:* Use Add to Selection to add an area to your selection, or Remove From Selection to remove an area from your selection.
- 6 If you want to make a new selection, click outside the current selection to deselect it. Then draw a new line around the required stitches.
 - 7 Control-click and select Finish Freehand Select to cancel the Freehand Select tool.

Select All Visible



Select All Visible  is a one-click function that selects all visible stitches in the current embroidery.

Use Select All Visible

- In the Modify window , click Select All Visible .

- Choose Edit > Select All Visible.
- Press ⌘A

Select an Area with Select All Visible

- 1 Click the Control Panel button  on the toolbar, then click Modify .
- 2 Use the color worksheet and the Draw Range to select which stitches are visible in the current embroidery.
This is useful to isolate an area of stitches, especially if it includes more than one color, or you only wish to select part of the area.
- 3 Click the Select All Visible  button. All visible stitches in the current embroidery are selected.

Note: The previously active select function, or Box Select, is selected after Select All Visible is used.

Deselect All

Deselect All  will deselect every selected stitch and block, including any that are outside the chosen hoop.

To Deselect All

- In the Modify window , click Deselect All .
- Choose Edit > Deselect All.
- Press ⌘A



Modify Block

Use Modify Block to open a dialog where you can resize and rotate the selected block.

To Open the Modify Block Dialog

- Select the block, then in the Modify window , click Modify Block .
- Select the block, then choose Design > Modify Design.

In the Modify Block dialog you can change the height and width of the block, or rotate the block. The changes are made when you click OK.

Click the lock button to adjust dimensions proportionally (lock closed ) or non-proportionally (lock open .

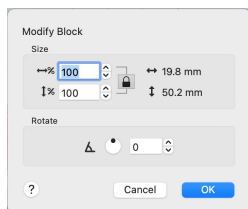

Size

Adjust height and width separately, or select Lock to change them proportionally. The size is given in millimeters, and as a percentage of the size when the dialog was opened.

Changing the Size

- Enter a number in the height or width number box.
- Use the arrows to increase or decrease the height or width.
- Select Lock to automatically resize height together with width.

Rotate

Rotate the block to the desired angle.

Rotating the Block

- Enter a number in the rotation angle number box.
- Use the arrows to increase or decrease the angle of rotation.
- Drag the rotational slider to rotate the block.

View Selected Colors

On the Modify window you can hide blocks of stitches according to their color. Displaying the stitches according to their color is an easy method of showing sections of an embroidery. The functions for viewing stitches by color are on the Modify window.

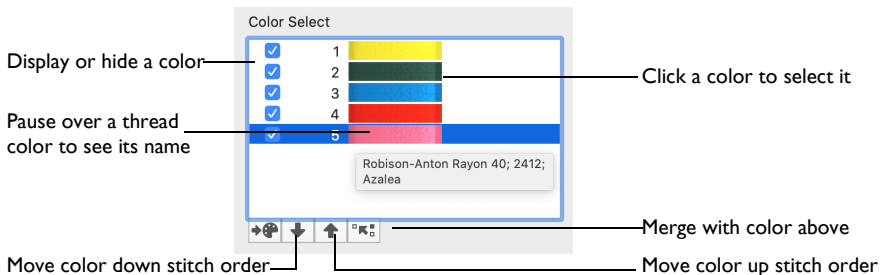

Hide stitches according to color, leaving the visible stitches available for other functions without affecting the hidden stitches. Selecting colors for display can be combined with the Draw Range to display a particular set of stitches that would be difficult to isolate with other functions.

Note: If you have set a Draw Range, then only the stitches in the color blocks that are visible within the range will be displayed. Also, hidden colors are not highlighted when the pointer is paused over them in the color worksheet.

Move and Merge Color Blocks



Use the arrows in the color worksheet to change the order of the color blocks, and to select color blocks to merge together selectively. For example, you can

keep two adjacent identical color blocks in case you wish to vary them later. If you use ColorSort, all identical colors will be merged unless there are overlapping stitches.

Note: This may be useful if you want to merge two blocks of an identical thread color without affecting the color order of the rest of the embroidery. Alternatively, use the Move and Merge Color Blocks features if ColorSort does not merge colors owing to a few overlapping stitches that do not affect the design stitchout. You can also use Merge when optimizing designs with multiple areas of cutwork and stabilizing lines. ColorSort may occasionally merge stabilizing lines in these circumstances.

To select and change colors, see “Color Select” on page 78.

Move and Merge Colors in the Worksheet

- 1 Select a color block in the worksheet to highlight it.
- 1 Click the up arrow  button below the worksheet to move the block up the stitching order.
- 2 Click the down arrow  button below the worksheet to move the block down the stitching order.
- 3 Click the merge  arrow button below the worksheet to combine the selected color block with the block above it, removing the Color Change command.

Note: Use Merge to delete color changes easily. Also use it to combine color blocks with the same thread color, after first moving one of the color blocks so that they are adjacent.

Effect of Draw Range on Color Blocks

If you deselect some of the check boxes in Color Select, and then change the Start or End stitch in the Draw Range, no stitches will be visible in the colors that you hid. To be seen, stitches must be visible in the Color Select and the Draw Range.

Display All

Display All  displays all stitches in the currently active embroidery. This is automatically used when a new embroidery is opened or mySewnet™ Embroidery is started.

When stitches have been hidden by changing the color selection or the Draw Range, click the button to view all stitches again. All the color blocks become visible and the Draw Range is reset to all stitches.

To draw all stitches

- Click the Display All  button in the Modify window.

View a Range of Stitches

The draw Start and End sliders in the Draw Range provide a very powerful way of viewing an embroidery and understanding exactly how it is formed. They allow you to progress forwards and/or backwards through an embroidery stitch by stitch and isolate a specific sequence of stitches. If desired, select the visible stitches as a

block to work on (Select All Visible ). Changing the range of stitches can be combined with selecting colors to display a particular set of stitches that would be difficult to isolate otherwise.

Draw Range (Sliders)

The upper slider sets the Draw From Start stitch. The lower slider sets the Draw To End stitch.

Use the Draw Range to set the Start or End stitch in either of the following ways:



Drag the slider

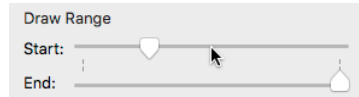





Click the space by the slider





- Drag the slider along the bar.
- Click in the space on the slider bar on either side of the slider to move it to the point where you click, or to the other slider if that is closer.

In both cases, the work area will show the range of stitches as the Start or End stitch changes.

Note: When you set a Draw Range, only the stitches in the color blocks that are visible within the range are displayed

Modify Stitches



When using the Stitch functions, click on the stitch that you want to modify. Add a color change, stop or trim command to your embroidery using Insert Color Change , Insert Stop , and Insert Trim . Remove commands with Delete Commands .

Color Change , Stop  and Trim  command markers can only be viewed when Delete Commands  is selected. They cannot be moved.



Note: To find a marker, click Delete Commands  so that the markers are shown, then Control-click and choose Finish Delete Commands.

Insert Color Change





Use Insert Color Change  to add a new color change at the point where you click. The stitches in the embroidery are displayed in the new color after the new color change and up to the next color change.

Note: When Delete Commands  is selected, a Color Change command  is shown by a blue circle with a C.

Select Insert Color Change



- In the Modify  window of the Control Panel , click Insert Color Change .
- Choose Edit > Modify > Insert Color Change.

Insert a Color Change

- 1 In the Modify  window of the Control Panel , click Insert Color Change . Alternatively, choose Edit > Modify > Insert Color Change.
- 2 Click on the stitch where you want the color change. The Color Selection dialog is displayed. See “Color Selection Dialog” on page 79.
- 3 Select the thread color for the new color change, then click OK to close the dialog.
- 4 Note that in the Modify window in the Control Panel  the new color block is placed in the worksheet sequence according to where you inserted the Color Change command.
- 5 Control-click and select Finish Insert Color Change to cancel the Insert Color Change tool.

Insert Stop

Use Insert Stop  to add a command which instructs the embroidery machine to stop at the point where you click, displaying a message.

Note: When Delete Commands  is selected, a Stop command  is shown by a red circle containing the letter S.





Use stop commands to transform an existing satin stitched 'outline' embroidery into an appliqué. Insert the stop commands so the appliqué fabric may be placed on the hoop, tacked down and trimmed. Stop commands may also be useful where a trimmed stitch might become trapped under the stitches that follow it.

Note: To view Stop commands with their messages, use the Design Player, or view them in the printed worksheet. To remove or edit the text of a Stop Command, use Undo and then Insert a new Stop, or use mySewnet™ Stitch Editor.

Use Insert Stop

- In the Modify  window of the Control Panel , click Insert Stop .
- Choose Edit > Modify > Insert Stop.

Insert a Stop Command

- 1 In the Modify  window of the Control Panel , click Insert Stop . Alternatively, choose Edit > Modify > Insert Stop. The pointer changes to the Insert Stop pointer .
- 2 Click on the stitch where you want to insert the stop command. The Stop dialog opens.
- 3 Use the Quick Text pop-up menu to insert a stitchout hint, or enter a message. See “Stop Properties” on page 137.
- 4 Click OK to place the Stop Command.
- 5 Control-click and select Finish Insert Stop to cancel the Insert Stop tool.

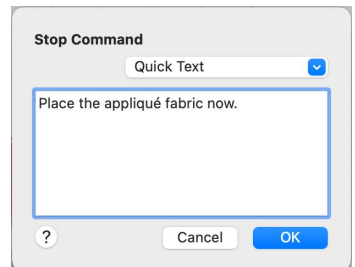

Stop Properties

Add a stitchout hint to a Stop Command in the Stop properties dialog.

Select a Quick Text comment from the pop-up menu, or enter text in the Comment text field. Click OK to save the text.

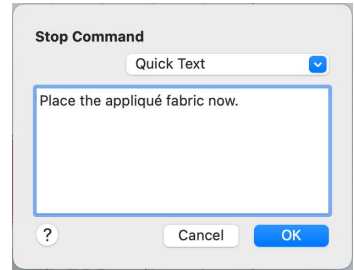



Quick Text

Select one of the following texts:

- Place the appliqué fabric now
- Cut around the appliqué
- Place the appliqué shape onto the placement line
- Cut the hole in your fabric
- Place the puffy foam on the fabric now
- Remove any excess puffy foam
- Check alignment now.

Insert Trim

Use Insert Trim  to add a command which instructs some embroidery machines to cut the thread.



Note: When Delete Commands  is selected, a Trim command  is shown by a green circle containing the letter T.

Use Trim commands when converting embroideries made for non-trimming machines for use on machines that support Trim commands. Trim commands can be added between areas of the same color. For instance, insert Trim commands to trim out the joining stitches between lettering when the thread color contrasts with the fabric.

Use Insert Trim

- In the Modify window of the Control Panel , click Insert Trim .
- Choose Edit > Modify > Insert Trim.

Insert a Trim



- 1 In the Modify window of the Control Panel , click Insert Trim . Alternatively, choose Edit > Modify > Insert Trim.
- 2 Click on the stitch where you want to insert the trim command. When a trim is inserted, the stitch disappears in 3D mode. While in 2D mode in the Modify window a dashed line indicates the movement or trimmed stitch.
- 3 Control-click and select Finish Insert Trim to cancel the Insert Trim tool.

Delete Commands

Use Delete Commands  to delete an unwanted Color Change, Stop or Trim command.

Note: You can also use Delete Commands  to find a marker. Click Delete Commands so that the markers are shown, then Control-click and choose Finish Delete Commands.

Use Delete Commands





- In the Modify  window of the Control Panel , click Delete Commands . Click on a Command marker to remove it. To cancel the function, Control-click and Choose Finish Delete Command.

Edit and Add Stitches

Editing Stitches

When editing stitches, zoom in close enough to see the separate stitches, so they are visible for selecting and moving.

Edit Individual Stitches

- 1 In the Modify  window of the Control Panel , click Select Stitches . The pointer changes to the stitch point pointer .
- 2 Click a stitch point. A box appears around the point to show that it is selected.
- 3 Drag the box to move the stitch point.
- 4 If desired, Control-click and choose Delete to remove the stitch point.
- 5 Control-click and select Finish Select Stitches to cancel the Select Stitches tool.

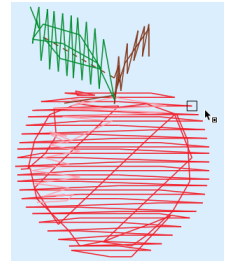



Insert Stitches

Use Insert Stitches  to add new stitches to an embroidery. For example, you may add more underlay to an embroidery or make a new section of an embroidery. You can even change an embroidery into an appliqué embroidery by adding placement stitches and Stops to secure the appliqué fabric.

Select Insert Stitches

- In the Modify  window of the Control Panel , click Insert Stitches .
- Choose Edit > Modify > Insert Stitches.

Using Insert Stitches

- 1 In the Modify  window of the Control Panel , click Insert Stitches . Alternatively, choose Edit > Modify > Insert Stitches.
- 2 Click the stitch where you want to add stitches.
- 3 Click again to place a new stitch point after the stitch point you started from.

Note: The stitches are added using the thread color where you insert the stitches. If you need to use a different color for the stitches, insert color changes before and after the new stitches have been added.

- 4 Each following click will place a new stitch point after the previous one.
- 5 Double-click or press Return to finish the line of inserted stitches.
- 6 Control-click and select Finish Insert Stitches to close the Insert Stitches tool.

Inserting Tie Stitches



Create a tie stitch automatically, to hold down the stitching at the point you click. Typically, tie stitches are used at the beginning and end of areas of satin or fill.

Note: You can add tie stitches to an embroidery where sections are coming loose after stitching out.

Insert Tie-On Stitch

Use Insert Tie-On Stitch  to add a tie stitch at the beginning of the stitch area to be secured. The stitches making up the tie stitch are inserted in the embroidery before the first stitch point of the selected stitch.

Select Insert Tie-On Stitch

- In the Modify  window of the Control Panel , click Insert Tie-On Stitch .
- Choose Edit > Modify > Insert Tie-On Stitch.





Insert Tie-Off Stitch

Use Insert Tie-Off Stitch  to add a tie stitch at the end of the stitch area to be secured. The stitches making up the tie stitch are inserted in the embroidery after the last stitch point of the selected stitch.

Select Insert Tie-Off Stitch

- In the Modify  window of the Control Panel , click Insert Tie-Off Stitch .
- Choose Edit > Modify > Insert Tie-Off Stitch.

Add Tie Stitches to Secure a Fill Area

- 1 Open an embroidery with a fill area.
- 2 In the Modify  window of the Control Panel , click Insert Tie-On Stitch . Alternatively, choose Edit > Modify > Insert Tie-On Stitch.
- 3 Find the beginning of the fill area to be secured.
- 4 Click the stitch where you wish to insert the tie stitch. A tie stitch is placed to secure the beginning of the fill area.
- 5 In the Modify window of the Control Panel , click Insert Tie-Off Stitch . Alternatively, choose Edit > Modify > Insert Tie-Off Stitch.

Note: There is no need to deselect the previous tool if another Modify tool is selected.

- 6 Find the end of the fill area to be secured.
- 7 Click the stitch where you wish to insert the tie stitch. A tie stitch is placed to secure the end of the fill area.
- 8 Control-click and choose Finish Insert Tie-Off Stitch to deselect.

Note: To delete a tie stitch, delete the stitch points making up the tie stitch.



Use **Split Project** to split a large embroidery project into sections for stitching out.

Split a large embroidery project into sections for stitching out.



Use the **Split Project Assistant**  to split very large projects, or to split smaller projects that are still too large to fit into your largest hoop. Select a hoop, then preview the embroidery, before splitting and saving or stitching it.

Note: Ribbon, Yarn and String of Beads lines cannot be split.

Split a project into sections

- In the Design window  of the Control Panel , click **Split Project** .
- Choose **Design > Split Project**.

Using the Split Project Assistant

- 1 Ensure you have an embroidery on the work area.
- 2 In the Design window  of the Control Panel , click **Split Project** .
- 3 In the Split Embroidery page click **Change Hoop** to select a hoop.
- 4 Select a Hoop Group, a Hoop Size, and the Orientation.
Note: To minimize the number of hoopings when stitching out, select the largest single-part hoop for your embroidery machine.

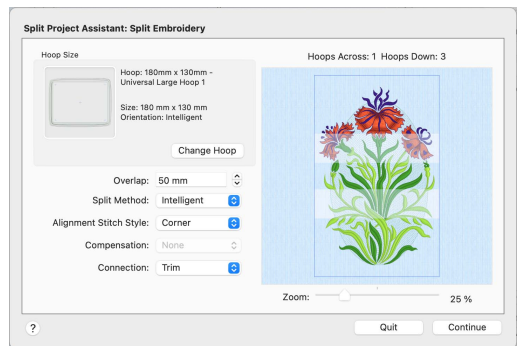

- 5 You can see the number of hoopings. If desired, increase or decrease **Overlap** to fit your embroideries within the hoop.
- 6 Click **Continue** to make a first split using these settings. If important features in the embroidery are split, click **Go Back** and adjust your settings.
 - For **Connection**, use **Running Stitch** and not **Trim** if you have to split large stitch areas.
 - Use **Corner** alignment stitches if lightly embroidered areas are split, and **Baste** if heavily embroidered areas are split. Some machines have special positioning features which do not require alignment stitches.

- 7 Click Continue. The Save Embroidery page appears.
- 8 Use the Previous ◀ and Next ▶ buttons to preview the splitting of the embroidery. Adjust the settings on the Split Embroidery page until satisfied.
- 9 Click the Export All Sections button to save the split embroidery. Browse to your My Designs folder, and name the project. The split sections will be numbered automatically.
- 10 Click Continue. The Print Options page appears.
- 11 Print a plan and worksheets for your project:
 - Overview prints a plan of the split sections, with section names.
 - Complete Template prints a full size template of the split embroidery sections, with an outline around each section to indicate how to join them together.
 - Worksheets prints a worksheet for each section. The worksheet gives the dimensions of the design, the total number of stitches, a full list of the threads used, and the number of stitches for each thread.
- 12 Click Done to close the assistant.

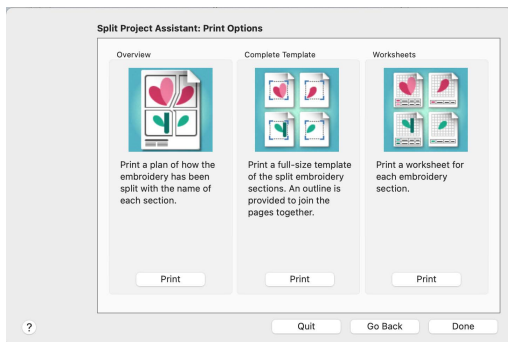
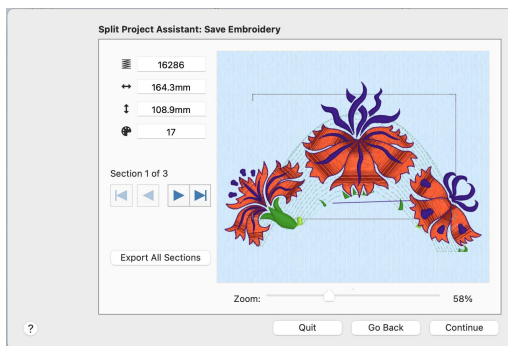

Split Embroidery

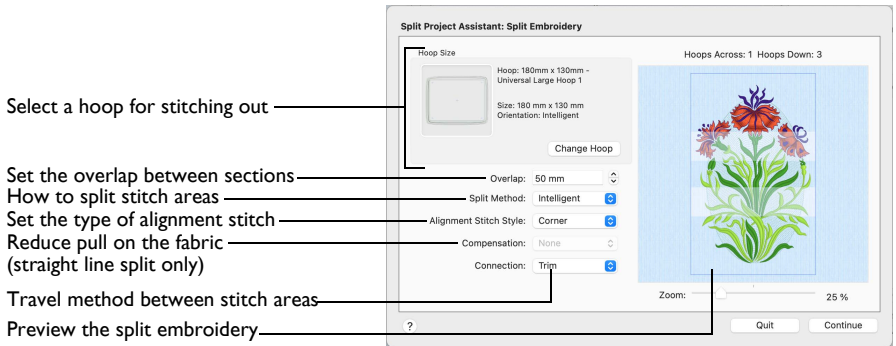

Use the Split Embroidery page to select the desired hoop size, the splitting method, the overlap between hoop areas, what type of alignment stitch to use, the level of compensation, and the type of connection for your project.

Experiment with the embroidery splitting options. This will give you the best possible split.

Note: Multipart hoops are not available for Split Project. Use the largest single-part hoop for your embroidery machine.

- Click Change Hoop and select a hoop for stitching out. Then select your other split settings, and click Continue.

Hoop Size

View the selected hoop, and its size and orientation. Set the hoop size according to the size of your project, or the hoop you wish to use for stitching out.

Note: The largest single-part hoop size for your machine is usually the best choice. This reduces the number of split sections, which reduces the number of split lines, hoopings, and color changes. The minimum recommended size is 100 x 100mm.

Change Hoop

Use Change Hoop to select a hoop for splitting the embroidery project in the Hoop Selection dialog. See “Hoop Selection” on page 22.

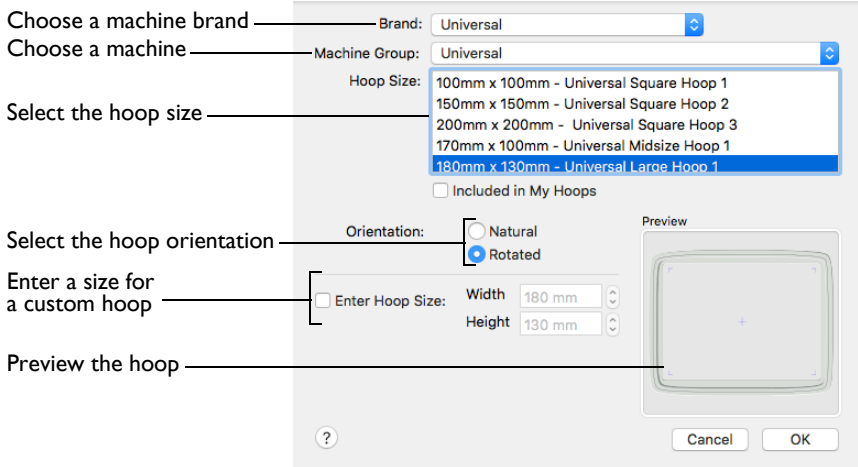

- Click Change Hoop and select a hoop, then click OK.

Overlap

Set the desired overlap between each hoop area. A large overlap is usually best, to provide maximum flexibility for adjusting the split lines. However, increasing the overlap may add unnecessary extra hoop sections, so check the previews carefully.

Hoops may not overlap more than 50%, so that adjacent horizontal and adjacent vertical split lines cannot cross each other. The minimum overlap is 9mm, and the maximum overlap is half the shortest side of the chosen hoop.

- Click the arrows to set the Overlap, or enter a value in the number box.

Split Method

To split automatically, use Intelligent or Straight Line split. Where possible, use Intelligent split, as it avoids cutting through solid sections of embroidery.

Intelligent: Intelligent split automatically calculates a split line that cuts the minimum number of stitches, and minimizes cuts through solid sections of embroidery. For example, a large embroidery will be split at a narrow section, and an embroidery that fits in one stitch area of the hoop will be left in one piece.

Straight Line: Straight Line split cuts through any individual embroidery that does not fit entirely into one stitch area of the hoop. Embroideries are cut straight across the center line of the overlap zone.

Note: Lettering may be split straight along the split line, cutting through characters rather than using gaps and spaces. In such cases, it is recommended to use

Intelligent split instead. For complex designs, use Split Project in mySewnet™ Stitch Editor.

- Choose a Split Method from the pop-up menu.

Alignment Stitch Style

Alignment stitches are used to help with lining up the split sections of the embroidery. Choose from None, Corner and Baste.

- Choose an Alignment Stitch Style from the pop-up menu.

None: No alignment stitches are added to the split sections. Select None when using a hoop template to align the split sections, or a fabric that you do not want marked by alignment stitches. None is also appropriate if you can split the embroidery project without cutting through any design elements.

Note: Some machines have special positioning features which do not require alignment stitches.

Corner: Trims are added at the beginning, and small L-shaped corners of three long loose stitches are added at the end of each split section. The alignment stitches go to the corners, halfway across the overlap between the hoop areas.

Use the trims at the beginning to align to previously stitched sections. The alignment points for subsequent sections are the corners of each L.

Use Corner for lightly stitched embroideries, and where there are only a few splits within design elements.

Baste: Trims are added at the beginning, and a box of long single stitches is added at the end of each split section. The alignment stitches go to the corners, half way across the overlap between the hoop areas.

Use the trims at the beginning to align to previously stitched sections. The alignment points for subsequent sections are the corners of the box of basting stitches.

Use Baste for heavily stitched embroideries that may be difficult to line up owing to pull on the fabric.

Compensation

Compensation adds overlapping stitches along the edges where the embroidery is split. This compensates for pull on the fabric. Choose None, Low or High. Compensation is initially set to None.

Note: Compensation is only available with Straight Line split.

- Choose a Compensation level from the pop-up menu.

None: Use None if you can split the embroidery without cutting through any of the design elements.

Low: Use Low when cutting through a lightly stitched embroidery, or when the split lines go through only a few stitch areas.

High: Use High when the embroidery is dense, when the split lines make long splits through stitch areas, or when stitching onto materials such as knitted or stretchy fabric.

Connection

Set how to connect separate areas of the same color along the edges of the split sections. The initial setting is Trim.

- Choose a Connection method from the pop-up menu.

Trim: Use movement stitches to travel along the edges of the split sections. This option is suitable when an embroidery project can be split without cutting through large stitch areas.

Running Stitch: Use Running Stitch when the split lines cross large stitch areas.

Continue



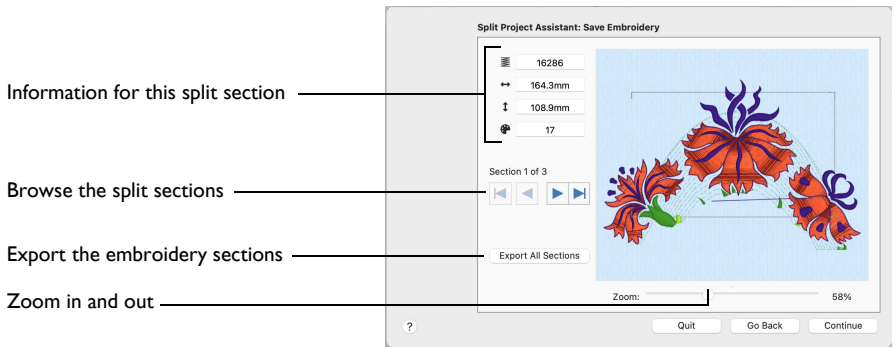

Go to the [Save Embroidery](#) page.

Save Embroidery







Use the Save Embroidery page to preview the split sections, and to export the split embroidery sections automatically.

Information

The information area on the left shows the stitch count , dimensions (height  and width ) and number of color changes  in the current section.

Section

To the left of the preview, view the number of the split section, and the total number of sections.

- Click the navigation buttons to browse through the split sections:
- Use Previous  and Next  to step through the split sections one at a time.
- Use First  to jump to the first split section.
- Use Last  to jump to the last split section.

Export All Sections

Use Export All Sections to export all the split embroidery project sections shown in the Save Embroidery preview as .vp4 files, or in an alternative embroidery format. The Split Project displays the Export dialog so you can select the embroidery format, then the Save or Save As dialog so you can name your design. For more information on using Export, see “Export” on page 33.

- Click the Export All Sections button use the Export dialog to export all the split embroidery project sections.

Export in any of the following embroidery file formats: Brother/Baby Lock/Bernina PEC (.pec), Brother/Baby Lock/Bernina PES (.pes version 2 - 11), Compucon/Singer PSW (.xxx), Husqvarna Viking / Pfaff (.vp4, .vp3 and .vip), Husqvarna (.hus, .shv), Janome (.jef and .sew), Melco (.exp), Pfaff (.pcs), Tajima (.dst) and Toyota (.10*).

Note: The preferred file format for saving embroideries is .vp4, as this will preserve the separate parts of multipart designs. It also preserves thread color information and notes.

File Name: When you save a split embroidery, you provide a single name which is used for all parts of the split embroidery.

Suffixes for Multi-Hoop Splits: For a multi-hoop split, the split parts are distinguished by a two digit suffix that is automatically added to the file name. The numbers start at 01 for the top left hoop, then increase across and down, for example Three Flowers_01 to Three Flowers_03.

Note: The numbers are used only to distinguish the individual sections. You can stitch out the sections in any order, as required.

Zoom

Use the Zoom bar to change the view of the embroidery. Zoom in (drag the slider to the right) to magnify the view. Zoom out (drag the slider to the left) to shrink the view.

When zoomed in, use the scroll bars or swipe to move around.

Go Back

Return to the Split Embroidery page.

Continue

Go to the Print Options page.

Print Options

Print a full-size template for each section

Print a plan of the split sections

Print a worksheet for each section

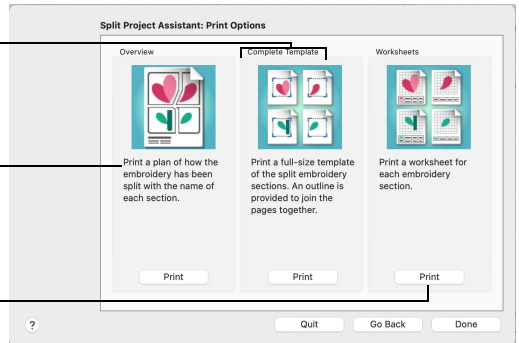

Use the Print Options page to print information on stitching and aligning your project. You can print worksheets, an overview, or a template.

Go Back

Return to the Save Embroidery page.

Done

Accept the final embroidery project layout and close Split Project.

Worksheets

Print a worksheet for each embroidery section. The worksheets illustrate the embroidery section, and list the threads to be used, and the quantity of each thread.

- Click the Print button to open the Print dialog, select print settings, and create a PDF or print the worksheets.

Note: Click the Show Details button in the Print dialog to select the information to be printed with the worksheet, and other settings. See “Print” on page 517.

Overview

Print a plan of the splitting of the embroidery, with the name of each section, and the number of stitches in each.

- Click the Print button to open the Print dialog, select print settings, and create a PDF or print the Overview.

Note: Click the Show Details button in the Print dialog to select the information to be printed with the Overview, and other settings. See “Print” on page 517.

Complete Template

Print a full size template of the split embroidery sections, with an outline around each section to indicate how to join them together.

See “Using the Template” on page 150.

- Click the Print button to open the Print dialog, select print settings, and create a PDF or print the template.

Note: Click the Show Details button in the Print dialog to select the information to be printed with the template, and other settings. See “Print” on page 517.

Stitch Out and Align Split Project Sections

Deciding the Stitchout Order

Generally, the split sections should be stitched out from the center. However, if the embroidery project only uses a few hoop areas, stitch out the section with the heaviest stitching first, as this will be the section which pulls the fabric the most.

As with all projects, it is best to try some test stitchouts before stitching the final version. It is particularly important to make test stitchouts of some adjacent sections if you think they may be difficult to align. For example, it may be difficult to align sections if the split line across a fully stitched area is very irregular, or when one of the sections has very heavy stitching.

General Alignment Considerations

Some designs will require less precise alignment than others. If you have split an embroidery so that the split lines go between all the stitch areas, for example if no connectors were used, it is unlikely that you will need to have perfect alignment between sections. The main consideration would be to ensure the fabric is straight each time it is re-hooped.

However, when any stitch areas are split, alignment is crucial to achieving a good stitchout. Using alignment stitches and compensation of Low or High will help to align sections and eliminate gaps between them.

There are also various alignment aids including:

- The printed full size template
- Worksheets for each section, optionally printed on transparency paper
- The hoop template supplied with the hoop for your machine
- Light sensitive pens that can be used to mark fabric, and other temporary fabric marks
- Fabric stiffening aids and stabilizers that combat pull and make alignment easier
- The needle and embroidery positioning controls on your embroidery machine

Using the Template

This is the most useful alignment aid. The template shows the whole embroidery at the size it will be stitched out. Each hoop area is marked by corners and a large + in the center.

The hoop area corners show the extreme points of the stitchable area within the hoop. If you have a hoop template supplied with your hoop, this corresponds to the stitchable area shown on the hoop template, usually marked as a grid.

The template starts in the top left corner and works across and down to the bottom right corner. When cutting out and joining the pages together, you may find it easier to leave the first page uncut, then cut the dashed edge of the next page before aligning it to the first page and taping it in place. Continue like this until all the pages are joined together.

Note: You can also use the template as a guide to the size of your piece of fabric. The template shows the overall stitchable area that will be hooped, but you will need to allow extra fabric around the edges for physically hooping up the fabric.

Use the template to mark hoop centers on the fabric. Use a pin to punch a hole through the template at each hoop center. Pin the template to the fabric and mark the fabric through each hole. If the point that is marked will be stitched over and hidden, use a pencil or a pen to mark the center point. If the point will be on open fabric, use a light-reactive fading pen.

Using Other Alignment Aids

Fabric Choice, Stiffeners and Stabilizers

In general, stiffer fabrics will resist pull and distortion better.

Fabric stiffening aids and stabilizers will combat pull and make alignment easier. In particular, iron-on backing helps to resist fabric distortion. You may wish to apply this to the fabric before marking the hoop centers or making any other alignment marks.

Hoop Templates and Printed Worksheets

When hooping up each section, align the center marked on the fabric against the hoop template to guide the position of the fabric in the hoop. If you do not have a hoop template, use the printed worksheet at 100% scale for the section. You could also print the worksheet on transparency paper.

Center Lines

You may also wish to mark lines between the hoop center points so you can line up the fabric to the center marks on the frame of the hoop. This is especially helpful if you do not have a hoop template. Use a light-reactive fading pen to mark temporary lines just before you hoop the fabric. An alternative is to iron creases into the fabric as lines between the center points.

Stitching Out the First Section

First, ensure the fabric is straight in the hoop, according to the marked positions of the hoop centers. After selecting the embroidery on the machine, use the machine controls to position the needle over the center point marked on the fabric.

Note: If you are unable to do this on the machine, this means that you have not hooped up your fabric with sufficient accuracy. You will need to move the fabric in the hoop and try again.

If you did not generate alignment stitches, simply start stitching out.

If you have alignment stitches in your split embroidery sections, each section starts with a sequence of movement stitches. These movement stitches jump to the corner of a rectangle within the stitchable area of the hoop, that is half way across the overlap between the hoop areas. For the first section, skip past these movement stitches and then start stitching out.

Aligning a Section to Previous Sections

First, ensure the fabric is straight in the hoop, according to the marked positions of the hoop centers. After selecting the embroidery on the machine, use the machine controls to position the needle over the center point marked on the fabric.

Aligning With No Alignment Stitches

Use the template or full size worksheet to confirm that the embroidery will connect correctly to previous sections. This is easier to do if you have printed the template or worksheet on transparency paper. If you created test stitchouts, this will help you judge the positioning according to the effect of the fabric properties.

Aligning With Corner or Baste Alignment Stitches

The previous sections will have placed alignment stitches that mark the corner positions, either as a small set of corner stitches or lines of basting stitch that meet at the corner. Use the machine controls to step through the sequence of movement stitches that should match up to the corners.

Adjust the machine so that the needle is over the appropriate corner for each movement stitch position. If there are no split stitch areas around the edges of the section that need joining to previous sections, your alignment should now be accurate enough to start stitching.

Note: As the number of sections that must be stitched out increases, the type of fabric and embroidery become even more relevant for obtaining a good stitchout. Accurately hooped fabric and the alignment aids will help, but test stitchouts are also important.





If the section must join to stitch areas in previous sections, use the template or full size worksheet to confirm that the embroidery will connect correctly. This is easier to do if you have printed the template or worksheet on transparency paper. If the alignment is too far out, it may be necessary to hoop up your fabric again.

Before starting to stitch, check the alignment stitches of the previous sections, and trim any that may be overlapped by the section you are about to stitch out. New alignment stitches will be added at the end of this section, to replace any that you trim.

Split Project Examples

Use the Split Project to split very large projects, or use it to split smaller projects that are still too large to fit into your largest hoop.

Split a Flower Embroidery

- 1 If required, choose File > New.
- 2 Click the Hoop button  and set the hoop size to 360mm x 200mm - Universal Large Hoop 4, Natural Orientation.
Note: This is a size that will show the whole project, not the actual hoop size which will be selected before stitching out.
- 3 Choose File > Insert. See “Insert” on page 25.
- 4 Browse to the folder /Samples/Embroidery/Stitch.
- 5 Click to load the embroidery Three Flowers.vp4.
- 6 In the Design window  of the Control Panel  click Split Project .
The Split Embroidery page of the Split Project Assistant appears.
- 7 Click the Change Hoop button to select the hoop.
The Hoop Selection dialog opens.
- 8 In the Brand pop-up menu select Universal.
- 9 In the Machine Group pop-up menu select Universal.
- 10 In the Hoop Size list, select 180 x 130mm - Universal Large Hoop 1, and in Orientation, select Natural.



Note: It is not necessary to choose the hoop orientation, as this will be set automatically to create the least number of hoopings. However, the split lines may be more pleasing in one orientation, so it is worth checking the results with both orientations.

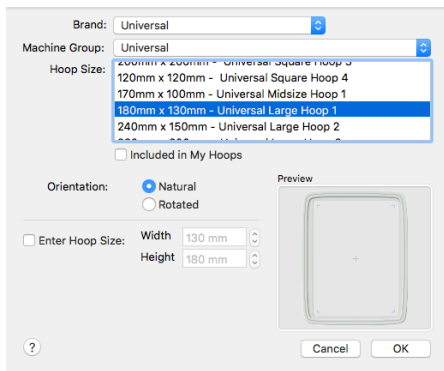

For a large embroidery that is to be split into several sections, use the largest single-part hoop available for your machine.

11 Click OK to select the hoop. When splitting your project, try to adjust your settings to minimize cutting the embroidery.

12 Check that the Intelligent Split Method is selected.
Note: Intelligent Split calculates a split line that cuts through the minimum number of stitches.

13 For Alignment Stitch Style, select None.

Note: Depending on your machine, you may prefer to choose no Alignment stitches (many machines with this hoop type have special positioning features; for example HUSQVARNA VIKING® Designer Diamond Royale or PFAFF® creative sensation Pro). For other machines, use Corner alignment, as these are lightly stitched embroideries, and there are few splits within design elements.

14 Check that Compensation is set to None as this is a relatively small project and the overlap will be set to avoid splitting heavily embroidered areas.

15 Check that Connection is set to Trim as the split lines will not cross large stitch areas.

16 Ensure that Overlap is set at the default of 50mm.

17 Click Continue. The Save Embroidery page appears.

18 Use the Next ► and Previous ◀ buttons to step through the sections and check the split lines for the whole design.

19 The split line has cut through the tip of one of the petals of the flower on the left. Click Go Back to change the overlap.

20 Set the Overlap to 55mm, then click Continue. The split line no longer cuts the flower.

Note: You can adjust the Overlap to avoid splitting an area. Increasing or decreasing overlap may make it easier for Intelligent Split to fit all of an embroidery into one section, or to cut the embroidery in an inconspicuous place.

21 Click Export All Sections to save the project as numbered sections. The Export dialog appears. See “Export” on page 33.

22 In File Format, ensure that .vp4 is selected, then click Continue.

Note: The preferred file format for saving embroideries is .vp4, as this will preserve the separate parts of multipart designs. It also preserves thread color information and notes.

23 In the Saving as dialog, browse to the folder mySewnet/My Designs.

24 Click New Folder, and name the new folder Three Flowers. Then browse to the new folder.

25 In the Save as box, enter the name ‘Three Flowers’, then click Save.

Note: The files are saved as the files Three Flowers_01 to Three Flowers_03. Creating a new folder makes it easier to find all the sections.

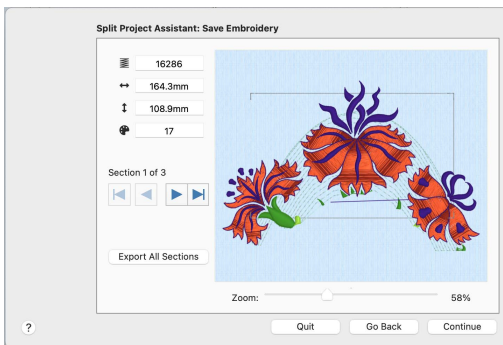
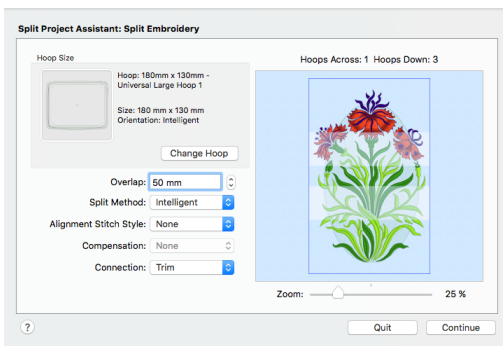

26 Click Continue. The Print Options page appears.
Note: If you have not saved the files a warning message will be displayed.

27 In the Overview area, click Print.

28 In the Print dialog click Print to start printing. An overview of how the embroidery was split is printed.
Note: The Overview shows how the embroidery was split, how each split section was named, and the number of stitches involved. Use this to decide the best order for stitching out the split sections.

29 In the Complete Template area click Print, and then Print. (If necessary, change printing to a single side.) A full-size template of the split embroidery sections is printed, with an outline around each section to indicate how to join them together.
Cut out the template and attach the sections as a guide for positioning fabric within the hoop.

30 In the Worksheets area, click Print.

31 In the Print dialog, click Show Details, then set Design Scale to 50%, and click Print to print the worksheets.



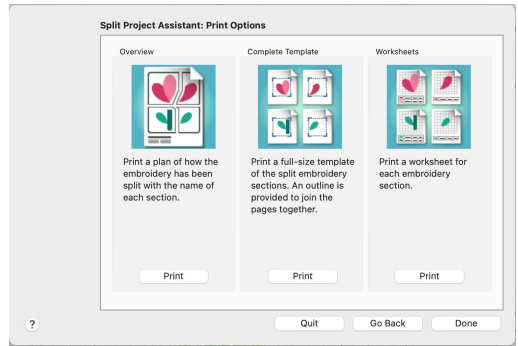

Note: The worksheets give the dimensions of the section, the number of stitches, information on the thread colors used and the Notes and Settings for the embroidery.

32 Click Done to close the Split Project Assistant.



Decorate your chosen background and embroidery with ribbon, yarn, strings of beads, and decorations such as sequins, beads, hotfix crystals or nailheads.

Creating Embellishments

Add Ribbon , Yarn , Strings of Beads  to your design for the Embellishment Attachment, or place an indicator line for sewing with a specialist foot. Choose a color and width in the Selection dialog, then draw lines and shapes, or add a Gallery  design.

For Decorations , choose the desired embellishment in the Decoration Selection dialog, then click to place decorations one at a time, or in lines or shapes.

Adjust the placing and type of embellishments in your project using Edit Points  or the Context menu.

Embellish Window

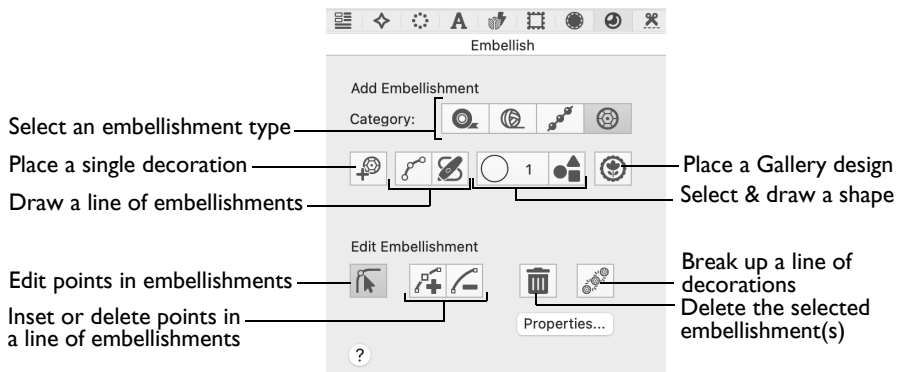

Use the Embellish window to add embellishments to your design.





To Open the Embellish Window

- Click Control Panel , then click Embellish .

To learn how to	Go to
Choose ribbon, yarn, strings of beads or decorations	See “Select an Embellishment Type” on page 157.
Draw freehand to place a line of embellishments	See “Draw Freehand Line” on page 158.
Place points to create a line	See “Draw Point Line” on page 159.

To learn how to	Go to
Place an embellishment shape	See “Place Shape” on page 159.
Insert an embellishment design from a Gallery	See “Insert from Gallery” on page 160.
Select embellishments for editing	See “Edit Points” on page 172.
Add ribbon to a design	See “Ribbon” on page 160.
Add yarn to a design	See “Yarn” on page 163.
Add a string of beads to a design	See “String of Beads” on page 166.
Add single sequins or beads to a design	See “Place Individual Beads on an Embroidery” on page 169.
Draw lines of decorations	See “Draw Lines of Decorations” on page 170.
Select and change decorations	See “Resizing and Reshaping Decorations and Lines” on page 172.
Add a decorations to an embroidery	See “Sequin Snow” on page 176 and “Decorated Bells” on page 178
Create and adjust a decoration shape	See “Edit a Bead Crescent” on page 180.
Change a Decoration Gallery design	See “Bear on Beanie Hat” on page 182.

Select an Embellishment Type

Choose a type of embellishment for your design. In Category, select Ribbon , Yarn , String of Beads , or Decorations  for beads, sequins, hotfix crystals or nailheads.





- See “Ribbon” on page 160.
- See “Yarn” on page 163.
- See “String of Beads” on page 166.
- See “Decoration” on page 169.

When a design is exported for stitching out, Embellishments are placed last in the stitchout order. You can view this order in the Design Player .

First, all of the embroidery apart from Embellishments is stitched. After this the indicator stitches for Decorations, followed by Yarn, Ribbon and Strings of Beads are stitched. In the Design Player , pictures of the Decorations that you would stitch or glue by hand are shown last.

Note: The settings in the Export dialog, and in the Export tab in mySewnet™ Configure do not affect this stitch order.

Drawing and Placing Embellishments

Use Draw Freehand Line  or Draw Point Line  to draw lines of Embellishments, Place Shapes , or use a ready made design with Insert from Gallery .

Note: You can also place individual Decorations with Place Individual . See “Place Individual” on page 169.



For ribbon, yarn and strings of beads, draw or place your embellishments within the green rectangle on the work area. The green rectangle indicates the area accessible to the Embellishment Attachment within the selected hoop.

Note: Hoops used with the Embellishment Attachment must be at least 200mm wide or high. Turnable hoops cannot be used with the Embellishment Attachment.

Draw Freehand Line

Use Draw Freehand Line  to drag to draw a line of embellishments.



To draw a line of embellishments with Draw Freehand Line

In the Embellish window  click Draw Freehand Line  and choose the settings for your selected Embellishment type in the selection dialog. Then drag to draw a line.

- For ribbon, select color and width in the Ribbon Selection dialog (see “Ribbon Selection” on page 162).
- For yarn, select color and size in the Yarn Selection dialog (see “Yarn Selection” on page 165).
- For a String of Beads, select color and size in the String of Beads Selection dialog (see “String of Beads Selection” on page 168).
- For Decorations, select a decoration type, material, color, size and angle in the Decoration Selection dialog (see “Decoration Selection” on page 174).

Note: Use Edit Points  and Properties or the Context menu to make changes to the line. See “Edit Points” on page 172.

Draw a Freehand Line of Embellishments

- 1 In the Add Embellishment section of the Embellish window, select an Embellishment type.
- 2 Click Draw Freehand Line . The properties dialog for your Embellishment type opens. Select the Embellishment settings and click OK. The pointer changes to the pen pointer .
- 3 Drag to draw some lines.
- 4 Control-click when you have placed the lines and select "Finish Draw Freehand..." from the Context menu.



To change the Embellishments later, use Edit Points  and Properties. See “Edit Points” on page 172.

Draw Point Line

Use Draw Point Line  to place points to draw a line of embellishments.

Note: Point Line may be easier to use than Freehand Line for precise drawing.

To draw a line of embellishments with Draw Point Line

In the Embellish window  click Draw Point Line  and choose the settings for your selected Embellishment type in the selection dialog. Then drag to draw a line.

- For ribbon, select color and width in the Ribbon Selection dialog (see “Ribbon Selection” on page 162).
- For yarn, select color and size in the Yarn Selection dialog (see “Yarn Selection” on page 165).
- For a String of Beads, select color and size in the String of Beads Selection dialog (see “String of Beads Selection” on page 168).
- For Decorations, select a decoration type, material, color, size and angle in the Decoration Selection dialog (see “Decoration Selection” on page 174).

Note: Use Edit Points  and Properties or the Context menu to make changes to the line. See “Edit Points” on page 172.

Draw a Point Line of Embellishments

- 1 In the Add Embellishment section of the Embellish window, select an Embellishment type.
- 2 Click Draw Point Line . The properties dialog for your Embellishment type opens. Select the Embellishment settings and click OK.
- 3 Place points to draw a line.
- 4 Control-click when you have placed the line, and select “Finish Draw Point...” from the Context menu.
- 5 Draw other lines.
- 6 Control-click when you have finished placing lines and select “Finish placing line” from the Context menu.

To change the Embellishments later, use Edit Points  and Properties. See “Edit Points” on page 172.

Place Shape

Use Place Shape  to draw a shaped line on your project, using the shape currently selected in the gallery of preset shapes.

Note: Once placed, a decoration shape is treated as a line of decorations.

- For ribbon, select color and width in the Ribbon Selection dialog (see “Ribbon Selection” on page 162).
- For yarn, select color and width in the Yarn Selection dialog (see “Yarn Selection” on page 165).

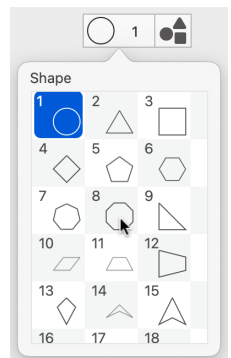

- For a String of Beads, select color and size in the String of Beads Selection dialog (see “String of Beads Selection” on page 168).
- For Decorations, select a decoration type, material, color, size and angle in the Decoration Selection dialog (see “Decoration Selection” on page 174).

The shape is shown as an embellishment line, with handles to resize, flip and rotate the shape. To move the shape, click and drag inside the shape.

Resize the shape with the resize handles on the corners. Hold down Shift as you click and drag to retain the current proportions of the shape. Hold down Option to resize from the center. Rotate the shape with the circular rotate handle on the right. Mirror the shape horizontally or vertically with the triangular flip handles on the left and top.

Note: For best results when resizing shapes with sharp points, it is recommended to hold down Shift so that the shape is perfectly in proportion.



Use Edit Points  and Properties or the Context menu to make changes to your shape. See “Edit Points” on page 172.

Insert from Gallery

Use Insert from Gallery  to select a design from one of the Design Galleries.

See “Ribbon Gallery Designs” on page 162, “Yarn Gallery Designs” on page 165, “String of Beads Gallery Designs” on page 168 and “Decoration Gallery Designs” on page 171.





Load a Gallery Design

In the Category section of the Embellish window , select an Embellishment type, then select Insert from Gallery . In the Viewer, scroll down and click to highlight the desired design. Click OK to load the design.

Ribbon

Add ribbon  to your design for use with the Embellishment Attachment (or the Ribbon Attachment), or place an indicator line for sewing with a standard ribbon foot. Choose a color and width in the Ribbon Selection dialog, then draw ribbon lines and shapes, or add a Ribbon Gallery design.

Note: Draw or place your line of ribbon within the green rectangle on the work area.

Draw lines of ribbon with Draw Freehand Line  or Draw Point Line , use Place Shape , or insert a design with Insert from Gallery .

Note: Use Edit Points  and Properties or the Context menu to make changes to the ribbon. See “Edit Points” on page 172.

Designing with Ribbon





Place your ribbon lines and designs to work with your Embellishment Attachment. Any ribbon should be placed within the green rectangle.

Note: The green rectangle indicates the area accessible to the Embellishment Attachment within the selected hoop. To stitch ribbon in a wider area, select a larger hoop.

- When designing with ribbon, use a continuous line where possible, and plan your start and end before placing your design. Ribbon lines cannot be split.
- Avoid very sharp corners, and do not use loops smaller than 5mm in diameter.
- You can stitch over another ribbon line, but not more than twice.



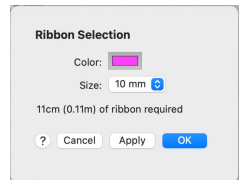

Note: Turnable hoops cannot be used with the Embellishment Attachment.

Draw a Line of Ribbon

- 1 In the Category section of the Embellish window , select Ribbon .
- 2 Click Draw Freehand Line . The Ribbon Selection dialog opens.
- 3 Select a ribbon color and size, then click OK to close the Ribbon Selection dialog.
The pointer changes to the pen pointer .
- 4 Draw lines for the ribbon.
- 5 Control-click when you have placed the ribbon and select "Finish Draw Freehand Ribbon Line" from the Context menu.
- 6 To change the ribbon later, use Edit Points  and Properties. See "Edit Points" on page 172.







Place Points for a Line of Ribbon

- 1 In the Category section of the Embellish window , select Ribbon .
- 1 Click Draw Point Line . The Ribbon Selection dialog opens.
- 2 Select a ribbon color and size, then click OK to close the Ribbon Selection dialog.
The pointer changes to the Point pointer .
- 3 Click to place points for a line for the ribbon.
- 4 Control-click when you have placed the line, and select "Finish Draw Point Ribbon Line" from the Context menu. Draw any other lines.
- 5 Control-click when you have placed the ribbon and select "Finish placing line" from the Context menu.

Note: Use Edit Points  and Properties or the Context menu to make changes to the ribbon afterwards. See "Edit Points" on page 172.



Draw a Ribbon Shape

- 1 In the Category section of the Embellish window , select Ribbon .
- 2 Click the displayed shape, and in the popup list select a shape.
- 3 Click Place Shape . The Ribbon Selection dialog appears.
- 4 Select a ribbon color and width, then click OK to close the Ribbon Selection dialog. The shape is shown on the work area.

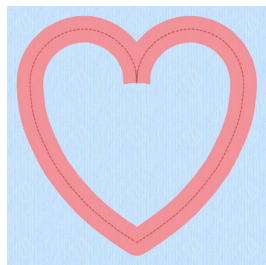

- 5 Drag one of the corner handles to enlarge or shrink the shape.
Note: Hold down Shift to retain the original proportions. Hold down Option to resize from the center.
- 6 Rotate the shape with the circular rotate handle on the right.
- 7 Use the triangular flip handles on the left and top to mirror the shape horizontally or vertically.
- 8 Move the pointer over the shape. The pointer changes to the move pointer .
- 9 Drag the shape to the desired position.
Note: To change the ribbon later, use Edit Points  and Properties. See “Edit Points” on page 172.



Ribbon Gallery Designs

With Ribbon  selected, use Insert from Gallery  to insert a Ribbon design into your current project. Change the size and color to complement your project.

Load a Ribbon Gallery Design

In the Category section of the Embellish window , select Ribbon , then select Insert from Gallery . In the Viewer, scroll down and click to highlight the desired design. Click OK to load the ribbon design.

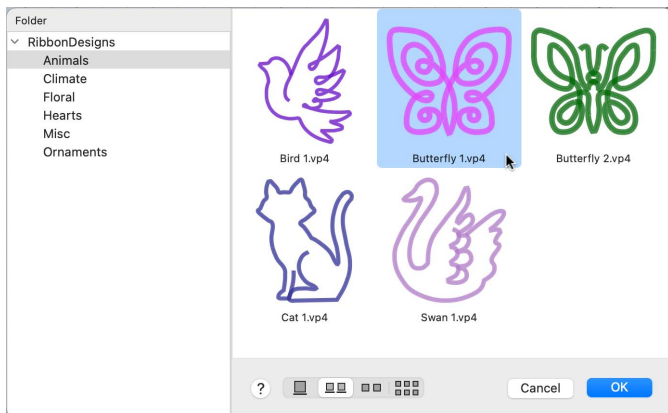

Ribbon Selection

Use the Ribbon Selection dialog to choose a color and width for your ribbon. The length of ribbon needed for the line or shape is displayed.

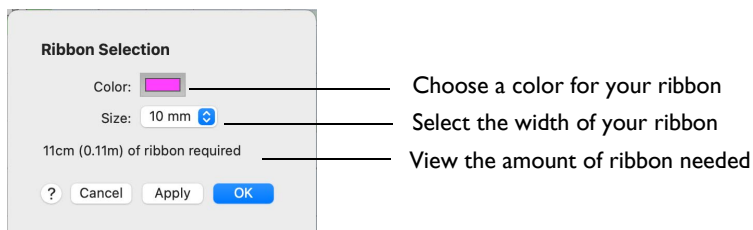

Use Edit Points  to choose a piece of ribbon on the work area for editing. See “Edit Points” on page 172.

Color

Click to choose a color in the Colors window. See “Colors Window” on page 83.

Size

Select the ribbon width from the popup menu. The available sizes are 5mm, 6mm, 7mm, 8mm, 9mm, 10mm, 11mm and 12mm.





When a piece of ribbon is selected, a message shows how much ribbon will be needed.

Yarn

Adding Yarn

Add Yarn  to your design for the Embellishment Attachment, or place an indicator line for sewing with a standard yarn foot. Choose a color and width in the Yarn Selection dialog, then draw yarn lines and shapes, or add a Yarn Gallery design.

Note: Draw or place your line of yarn within the green rectangle on the work area.

Draw a line of yarn with Draw Freehand Line  or Draw Point Line , use Place Shape , or add a design with Insert from Gallery .

Note: Use Edit Points  and Properties or the Context menu to make changes to the yarn. See “Edit Points” on page 172.

Designing with Yarn

Place your yarn lines and designs to work with your Embellishment Attachment. Any yarn should be placed within the green rectangle.

Note: The green rectangle indicates the area accessible to the Embellishment Attachment within the selected hoop. To stitch yarn in a wider area, select a larger hoop.



When designing with yarn, use a continuous line where possible, and plan your start and end before placing your design. Yarn lines cannot be split.

Avoid very sharp corners, and do not use very small loops.

Take care when stitching over another yarn line, depending on the yarn type.

Note: Turnable hoops cannot be used with the Embellishment Attachment.

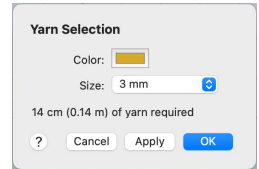

Draw a Line of Yarn

- 1 In the Category section of the Embellish tab, select Yarn .
- 2 Click Draw Freehand Line . The Yarn Selection dialog appears.
- 3 Select a yarn color and size, then click OK to close the Yarn Selection dialog.
The pointer changes to the pen pointer .
- 4 Draw a line for the yarn.
- 5 Right-click when you have placed the yarn and select "Finish placing line" from the Context menu.





Note: To change the yarn later, use Edit Points  and Properties. See “Edit Points” on page 172.

Place Points for a Line of Yarn

- 1 In the Category section of the Embellish tab, select Yarn .
- 2 Click Draw Point Line . The Yarn Selection dialog appears.
- 3 Scroll down and select a yarn color and size, then click OK to close the Yarn Selection dialog.
The pointer changes to the Point pointer .
- 4 Click to place points for a line for the yarn.
- 5 Control-click when you have placed the line, and select "Finish Draw Point Yarn Line" from the Context menu. Draw any other lines.
- 6 Right-click when you have placed the yarn and select "Finish placing line" from the Context menu.

Note: To change the yarn later, use Edit Points  and Properties. See “Edit Points” on page 172.

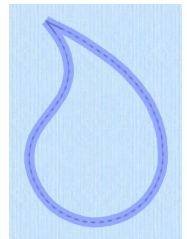

Draw a Yarn Shape

- 1 In the Category section of the Embellish tab, select Yarn .
- 2 Click the drop-down arrow to the right of the shapes gallery and select a shape from the list.
- 3 Click Place Shape . The Yarn Selection dialog appears.
- 4 Select a yarn color and size, then click OK to close the dialog. The yarn shape is shown.
- 5 Click and drag on one of the corner handles to enlarge or shrink the shape.
Note: Hold down Shift to retain the original proportions. Hold down Option to resize from the center.
- 6 Move the pointer over the shape. The pointer changes to the move pointer .
- 7 Click and drag the shape to the desired position.





Note: To change the yarn later, use Edit Points  and Properties. See “Edit Points” on page 172.

Yarn Gallery Designs

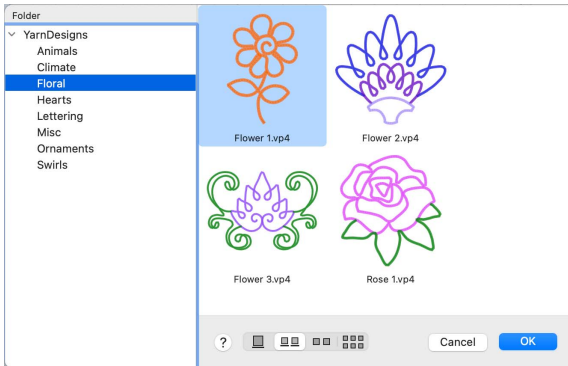
With Yarn  selected, use Insert from Gallery  to insert a Yarn design into your current project. Change the size and color to complement your project.



Click Insert from Gallery  and in the File Viewer dialog, click to highlight the desired design. Click Open to load the design.

Note: Use Edit Points  and Properties or the Context menu to change the size and color of the yarn in the design.

Yarn Selection

Use the Yarn Selection dialog to choose a color and thickness (size) for your yarn. The length of yarn needed for the line or shape is displayed.

Note: Use Edit Points  to select a piece of yarn on the work area for editing. See “Edit Points” on page 172.

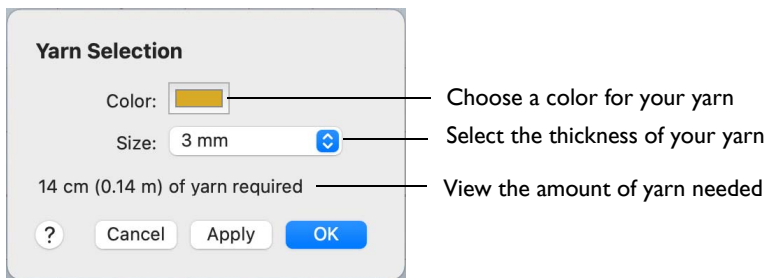

Color

Click to choose a color in the Colors window. See “Colors Window” on page 83.

Size

Select the yarn size from the popup menu. The available sizes are 1mm, 2mm, 3mm, 4mm and 5mm.





When a piece of yarn is selected, a message shows how much will be needed.

String of Beads

Adding Strings of Beads

Add Strings of Beads  to your design for the Embellishment Attachment, or place an indicator line for sewing with a bead foot. Choose a color and width in the String of Beads Selection dialog, then draw lines and shapes, or add a String of Beads Gallery design.

Note: Draw or place your Strings of Beads within the green rectangle on the work area.

Draw a string of beads with Draw Freehand Line  or Draw Point Line , use Place Shape , or add a design with Insert from Gallery .

Note: Use Edit Points  and Properties or the Context menu to make changes to the String of Beads. See “Edit Points” on page 172.

Designing with Strings of Beads

Place your bead lines and designs to work with your Embellishment Attachment. Any Strings of Beads should be placed within the green rectangle.

Note: The green rectangle indicates the area accessible to the Embellishment Attachment within the selected hoop. To stitch Strings of Beads in a wider area, select a larger hoop.

When designing with Strings of Beads, use a continuous line where possible, and plan your start and end before placing your design. String of Beads lines cannot be split.

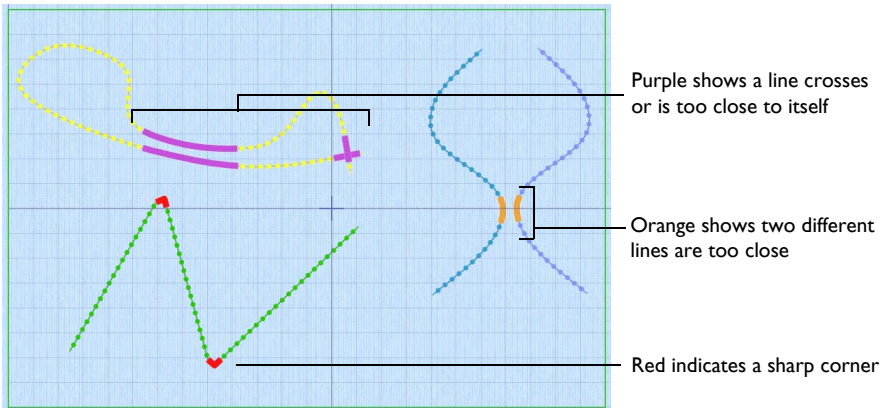



Warning colors indicate problems with the design:

- Red indicates that the angle of a corner is too sharp (over 60 degrees). Adjust the points in the line to smooth the curve.
- Purple indicates that the line is too close to itself, or crosses itself. Change the line so that no parts are too close.

- Orange indicates that two lines are too close to each other. Move them apart.

Note: Turnable hoops cannot be used with the Embellishment Attachment.

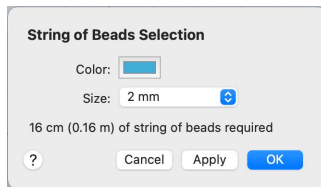

Draw a String of Beads

- 1 In the Category section of the Embellish tab, select String of Beads .
- 2 Click Draw Freehand Line . The String of Beads Selection dialog appears.
- 3 Select a bead color and size, then click OK to close the String of Beads Selection dialog.
The pointer changes to the pen pointer .
- 4 Draw a line for the String of Beads.
- 5 Right-click when you have placed the bead line and select "Finish placing line" from the Context menu.





Note: To change the String of Beads later, use Edit Points  and Properties. See "Edit Points" on page 172.

Place Points for a String of Beads

- 1 In the Category section of the Embellish tab, select String of Beads .
- 2 Click Draw Point Line . The String of Beads Selection dialog appears.
- 3 Scroll down and select a bead color and size, then click OK to close the String of Beads Selection dialog.
The pointer changes to the Point pointer .
- 4 Click to place points for a line for the beads.
- 5 Control-click when you have placed the line, and select "Finish Draw Point String of Beads Line" from the Context menu. Draw any other lines.
- 6 Right-click when you have placed the String of Beads and select "Finish placing line" from the Context menu.

Note: To change the String of Beads later, use Edit Points  and Properties. See "Edit Points" on page 172.

Draw a String of Beads Shape

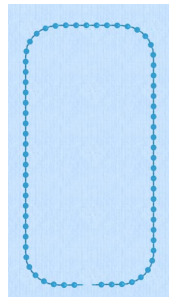

- 1 In the Category section of the Embellish tab, select String of Beads .
- 2 Click the drop-down arrow to the right of the shapes gallery and select a shape from the list.
Note: In general, lines work better for bead strings than closed shapes, but for instance, an opened shape may make a good highlight for a frame.
- 3 Click Place Shape . The String of Beads Selection dialog appears.
- 4 Select a bead color and size, then click OK to close the dialog. The String of Beads shape is shown.





- 5 Click and drag on one of the corner handles to enlarge or shrink the shape.
Note: Hold down Shift to retain the original proportions. Hold down Option to resize from the center.
- 6 Move the pointer over the shape. The pointer changes to the move pointer .
- 7 Click and drag the shape to the desired position.

Note: To change the String of Beads later, use Edit Points  and Properties. See "Edit Points" on page 172.

String of Beads Gallery Designs

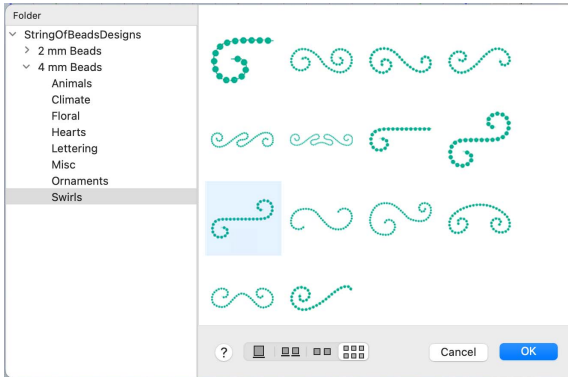
With Strings of Beads  selected, use Insert from Gallery  to insert a String of Beads design into your current project. Change the size and color to complement your project.



Click Insert from Gallery  and in the File Viewer dialog, scroll down and click to highlight the desired design. Click Open to load the design.

Note: Use Edit Points  and Properties or the Context menu to change the size and color of the beads in the design.

String of Beads Selection

Use the String of Beads Selection dialog to choose a color and size for your beads. The length of bead string needed for the line or shape is displayed.

Note: Use Edit Points  to select a string of beads on the work area for editing. See “Edit Points” on page 172.

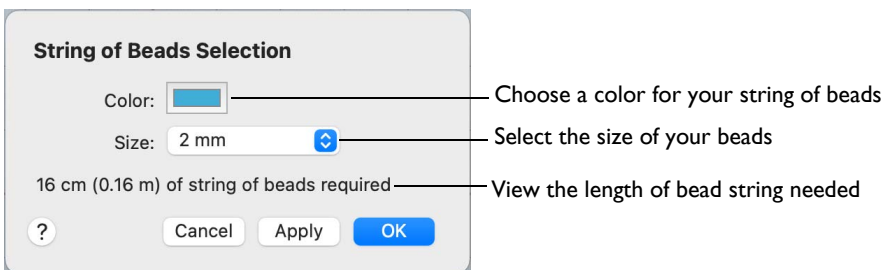

Color







Click to choose a color in the Colors window. See “Colors Window” on page 83.

Size

Select the bead size from the popup menu. The available sizes are 2mm and 4mm. When a string of beads is selected, a message shows how much will be needed.

Decoration

Adding Decorations

Add Decorations  such as beads, sequins, crystals or nailheads to your project as individual decorations with Place Individual , or as lines of decorations with Draw Freehand Line , Draw Point Line  or Place Shape . Insert a special design with decorations using Insert from Gallery .



Decorations are added as a decoration subdesign or to an existing decoration subdesign if one is selected.

Note: Use Edit Points  and the Properties button or the Context menu to make changes to the line of decorations. See “Edit Points” on page 172.



Place Individual

Use Place Individual  to place decorations individually on your project.

To place a decoration with Place Individual

- In the Category section of the Embellish window , select Decoration , then click Place Individual  and select a decoration type, material, color, size and angle in the Decoration Selection dialog. Click to place decorations. Undo to remove the last decoration.

Place Individual Beads on an Embroidery

- 1 Load the desired background and embroideries.
- 2 Position the embroideries as desired.
- 3 In the Category section of the Embellish window , select Decoration .
- 4 Click Place Individual .

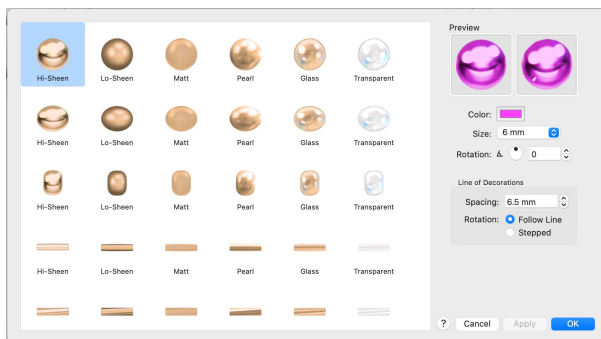



- 5 In the Decoration Selection dialog, click to select the desired bead type and material. See “Decoration Selection” on page 174.
- 6 Click Color and use the Colors window to select a color.
- 7 Set the desired bead Size, and use Rotation to set the bead angle.
- 8 Click OK to close the Decoration Selection dialog.

Note: The pointer changes to the Insert pointer  to show that you may place beads.





- 9 Click in the work area to place the bead. Each click will place one bead.
Use Undo to remove the last bead.
Note: Drag has no effect while placing beads.
- 10 When you have placed all the beads as desired, Control-click and select "Finish placing individual" in the Context menu to end.
- 11 Repeat the process to place more beads.
- 12 Choose File > Export Decoration Template to create a crystal transfer template (or rhinestone template) for pressing hotfix crystals and nailheads directly onto your work. See "Export Decoration Template" on page 41.

Draw Lines of Decorations

Use Draw Freehand Line  and Draw Point Line  to place lines of decorations on your project. Select a bead, sequin, crystal or nailhead using your preferred material, size and color in the Decoration Selection dialog, and then draw your line.





Note: You can select the angle of Rotation, and choose whether the line of decorations will follow the line drawn (Follow Line), or if they will use the angle set in rotation (Stepped).

Draw a Line of Decorations

- 1 In the Category section of the Embellish window , select Decoration .
- 2 Select Draw Freehand Line . The Decoration Selection dialog appears.
- 3 Scroll down and select a decoration type, material, color, size, rotation and spacing. See "Decoration Selection" on page 174.
- 4 In Line of Decorations, select whether the line of decorations will follow the line drawn (Follow Line), or if it will use the angle set in rotation (Stepped).
- 5 Click OK to close the Decoration Selection dialog.
The pointer changes to the freehand pointer .
- 6 Drag to draw a line for the beads. When you release the mouse the line is drawn automatically.
- 7 Control-click when you have placed the decorations and select "Finish placing line" from the Context menu.





Place Points for a Line of Decorations

- 1 In the Category section of the Embellish window , select Decoration .
- 2 Select Draw Point Line . The Decoration Selection dialog appears.
- 3 Scroll down and select a decoration type, material, color, size, rotation and spacing. See "Decoration Selection" on page 174.
- 4 In Line of Decorations, select whether the line of decorations will follow the line drawn (Follow Line), or if it will use the angle set in rotation (Stepped).
- 5 Click OK to close the Decoration Selection dialog.
The pointer changes to the Point pointer .
- 6 Click a series of points to create a line of decorations. Press Shift to place a straight line or corner point.

- Control-click when you have placed the decorations and select "Finish placing line" from the Context menu.

Draw a Decoration Shape

- In the Category section of the Embellish window , select Decoration .
- Click the current shape and choose a shape from the pop-up menu.
- Click Place Shape . The Decoration Selection dialog appears.
- Scroll down and select a decoration type, material, color, size and spacing, then click OK to close the Decoration Selection dialog. The shape is shown in a selection box.
- Drag one of the corner handles to enlarge or shrink the shape.

Note: Hold the Shift key while dragging to retain the original proportions. Hold the Option key while dragging to resize from the center.

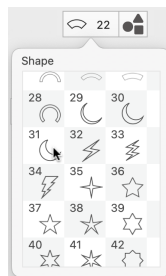

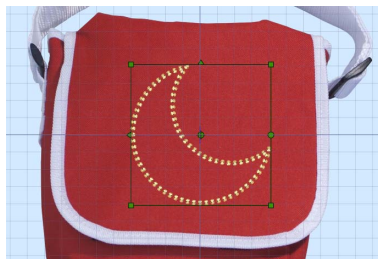

Use the circular rotate handle on the right to rotate the shape. Mirror the shape horizontally or vertically with the triangular flip handles on the left and top.

Note: For best results when resizing shapes with sharp points, it is recommended to hold the Shift key so that the shape is perfectly in proportion.



- Move the pointer over the shape. The pointer changes to the move pointer .
- Drag the shape to the desired position.



Decoration Gallery Designs

With Decoration  selected, use Insert from Gallery  to insert a Decoration design into your current project. Change the size, color and decoration type to complement your project.

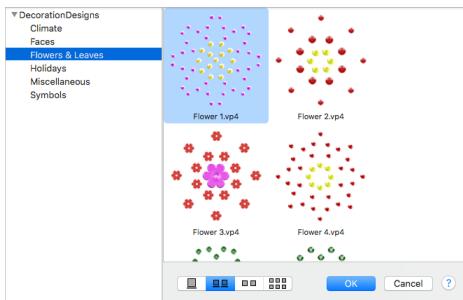



Note: Use Edit Points  and the Properties button or the Context menu to make changes to the line of decorations. See "Edit Points" on page 172.



To create a Decoration Gallery Design

- In the Category section of the Embellish window , select Decoration , then select Insert from Gallery . In the Viewer, scroll down and click to highlight the desired design. Click OK to load the decoration design.

Editing Embellishments



Use Edit Points  to select single decorations positioned with Place Individual , or lines placed with Draw Freehand Line  and Draw Point Line  or Place Shape . You can adjust or delete individual decorations, and insert or delete points along lines of decorations, or break up or delete complete lines of decorations.

Note: Use the Context menu to change decorations when in other mySewnet™ Embroidery windows.

Edit Points





Use Edit Points  to select individual decorations, or lines of Embellishments for editing or deleting.

To select embellishments

- In the Embellish window , click Edit Points  then click the desired Embellishment(s). The Embellishments will be selected.
- To change color, size or material, click Edit Points  and select an Embellishment, then click the Properties button to open the selection dialog for the Embellishment type.
- To select decorations within a subdesign, Control-click the decoration subdesign and select all decorations of a specific type from the Context menu.
- Use Command and click to select a number of individual decorations, for instance to change the color for some beads in a Gallery design.

Adjust or remove the selected item as desired. When a decoration line or shape is enlarged, the number of decorations increases. It decreases as the line or shape is made smaller.

Resizing and Reshaping Decorations and Lines

- 1 In the Category section of the Embellish window , select Decoration .
- 2 Click Insert from Gallery  and in the Viewer select 'Bear Lg 1' in the Faces folder. Click OK to load it in the work area.
- 3 Click Edit Points , then click one of the beads in the bear's ears. This selects a single bead, as the bead has been placed individually. *Note:* Edit Points enables you to change individual beads and lines in a Decoration Gallery design or other subdesign.
- 4 Click one of the beads in the outline of the bear's face. This bead is part of a line of beads.
- 5 Control-click, and select "Finish selecting embellishments" in the Context menu.
- 6 Drag one of the green corner handles for the Decoration design to make it larger.

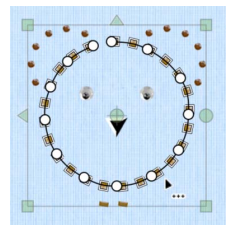



The beads placed individually become more widely spaced. If desired, place individual additional decorations, or adjust the size. The line forming the outline of the bear's face shows an increased number of beads as the circle enlarges.

Note: When a line or shape is enlarged, the number of decorations increases. It decreases as the line or shape is made smaller.

Insert Points

Use Insert Points  to add new points to the currently selected line of embellishments.

To insert points in a line of embellishments



- Select the desired line of embellishments, then click Insert Points . With the Insert pointer , click to add a point to the line. Control-click to finish adding points.

Note: Press Shift to place a straight line or corner point.

Delete Points

Use Delete Points  to delete points from the currently selected Line of embellishments.

To delete points from a line of embellishments

- Select the desired line of embellishments, then click Delete Points . With the Delete pointer , click to remove a point from the line. Control-click to finish deleting points.

Delete Selection

Use Delete Selection  to delete the currently selected individual embellishment, or line of embellishments.

To delete the selected embellishment or line

- Select the desired individual embellishment or line of embellishments, then click Delete Selection . The selected item is removed from the work area.

Break Up Line

Use Break Up Line  to break up the currently selected line of decorations into individual decorations for independent editing.

To break up a line of decorations

- Select the desired line of decorations, then click Break Up Line . The selected line of decorations now consists of individual decorations which can be changed separately.

Note: Use Break Up Line to create a line or shape with alternating colors. Once the line or shape has been broken into individual decorations, select alternate decorations, and click the Properties button change the color for each bead.

Decoration Selection



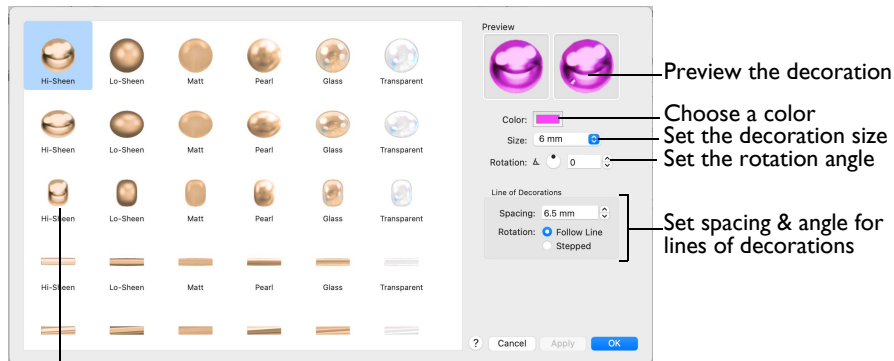

Use the Decoration Selection dialog to choose beads and sequins.



Select a decoration shape and material

All decorations are available in the following materials: Hi-Sheen, Lo-Sheen, Matt, Pearl, Glass and Transparent.

Select a decoration

- 1 In the Category section of the Embellish window , select Decoration .
- 2 Click Place Individual . The Decoration Selection dialog appears.
- 3 Select a decoration type and style from the table.
Note: Place the pointer over the decorations to see the names. The bead materials are Hi-Sheen, Lo-Sheen, Matt, Glass and Transparent.
- 4 Click the Color button, and select a color in the Colors window. See “Colors Window” on page 83.
- 5 Choose the decoration size in the Size pop-up menu.
The available sizes are different for each type of decoration. See “Decorations” on page 175.
- 6 Use the up and down arrows or enter an angle  from 0 to 359 degrees in the angle box to set the rotation of the decoration.
- 7 For a line of decorations you can set the Spacing between the decorations in the line or shape, and select whether the decorations will follow the line drawn, or if they will use the angle set in rotation (Stepped).
Note: The settings for Line are only relevant when a line is used.
- 8 Click OK to select the decoration, and close the Decoration Selection dialog.
- 9 Place the decorations as desired.

Decorations

The following types of decorations are available, in a variety of colors, materials and sizes:

Shape	Size (in mm)	Shape	Size (in mm)
 Round	4, 5, 6, 7, 8, 9, 10	 Crystal Rectangular	3, 4, 5, 6, 7, 8, 9, 10
 Oval	4, 5, 6, 7, 8, 9, 10	 Crystal Round	1.0, 1.5, 2.0, 2.5, 3.0, 3.5, 4.0, 4.5, 5.0, 6.0, 7.0, 8.0, 9.0, 10.0, 12.0
 Seed	1.0, 1.5, 2.0, 2.5, 3.0	 Crystal Square	3, 4, 5, 6, 7, 8, 9, 10
 Bugle	4, 5, 6, 7, 8, 9, 10	 Crystal Triangle	3, 4, 5, 6, 7, 8, 9, 10
 Bugle Twisted	4, 5, 6, 7, 8, 9, 10	 Nailhead Diamond	3, 4, 5, 6, 7, 8, 9, 10
 Sequin Cup	2, 3, 4, 5, 6, 7, 8, 9, 10	 Nailhead Heart	3, 4, 5, 6, 7, 8, 9, 10
 Sequin Flat	2, 3, 4, 5, 6, 7, 8, 9, 10, 15, 20	 Nailhead Petal	3, 4, 5, 6, 7, 8, 9, 10
 Sequin Flower	2, 3, 4, 5, 6, 7, 8, 9, 10, 15, 20	 Nailhead Rectangular	3, 4, 5, 6, 7, 8, 9, 10
 Sequin Heart	2, 3, 4, 5, 6, 7, 8, 9, 10, 15, 20	 Nailhead Round	1.0, 1.5, 2.0, 2.5, 3.0, 3.5, 4.0, 4.5, 5.0, 6.0, 7.0, 8.0, 9.0, 10.0, 12.0
 Sequin Snowflake	2, 3, 4, 5, 6, 7, 8, 9, 10, 15, 20	 Nailhead Star	3, 4, 5, 6, 7, 8, 9, 10
 Sequin 5-Point Star	2, 3, 4, 5, 6, 7, 8, 9, 10, 15, 20	 Nailhead Teardrop	3, 4, 5, 6, 7, 8, 9, 10
 Sequin 6-Point Star	2, 3, 4, 5, 6, 7, 8, 9, 10, 15, 20	 Nailhead Triangle	3, 4, 5, 6, 7, 8, 9, 10
 Crystal Oval	3, 4, 5, 6, 7, 8, 9, 10		

Note: The Preview shows the decorations in two orientations so you can visualize their placement accurately.

Sizes for Crystal Round and Nailhead Round Decorations

1.0, 1.5 (SS 3-4, PP 7-10), 2.0 (SS 5-6, PP 11-15), 2.5 (SS 7-9, PP 16-20), 3.0 (SS 10-12, PP 21-24), 3.5 (SS 13-14, PP 25-28), 4.0 (SS 15-17, PP 29-32), 4.5, 5.0 (SS 18-22), 6.0 (SS 23-28), 7.0 (SS 29-33), 8.0 (SS 34-38), 9.0 (SS 39-42), 10.0 (SS 43-45), 12.0 (SS 46-50)

Note: When purchasing round crystals, nailheads or rhinestones, manufacturers' sizes may use the term SS (stone size) or PP (pearl plate).

Exporting Decorations

You can save a template for all your decorations in a format for your cutter. This can be used to create a Crystal Transfer Template (Rhinestone Template) for pressing hotfix crystals and nailheads directly onto your work.

To save a decoration template

- Choose File > Export Decoration Template and choose your settings in the Export Decoration Template dialog. See "Export Decoration Template" on page 41.

Center or Line Placement







Center or Line placement stitches are created automatically for decorations according to the options set in mySewnet™ Configure, which may be altered when you export the embroidery.

Note: Alternatively, create a crystal transfer template (rhinestone template) for automated cutters for pressing hotfix crystals and nailheads directly on your work with File > Export Decoration Template.

Center placement stitches are recommended when most decorations are individual and symmetrical. Line placement stitches are recommended when most decorations are individual and asymmetrical (such as bugle beads) or lines of closely spaced beads or sequins.

Using and Adjusting Decorations

Sequin Snow

- 1 Click Hoop  in the toolbar, and in the Hoop Selection dialog select 170mm x 100mm - Universal Midsize Hoop 1.
- 2 Set Orientation to Natural and click OK.
- 3 Choose File > Insert.
- 4 Browse to mySewnet/Samples/Embroidery/Stitch.
- 5 Scroll down until you see "Snowman".
- 6 Click Open to load the embroidery into the work area.
- 7 In the Category section of the Embellish window , select Decoration .
- 8 In the Embellish window  of the Control Panel , click Place Individual . The Decoration Selection dialog appears.
- 9 At the top, select the Pearl Round decoration.



Note: Place the pointer over the decorations to see the names. The other Round bead materials are Hi-Sheen, Lo-Sheen, Matt, Glass and Transparent.

10 Click Color, and in the Colors window select the Colored Pencils, then click the turquoise pencil.

11 In the Size pop-up menu, select 6.0mm.

12 In Rotation, ensure that angle is set to zero.

Note: The settings for Line are not relevant as you will place beads individually.

13 Click OK to select the turquoise round bead, and close the Decoration Selection dialog.

Note: The pointer changes to the Insert pointer $\uparrow+$ to show that you may place decorations.

14 Click in the center of the lower button on the snowman's coat. A large bead is placed for the button.

15 Click to place a bead on the top button.

Note: If you place a bead in the wrong position, Control-click and select "Undo Add single decoration" to remove the last decoration in the current sequence.

16 When you have placed the two beads, click Place Individual . The Decoration Selection dialog appears again.

17 Scroll down to the Nailhead Teardrop decorations and select Hi-Sheen Nailhead Teardrop .

18 Click Color, and in the Colors window select the Colored Pencils, then click the Moss color pencil.

19 In the Size pop-up menu, choose 4.0mm.

20 Click OK to close the Decoration Selection dialog.

21 Click to place several green teardrops on the tree, like melting snow.

22 Click Place Individual  to open the Decoration Selection dialog again.

23 Scroll up to the Sequin Snowflake decorations, and select Hi-Sheen Sequin Snowflake .

24 Click Color, and in the Colors window select the Colored Pencils, then click the Snow (white) pencil.

25 In the Size pop-up menu, select 6.0mm, and click OK to close the Decoration Selection dialog.

26 Click to place snowflakes around and above the snowman.

27 Control-click when you have placed the snowflakes and select "Finish Placing Individual" from the Context menu.

28 Click outside the embroidery and decorations. There is no selection box.

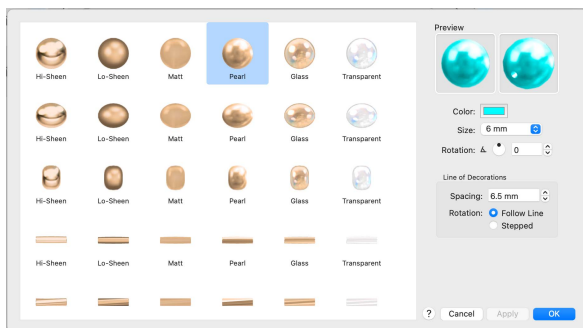

- 29 Click on the snowman. The snowman embroidery is surrounded by a box with white handles. This is the selection box for the embroidery.
- 30 Click on one of the snowflakes above the snowman.
- 31 The decorations are surrounded by their own selection box with green handles. This shows the current decoration subdesign.

Note: If you deselected Place Individual and started again, you may have two or more decoration subdesigns.

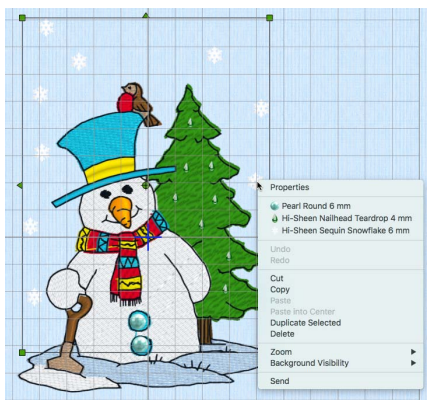

- 32 Control-click the decoration subdesign. A Context menu appears.
- 33 Select Hi-Shen Nailhead Teardrop in the Context menu.

The Decoration Selection dialog appears, with this decoration type selected.

- 34 Click the Hi-Shen Nailhead Star above the teardrop, then click OK to close the dialog.

All of the teardrops have been replaced by stars.

Note: You could also change the decorations using Edit Points and Properties, but you would have to use Command to Multiple Select the individual teardrops. The Context menu is a quick way to change all of a specific type of decoration in the subdesign.







- 35 Control-click the decoration subdesign and in the Context menu, choose "Undo Modify decoration properties". The teardrops return.
- 36 Choose File > Save and in the Save As dialog, save the snowman as Decorated Snowman.









The snowman embroidery and the decoration subdesign are saved as the .vp4 file Decorated Snowman.

Note: When you next open the file the decorations will be present.
- 37 Click Life View  to see the embroidery and decorations without a grid or hoop.

Decorated Bells

- 1 Click Hoop  in the toolbar, and in the Hoop Selection dialog select 100mm x 100mm - Universal Square Hoop 1 and click OK.
- 2 Choose File > Insert.
- 3 Browse to mySewnet/Samples/Embroidery/Stitch and select the embroidery 'Bells'.
- 4 Click Open to load the embroidery into the work area.
- 5 Click outside the embroidery so it is not selected.
- 6 In the Category section of the Embellish window , select Decoration .
- 7 Click Place Individual . The Decoration Selection dialog appears.
- 8 In the third row, select the Pearl Seed decoration.



- 9 Click Color, and in the Colors window select the Colored Pencils, then click the Cantaloupe (orange) color pencil.
- 10 Close the Colors window.
- 11 In the Size pop-up menu, select 3.0mm, and ensure that the angle is set to 0.
- 12 Click OK to select the pearl seed bead, and the Decoration Selection dialog will close.
Note: The pointer changes to the Insert pointer  to show that you may place decorations.
- 13 Click on top of the clapper in the bell on the left. A seed bead is placed over the gold clapper.
- 14 Click on the clapper for the bell on the right to place a bead there as well.
- 15 Control-click when you have placed the beads and select "Finish Placing Individual" from the Context menu.
 The two individually placed beads form a subdesign in the work area.
- 16 Click outside the subdesign.
- 17 Click Draw Freehand Line . The Decoration Selection dialog appears.
- 18 Scroll down and select the Glass Nailhead Rectangular  decoration.
- 19 Click Color, and in the Colors window select the Colored Pencils, then click the Spring (green) color pencil.
- 20 Close the Colors window.
- 21 In the Size pop-up menu, select 3.0mm.
- 22 Set Spacing in Line of Decorations to 3.0mm, and ensure that Follow Line is selected.
- 23 Click OK to close the Decoration Selection dialog. The pointer is the pen pointer .
- 24 Draw a line along the green ribbon of the bell on the left.
- 25 Click Draw Point Line . The Decoration Selection dialog appears.
- 26 You will use the same beads for the second ribbon as for the first, so click OK to close the dialog. The pointer is the Point pointer .
- 27 Click three points in a line along the green ribbon of the bell on the right, then Control-click and choose "Finish Drawing Line" to finish the line.
 Another line of green rectangular beads appears.
Note: If desired, use Edit Points  to select the ribbon lines for adjustment. See "Edit Points" on page 172.
- 28 Click outside the embroidery and decorations.
Note: This will start a new decoration subdesign.
- 29 Click the Shape pop-up menu and choose shape I, a circle, in the list.
- 30 Click Place Shape . The Decoration Selection dialog appears.

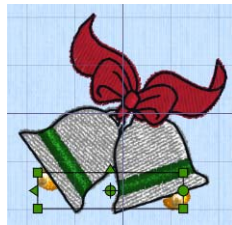

- 31 In the third row, select the Hi-Sheen Seed decoration.
- 32 Click Color, and in the Colors window select the Colored Pencils, then click the Cantaloupe (orange) color pencil. Close the Colors window.

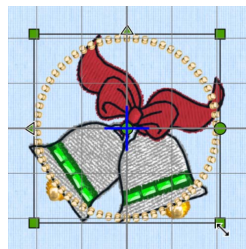

- 33 In the Size pop-up menu, select 2.0mm.
- 34 Set Spacing in Line of Decorations to 2.0mm, and ensure that Follow Line is selected.
- 35 Click OK to close the Decoration Selection dialog. The circle design is shown in a selection box with green handles.
- 36 Hold the Shift and Option keys, then drag one of the corner handles to enlarge the circle of beads proportionally and from the center so that it will fit around the design.
- 37 Move the pointer over the circle. The pointer changes to the move pointer .
- 38 Drag the circle of beads so that it fits neatly around the embroidery.

- 39 Press Command and the left arrow slowly several times. The selection boxes for the embroidery and the other decoration subdesigns are shown in turn.

- 40 With the bead circle highlighted, Control-click. The Hi-Sheen Seed beads are listed in the Context menu.
Note: The Context menu only shows the decorations within the selected subdesign.



- 41 Choose File > Save and in the Save As dialog, save the bells as Decorated Bells. The bells embroidery and the decoration subdesigns are saved as the .vp4 file Decorated Bells.
Note: When you next open the file the decorations will be present.





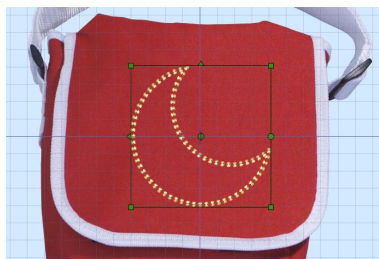

- 42 Click Life View to see the embroidery and decorations without a grid or hoop. You could display the design on a fabric with the Background Assistant. See “Background Assistant” on page 56.

Edit a Bead Crescent

Note: This exercise uses items from the full set of Backgrounds. See “Backgrounds” on page 21.

- 1 Click Hoop in the toolbar, and in the Hoop Selection dialog select 260mm x 200mm - Universal Large Hoop 3, set Orientation to Rotated, and click OK.
- 2 Click the Load Background button on the toolbar. The Background Assistant opens.
- 3 Select Load Previously Saved and click Continue.
- 4 Click the Select button.
- 5 In Garments choose Bags & Hats, Mini Reporter Bags, Mini Reporter Bag Red_Dk as your background.
- 6 Click OK, then click Done to close the Assistant.
- 7 In the Category section of the Embellish window , select Decoration .
- 8 Click the displayed shape, and select the crescent shape (31) from the pop-up menu.
- 9 Click Place Shape . The Decoration Selection dialog appears.



- 10 Scroll down and select the Hi-Sheen Seed  bead, using the Tangerine color in the Colored Pencils, 3mm in size, with a spacing of 3.5mm.
- 11 In Line of Decorations, select (check) Follow Line.
- 12 Click OK to close the Decoration Selection dialog. The crescent design is shown on the work area in a selection box with green handles.
- 13 Hold the Shift key, then drag one of the corner handles to enlarge the crescent to suit the size of the front of the bag.
Note: Hold Shift to retain the original proportions.
- 14 Move the pointer over the crescent. The pointer changes to the move pointer .
- 15 Drag the crescent to the desired position. The beads at the point at the top overlap. The design can be adjusted to prevent this.
- 16 Click Edit Points , then click the crescent. The shape is shown as a curved line with points showing the curve, and with each decoration in its own box.
- 17 Click the square point at the top of the crescent.
- 18 Drag to move this point slightly upwards. The shape becomes a line with two ends.
Note: All of the decoration shapes are closed lines (a line where the two ends are closed to form a shape).
- 19 Click Delete Points .
- 20 Move the pointer towards the point that you dragged.
Note: As the pointer approaches the point it becomes the minus pointer .
- 21 Click the point. That point, and the beads between it and the next point are removed.
Note: Use Delete Points to remove some of the points defining a line of decorations. You can use Insert Points to add points to a line.
- 22 There is still a one bead overlap. It would be better to adjust this bead than to delete the whole of the next section. Control-click and in the Context menu select "Finish Deleting Points".
- 23 Drag the end point so that the beads no longer overlap.
- 24 Click outside the shape to view the beads. There is now a gap where the two ends of the line meet.
Note: This gap could be minimized if you could change the position of the beads individually.
- 25 Click the line of beads so that it is selected.
- 26 Use Edit > Undo until you can see the original shape again.
- 27 Click Break Up Line . Every bead is now an individual decoration, forming part of a subdesign.
Note: While the whole subdesign is still selected it can be moved as one unit.

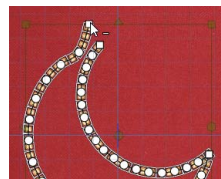
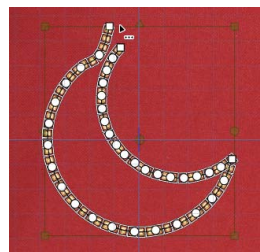









- 28 Click outside the selection box, then click one of the overlapping beads.
- Note:* The beads can now be moved or deleted independently.
- 29 Click Delete Selection . The bead is removed from the work area.
- 30 Delete and move beads until you have a smooth line.





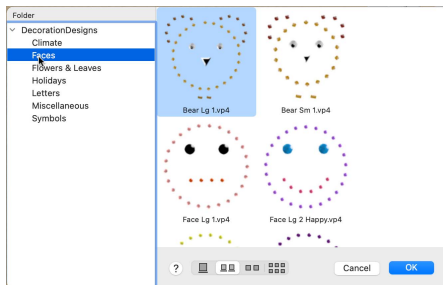

Bear on Beanie Hat

Note: This exercise uses items from the full set of Backgrounds. See “Backgrounds” on page 21.

- 1 Click Hoop , and in the Hoop Selection dialog select 260mm x 200mm - Universal Large Hoop 3, set Orientation to Rotated, and click OK.
- 2 Click the Load Background  button on the toolbar. The Background Assistant opens.
- 3 Select Load Previously Saved Background and click Continue.
- 4 Click Select, and in Garments select Bags & Hats\Beanie Hats\Medium\Beanie Hat 1 Med Gold as your background. Click Done to load the hat.
- 5 If needed, use the Zoom slider to zoom out, and use Move and Rotate Background  to drag the brim of the hat to the center of the screen.
- 6 In the Category section of the Embellish window , select Decoration .
- 7 Click Insert from Gallery , and in DecorationDesigns\Faces select Bear Lg 1.
- 8 Click OK to place the bear design in the work area.
- 9 In the toolbar, click Realistic View Mode . The bear design can be seen on the brim of the hat.
The brown crystals and sequins go well with this gold colored hat, but what if the hat was blue?
- 10 Click the Load Background  button on the toolbar and in the Background Assistant select Load Previously Saved and click Continue.
- 11 In Garments select Bags & Hats\Beanie Hat\Medium\Beanie Hat 1 Med Blue_Lt.
- 12 Use Move and Rotate Background  to drag the brim of the hat to the center of the screen.
- 13 Control-click and select Finish moving and rotating background.
- 14 Use the Zoom Slider to zoom in on the Decoration Gallery design.
- 15 Click to select, then Control-click the design. Near the top of the Context menu several decoration types are listed.



- 16 A medium brown round crystal is used for the outline of the bear's head. Choose Matt Crystal Round 3 mm at the top of the Context menu. The Decoration Selection dialog opens.
- 17 Click Color, and in the Color Pencils select the pale blue, Sky, then click OK. The outline of the bear's head is now blue.
- 18 Control-click the design again, and select Matt Crystal Rectangular 4 mm. These crystals form the bear's neck.
- 19 Change these beads to the medium blue, Aqua, in the Colored Pencils, then click OK.
- 20 Control-click again and select the dark brown Matt Crystal Round 3 mm decorations.
- 21 Change these to the deep blue, Blueberry, in the Colored Pencils, then click OK.
The colors of the other decorations will go well with the blue hat.
- 22 Zoom out to view the hat.
- 23 You can change individual elements of the Decoration Gallery design. Click 3D View .
- 24 Open the Embellish window  in the Control Panel .
- 25 Click Edit Points , then click the outline of the bear's head. This is a line of beads.
- 26 Click one of the beads in the bear's ears. These are individual beads.
Decoration Gallery designs are a single subdesign containing lines of decorations and individual decorations. Adjust decorations using Edit Points  and the Properties button or the Context menu.

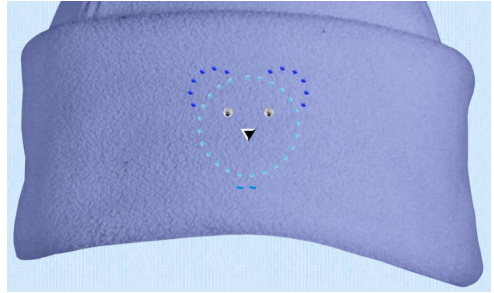

This chapter describes how you can use the appliqué features in mySewnet™ Embroidery to create, view and adjust appliqué pieces. View the appliqué fabric under your embroidery, as it appears when stitched out.

Creating Appliqué Areas

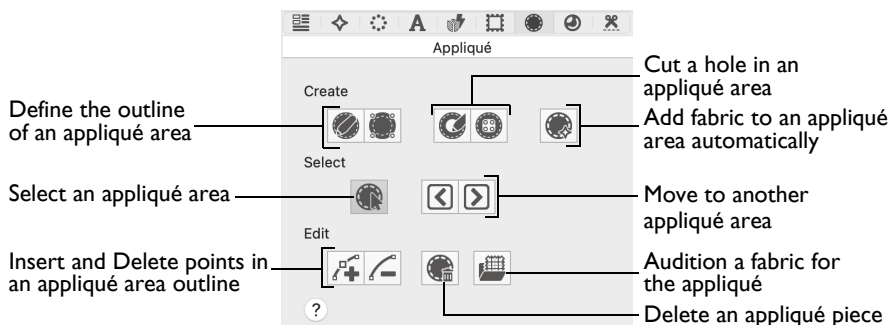

Use the Appliqué window to create and adjust appliqué pieces.

To Open the Appliqué Window

- Click Control Panel , then click Appliqué .

To learn how to	Go to
Change the fabric for an appliqué area	See “Change the Fabric in an Appliqué Embroidery” on page 185.
Create the outline for an appliqué area	See “Appliqué Outline” on page 186.
Create a hole in an appliqué area	See “Appliqué Hole” on page 187.
Add appliqué automatically to some existing embroideries	See “Express Appliqué” on page 188.
Select appliqué pieces in an embroidery	See “Select Appliqué Pieces” on page 190.
Add appliqué to an existing embroidery	See “Place Points to Add Appliqué to a Sun Embroidery” on page 191.
Select appliqué fabric	See “Appliqué Selection” on page 195.
Create a new appliqué fabric	See “Background Assistant” on page 56.
Load a Picture for appliqué	See “Load Picture Assistant” on page 198.
Select appliqué settings	See “Appliqué Options” on page 202.

View and Adjust Appliqué Pieces

Use the appliqué features to view and adjust appliqué pieces. The appliqué fabric is shown under the embroidery, as it would appear when stitched out. An unlimited number of appliqué areas may be added to the work area.

How to place appliqué

The appliqué features show how a fabric would be placed. They do not alter the stitches.

- To create new appliqué designs, or add a border, use the ExpressDesign Assistant or mySewnet™ Digitizing.
- To add extra stitches and stop commands to an existing embroidery, use the Modify window or mySewnet™ Stitch Editor.
- To place appliqué fabrics at a precise command it may be easier to navigate through the design in mySewnet™ Stitch Editor.

mySewnet™ Embroidery includes many Fonts, SuperDesigns and Frames with appliqué fabric, stitches and Stop Commands. The fabric and some stitch types may be adjusted using the Context menu.





- To change the fabric pattern position, create holes or alter the outline, you must Fix as Stitches before using the features on the Appliqué window.

Note: Any fabric background may be used as appliqué, and any number of different appliqué fabrics may be used, as desired. Ensure that the correct design is selected before adding appliqué. Use the Command and the arrow keys to step through the embroideries.

Appliqué Piece



Use the Appliqué Piece functions to add appliqué fabric to an existing design with appliqué areas, and to adjust appliqué areas within a design.

Change the Fabric in an Appliqué Embroidery

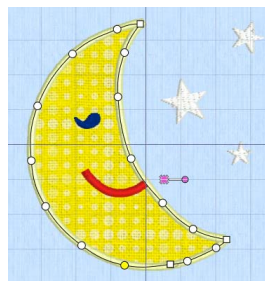
- 1 Click Hoop  in the toolbar, and in the Universal Hoop Group set the Hoop Size to 100mm x 100mm - Universal Square Hoop I. Click OK.
- 2 Choose File > New to open a new window.
- 3 Choose File > Insert.
- 4 In the Open dialog browse to the folder mySewnet/Samples/Embroidery/Stitch.
- 5 Select the embroidery 'Night Time_applique', and click Open to load it.
- 6 Open the Appliqué window  of the Control Panel .
- 7 Click Next Piece . The points for the appliqué area for the moon are highlighted.
Note: All of the appliqué functions are now available.
- 8 Drag the square zigzag fabric handle . The fabric for the moon moves.
Use the fabric handle to move the origin point (center of design) of a tiled fabric.



Note: This handle  is only available for fabric tiles; you cannot rotate quick Appliqué or Pictures.

- 9 Drag the round handle. The fabric for the moon rotates.
Note: The fabric rotates around the fabric handle (the origin point of the fabric tile).
- 10 Click Select Fabric  or choose that option in the Context menu. The Appliqué Selection dialog opens.
- 11 To change the fabric, in Appliqué Type click Fabric, then click Load Previously Saved Fabric  and in the fabric viewer choose a different fabric and click OK.
- 12 Click OK to close the Appliqué Selection dialog.

Note: If there is more than one appliqué fabric in the design, click Next Piece  to view the second fabric.



Appliqué Outline

Use the Appliqué Outline functions to draw or place points to define a line of any shape to create an appliqué outline.



Freehand Appliqué Outline

Use Freehand Appliqué Outline  to draw a line of any shape to create an appliqué outline.

To create an appliqué outline with Freehand Appliqué Outline

- Select the embroidery, then in the Appliqué window  click Freehand Appliqué Outline  and drag to draw the desired shape.



Create an appliqué outline with Freehand Appliqué Outline

- 1 Select an embroidery.
- 2 Open the Appliqué window  of the Control Panel .
- 3 Click Freehand Appliqué Outline .
- 4 Select a Color Command or Stop Command as a place to start the appliqué piece.
Note: When hovering over a Color Command you will see the stitching that follows it.
- 5 Drag to draw the outline, and release the mouse button to complete the line.
- 6 Control-click, and in the Context menu choose Finish placing appliqué. The Appliqué Selection dialog opens.
- 7 Select a fabric, then click OK to place the Appliqué Piece.
Note: Hold down Command to place a corner point when editing a line.

Point Appliqué Outline



Use Point Appliqué Outline  to place points to define a line of any shape to create an appliqué outline.

To create an appliqué outline with Point Appliqué Outline

- Select the embroidery, then in the Appliqué window  click Point Appliqué Outline  and place points to draw the desired shape.

Create an appliqué outline with Point Appliqué Outline

- 1 Select an embroidery.

- 2 Open the Appliqué window  of the Control Panel .
- 3 Click Point Appliqué Outline .
- 4 Select a Color Command or Stop Command as a place to start the appliqué piece.
Note: When hovering over a Color Command you will see the stitching that follows it.
- 5 Place points to draw the outline.
Note: Hold down Command to place a corner point when creating or editing a line.
- 6 Control-click, and in the Context menu choose Finish placing appliqué. The Appliqué Selection dialog opens.
- 7 Select a fabric, then click OK to place the Appliqué Piece.

Appliqué Hole

Use the Appliqué Hole functions to draw or place points to define a line of any shape to create a hole within the selected appliqué area. Select the desired Appliqué Piece so its points are displayed, then draw the hole.





Freehand Appliqué Hole

Use Freehand Appliqué Hole  to draw a line of any shape to create a hole within the selected appliqué area.

To create a hole in an appliqué area with Freehand Appliqué Hole

- In the Appliqué window, select an appliqué piece, click Freehand Appliqué Hole , then drag to draw a line to form the hole.

Create a hole in an appliqué area with Freehand Appliqué Hole

- 1 Select an embroidery with appliqué.
- 2 Open the Appliqué window  of the Control Panel .
- 3 Click Select Piece , and then select the desired appliqué piece so its points are displayed.
- 4 Click Freehand Appliqué Hole .
- 5 Drag to draw the outline of the desired hole, and release the mouse button to remove the fabric from the hole.
- 6 Control-click to finish creating holes.
Note: Hold down Command to place a corner point when editing a line defining a hole.



Point Appliqué Hole

Use Point Appliqué Hole  to place points to define a line of any shape to create a hole within the selected appliqué area.

To create a hole in an appliqué area with Point Appliqué Hole

- In the Appliqué window, select an appliqué piece, click Point Appliqué Hole , then place points to draw a line to form the hole.

Create a hole in an appliqué area with Point Appliqué Hole

- 1 Select an embroidery with appliqué.
- 2 Open the Appliqué window  of the Control Panel .
- 3 Click Select Piece , and then select the desired appliqué piece so its points are displayed.

- 4 Click Point Appliqué Hole .
- 5 Place points to draw the outline of the desired hole.
- 6 Control-click and choose Finish placing appliqué hole to remove the fabric from the hole.
Note: Hold down Command to place a corner point when creating or editing a line defining a hole.
- 7 Click Point Appliqué Hole again to create further holes.

Express Appliqué



Use Express Appliqué  to automatically find appliqué stitches within an existing embroidery, and apply an appliqué fabric to them. Select a fabric and optionally apply an overlap margin.

To add appliqué fabric to an existing embroidery with Express Appliqué





- In the Appliqué window, select an appliqué embroidery with no fabric, click Express Appliqué , then select a fabric in the Appliqué Selection dialog.

Add fabric to an existing appliqué embroidery with Express Appliqué



Note: This exercise uses items from the full set of Backgrounds. See “Backgrounds” on page 21.

- 1 Choose File > Open to open an existing embroidery.
- 2 Browse to the folder mySewnet/Samples/Embroidery/Stitch and load the embroidery 'Sunshine Applique Large with Lettering'.
Note: The embroidery is loaded as a multiple selection with the hoop included. If you used Insert, the initial hoop would be retained, but the embroideries are inserted as a group.
- 3 Choose File > Duplicate to open a copy of this embroidery.
Note: This ensures that you do not overwrite your original.
- 4 Click the Load Background  button on the toolbar. The Background Assistant opens.
- 5 Select Load Previously Saved and click Continue.
- 6 Click Select, and load Garments/Ladies/T-Shirts Round Neck/Medium/T-shirt | Med Green_Lt.
- 7 Use Move and Rotate Background  to move the T-shirt downwards.

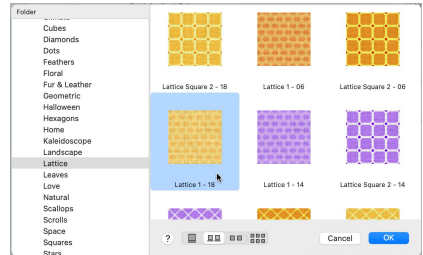
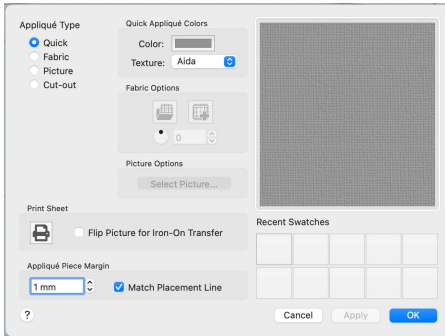

- 8 Open the Appliqué window  of the Control Panel .
- 9 Click Express Appliqué . The Appliqué Selection dialog opens so you can choose a fabric for your appliqué.
Note: Express Appliqué detects the pattern of Stop and Color Change Commands used by appliqué placement stitches and inserts appliqué fabric in that area.
- 10 In Appliqué Type, click Fabric.
- 11 Click Load Previously Saved Fabric  to load a fabric in the Viewer.



- 12 Browse to the folder General\Lattice.
- 13 Click the fabric Lattice 1 - 18, then click OK. The Viewer closes and the fabric is shown in the Appliqué Selection dialog.
- 14 Click OK to close the Appliqué Selection dialog. The fabric is shown under the sun's face, as if you had stitched it down as an appliqué.
- 15 In the toolbar, click Life View .
- 16 Move the Zoom Bar slider to the left so that you can see the t-shirt as well as the embroidery. Note that the threads for the sun's face and lettering are white.
- 17 Click Solar Reactive . The white threads turn yellow and orange.
- 18 Choose File > Save and save the embroidery with the appliqué and background as 'Sunshine Applique Large with Lettering and Background'.
Note: The sun and lettering will be stored separately within this multipart embroidery, making further adjustment easier.



Select Piece

Use Select Piece  to select an Appliqué Piece to alter its shape and preview or adjust its fabric.

To select an appliqué piece

- Select an embroidery with appliqué and in the Appliqué window click Select Piece , and then click the desired Appliqué Piece.

Next Piece

Use Next Piece  to select the next Appliqué Piece in the stitchout order.

Note: Next Piece will select an appliqué piece even if no appliqué piece is currently selected.

To select the next appliqué piece

- Select an embroidery with appliqué, and in the Appliqué window click Next Piece .

Previous Piece









Use Previous Piece  to select the previous Appliqué Piece in the stitchout order.

Note: Previous Piece will select an appliqué piece even if no appliqué piece is currently selected.

To select the previous appliqué piece

- Select an embroidery with appliqué, and in the Appliqué window click Previous Piece .

Select Appliqué Pieces

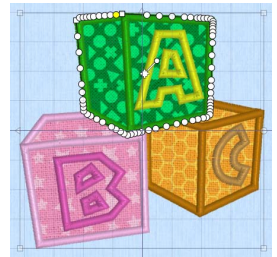

- 1 Click Hoop  in the toolbar and in the Universal Hoop Group set the Hoop Size to 100mm x 100mm - Universal Square Hoop I, then click OK.
- 2 Choose File > New to open a new window.
- 3 Choose File > Insert.
- 4 In the Open dialog browse to the folder mySewnet/Samples/Embroidery/Stitch and load the embroidery 'Blocks_fixed'.
- 5 Open the Appliqué window  of the Control Panel .
- 6 In the Appliqué window, note that the Select Piece button  is available. This indicates that there is at least one appliqué piece in the embroidery.
- 7 Click Select Piece , then click the A block. The points outlining the appliqué appear.
- 8 Drag one of the points to change the shape of the appliqué.
Note: You can change the shape of the appliqué area, but this does not affect the satin border.
- 9 Undo to return to the original shape.
Note: You can also use the Fabric Handle  to change the position and rotation of the fabric.
- 10 Click Next Piece . The letter C block is now selected.
- 11 Click Previous Piece  twice. First the A and then the B are selected.
- 12 Click Delete Piece . The appliqué fabric for the B block is removed, leaving the border lines for the brick.



Insert Points

Use Insert Points  to add new points into the currently selected Appliqué Piece.

To insert points into an appliqué piece



- In the Appliqué window, select the desired appliqué piece, then click Insert Points . With the plus pointer , click to add a point to the outline of the selected area. Control-click and choose Finish inserting points, to finish adding points to the line.

Note: Hold down Command to place a corner point.

Delete Points

Use Delete Points  to delete points from the currently selected Appliqué Piece.

To delete points from an appliqué piece

- In the Appliqué window, select the desired appliqué piece, then click Delete Points . With the minus pointer , click to remove a point from the outline of the selected area. Control-click and choose Finish deleting points, to stop removing points from the line.

Delete Piece

Use Delete Piece  to delete the currently selected Appliqué Piece with its outline.

To delete an appliqué piece

- In the Appliqué window, select the desired appliqué piece, then click Delete Piece . The appliqué piece is removed from the design.

Select Fabric

Use Select Fabric  to audition a fabric for the selected appliqué piece in the Appliqué Selection dialog.

To change the fabric for an appliqué piece

- In the Appliqué window, select the desired appliqué piece, then click Select Fabric  and change the fabric in the Appliqué Selection dialog. See “Appliqué Selection” on page 195.

Place Points to Add Appliqué to a Sun Embroidery

Note: This exercise uses items from the full set of Backgrounds. See “Backgrounds” on page 21.

- 1 Choose File > Open to open an existing embroidery.
- 2 Browse to the folder mySewnet/Samples/Embroidery/Stitch and load the embroidery 'Sunshine Applique Large with Lettering'.

Note: The embroidery is loaded as a multiple selection with the hoop included. If you used Insert, the initial hoop would be retained, but the embroideries are inserted as a group.



- 3 Choose File > Duplicate to open a copy of this embroidery.

Note: This ensures that you do not overwrite your original.

- 4 Click the Load Background  button on the toolbar. The Background Assistant opens.



- 5 Select Load Previously Saved and click Continue.
- 6 Click Select, and load Garments/Ladies/T-Shirts Round Neck/Medium/T-shirt | Med Green_Lt.
- 7 Use Move and Rotate Background  to move the T-shirt downwards.



- 8 Open the Appliqué window  of the Control Panel .
- 9 Click Zoom To Rectangle , then drag to zoom in on the sun's face.

- 10 Click Point Appliqué Outline .
Note: Appliqué is added by placing a series of points to mark the edge of the area where you want to show the appliqué fabric.

- 11 Click to select the color command  to the left of the grid line. As you hover over it, the stitches of the satin ring are highlighted. This will be a good location for the fabric.

Note: The red markers are Stop Command markers , and the blue markers are Color Change  markers.

- 12 Click to place the first point of the area at the top point of the sun's face on the sun outline. A yellow round node appears, and the pointer changes to the Point pointer .
- 13 Click to place a second point, down and to the right of the first point, following the satin line around the sun's face.

As you place points a line is drawn. Make sure that this line is on the satin line, as this marks where the edge of your appliqué will be.

- 14 Click to place a third point further around the circle. As you place more points the line adjusts itself.

Note: The line may 'swing' while you place points. Just carry on, you can adjust it afterwards. You can use Shift and click to place square nodes for straight lines.

- 15 Move the pointer over one of the nodes on the line. The pointer changes to the Move Node pointer . Adjust the node as desired.

When the Move Node pointer is active you can adjust existing nodes.

Note: If you click while the Point pointer  is active, another point will be added to the line.

- 16 Place points to complete the circle.

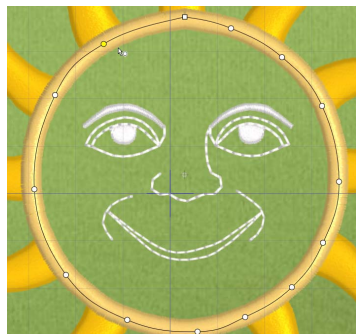

17 Control-click and choose Finish Point Line. The Appliqué Selection dialog appears, so you can choose a fabric for your appliqué.

Note: If you made a mistake while placing the appliqué line, click Cancel in the Appliqué Selection dialog without choosing a fabric and start again.

18 In Appliqué Type, click Fabric.

19 Click Load Previously Saved Fabric  to load a fabric in the Viewer.

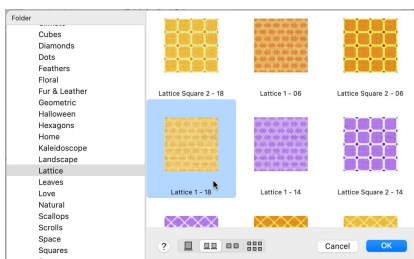
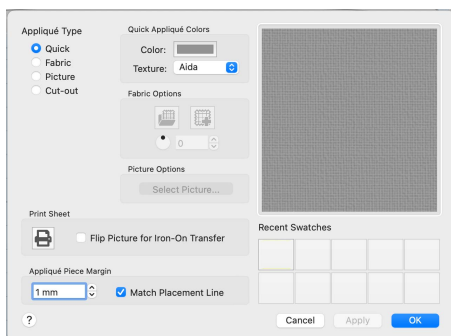

20 Browse to the folder General\Lattice.



21 Click the fabric Lattice 1 - 18, then click OK. The Viewer will close and the fabric will be shown in the Appliqué Selection dialog.

22 Click OK to close the Appliqué Selection dialog. The fabric is shown under the sun's face, as if you had stitched it down as an appliqué.

If the fabric is on top of the embroidery, the wrong command marker, or the wrong embroidery was selected. Undo the appliqué and try again.

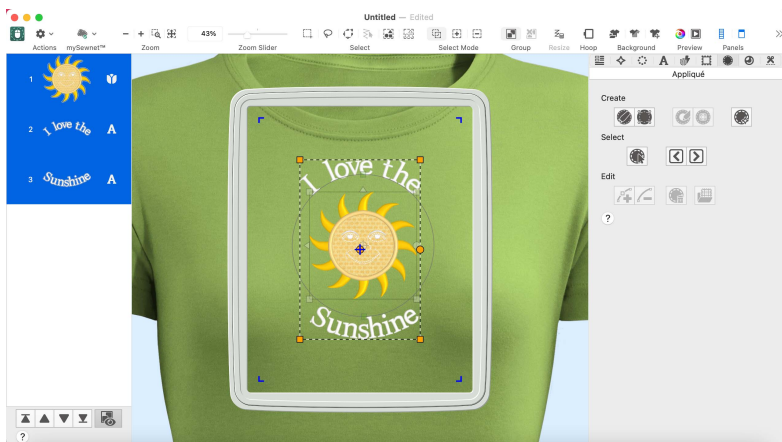
23 Click Zoom To Fit .



- 24 In the toolbar, click Life View .
- 25 Move the Zoom Bar slider to the left so that you can see the t-shirt as well as the embroidery. Note that the threads for the sun's face and lettering are white.
- 26 Click Solar Reactive . The white threads turn yellow and orange.
- 27 Choose File > Save and save the embroidery with the appliqué and background as 'Sunshine Applique Large with Lettering and Background'.



Note: The sun and lettering will be stored separately within this multipart embroidery, making further adjustment easier.

Appliqué Selection

Use the Appliqué Selection dialog to change and add appliqué fabrics.

Note: You can only change the pattern position of appliqué pieces for fixed embroideries. To change the appliqué fabric pattern position for lettering, SuperDesigns and Frames, fix as an embroidery. To change the fabric or angle only, or the appliqué piece margin, use the context menu.

Use the Appliqué Selection dialog to select a fabric or picture to use for appliqué. Click OK to use the selected appliqué fabric.

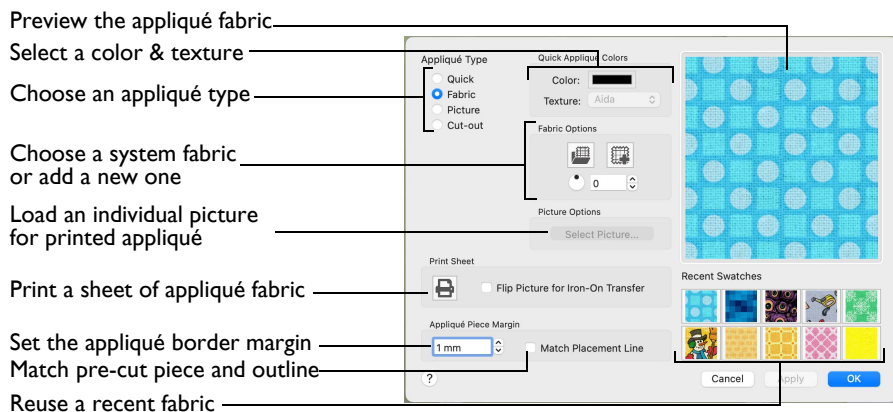

Appliqué Type

Choose an appliqué type (or simply select one of the recently used swatches). Select from:

- **Quick**
Select a color and texture for your fabric. See “Quick Appliqué Options” on page 195.
- **Fabric**
Select a background fabric, or add a new background fabric from a picture. Set the angle for the fabric. See “Fabric Options” on page 196.
- **Picture**
Create in individual non-tiling appliqué from a picture. For instance, use a photo for a printed appliqué memory piece. See “Picture Options” on page 196.
- **Cut-out**
Create an appliqué placement line as a guide to where the fabric should be cut to form a hole; for example, for reverse appliqué.

Quick Appliqué Options

Select a color and texture for your fabric.

Note: The Quick Appliqué Options are available when Quick is selected in Appliqué Type. In the mySewnet™ QuickFont Assistant only the Quick Appliqué options are available.

Color

Click the color sample to change the color in the Colors window. See “Colors Window” on page 83.

Texture

Select the texture to use for the fabric. Click on the down arrow and choose the desired fabric type.

Fabric Options

Note: The Fabric Options are available when Fabric is selected in Appliqué Type.

Load Previously Saved Fabric

Use Load Previously Saved Fabric  to load a sample fabric, or a fabric from My Fabrics, in the Background Picture Viewer. See “Background Picture Viewer” on page 197.

Add New Background Fabric

Use Add New Background Fabric  to create a new fabric background in the Background Assistant. See “Background Assistant” on page 56.

Angle

Use Angle to change the angle at which the pattern will be displayed.

Note: You may also change the angle and position of the fabric pattern directly by selecting the appliqué piece in the work area.

Enter an Angle from 0 to 359 degrees. The initial setting is 0. Alter the Angle by entering a number in the box, or use the up and down arrows to change the number. Changes in Angle are visible in the preview pane.

Print Sheet

Print a sheet of appliqué fabric from the selected Quick Appliqué or Fabric pattern. Flip the picture for an iron-on transfer, and select a printer and paper size in the Print dialog. See “Print” on page 517.

Picture Options

Note: The Picture Options are available when Picture is selected in Appliqué Type.

Click Select Picture to create a picture background in the Load Picture Assistant. See “Load Picture Assistant” on page 198.

Fabric Preview

The chosen fabric is previewed on the right.

Recent Swatches

Select a recently used fabric to use again.

Appliqué Piece Margin

Set the margin for appliqué placement relative to the drawn border shape from -10mm to 10mm. The initial value is 1.0mm.

Use a positive value when trimming the appliqué fabric before the border is stitched, for example with Standard Appliqué and Pre-placed Appliqué. A negative value is recommended for cut-out and reverse appliqué.

Note: Appliqué Piece Margin is only available when adjusting appliqué lettering, SuperDesigns and Frames using the Stitch Types options or context menu.

Use the Appliqué Piece Margin and Match Placement Line settings in Preferences to override the initial appliqué placement settings for lettering, SuperDesigns, Frames and Flourishes. See “Appliqué Piece Margin” on page 516.

Match Placement Line

Adjust the position of the first running stitch line for either Standard Appliqué or Pre-cut Piece so that it matches the outline of the appliqué piece after the Appliqué Piece Margin has been applied.

Note: This may be useful for precise positioning of appliqué pieces that have been pre-cut with an automated cutter, to ensure the placement line is visible.

Background Picture Viewer

Use the Picture Viewer to select a fabric from the system fabrics, or from the My Fabrics folder with fabric backgrounds you have added.

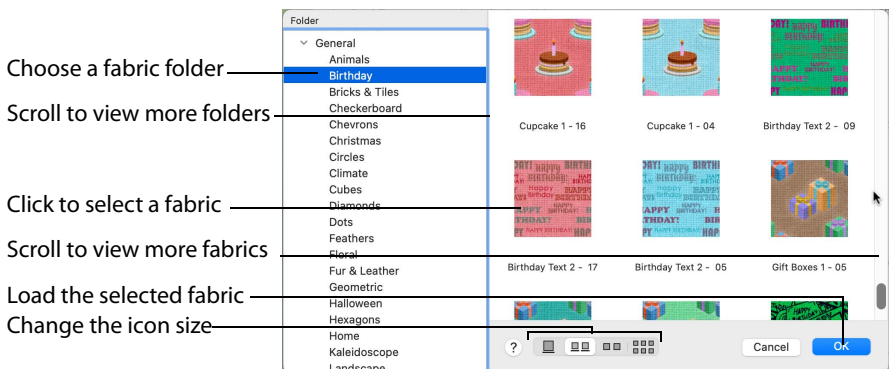

- To open the Picture Viewer, in the Appliqué Selection dialog select Fabric, then click Load Previously Saved Fabric .
- Open a folder, and scroll down and click a fabric to select it. Click OK to load the fabric in the Appliqué Selection dialog.

- To create a new fabric in the Background Assistant, in the Appliqué Selection dialog select Fabric, then click Add New Background Fabric . See “Background Assistant” on page 56.

Load Picture Assistant

Use the Load Picture Assistant to use a picture as an individual non-tiled appliqué background, for example for a printed appliqué memory piece.

Choose Picture

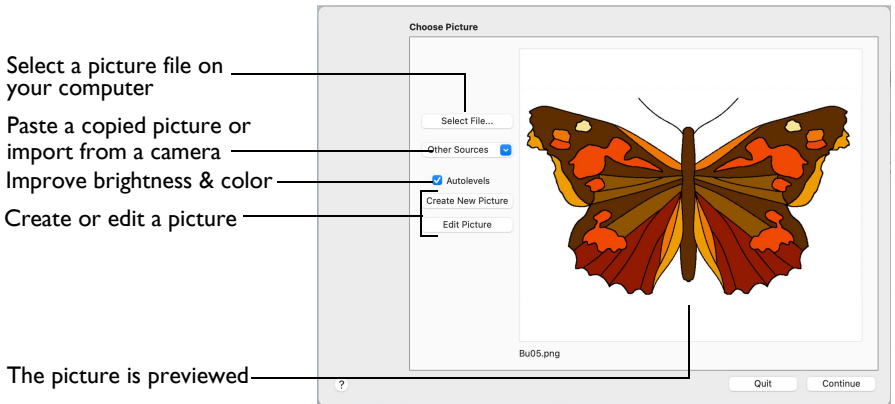

Use the Choose Picture page to select the picture you wish to use as a background.

After selecting a picture, the preview box shows the selected picture with its name underneath.

Select File

- Click Select File to open a picture from one of the Samples subfolders, such as: mySewnet/Samples/Embroidery/Pics. Alternatively, browse to a folder elsewhere on your computer.

Note: Click Show as Icons  to view thumbnails of the pictures.

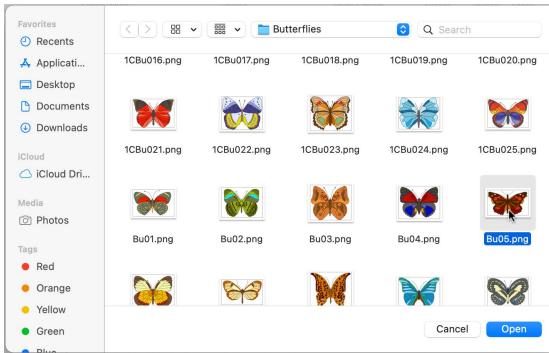

The following file formats may be loaded: Windows or OS2 Bitmap (.bmp), JPEG-JFIF Compliant (.jpg, .jif, .jpeg), PatternCAD (.4dq), Portable Network Graphics (.png), Tagged Image File Format uncompressed (.tiff, .tif), Windows Meta File (.wmf), Windows Enhanced Meta File (.emf) and Windows Icon (.ico), High Efficiency Image Format (.heic).

Select a Picture

- 1 Click Select File. The Open dialog appears.
- 2 Browse to the desired folder, for example mySewnet/Samples/Embroidery/Pics.
- 3 Click on a picture.
- 4 Click Open to open the picture onto the Choose Picture page, and to close the dialog. Click the Cancel to exit without selecting a picture.

Other Sources

Paste

- Paste an image from the Clipboard.

Services

Use Services to import a picture.

- **Camera:** Import a picture from an integrated MacBook® camera.
- **Capture Full Screen:** make a screenshot of the whole screen.
- **Capture Selection from Screen:** make a screenshot of part of the screen.
- **Import Image:** import a picture from a camera or scanner connected to the computer.

Autolevels

Use Autolevels to improve the brightness and contrast in most photos. It can also be used to bring out the color in underexposed pictures.

By default Autolevels is enabled.

Note: Occasionally Autolevels does not improve the appearance of a picture, and may need to be switched off.

Create New Picture and Edit Picture

Create a new picture or edit an existing picture in mySewnet™ Draw & Paint.

Continue

Go to the Rotate and Crop Picture page.

Rotate and Crop Picture

Correct the perspective in the picture

Select the whole picture

Change the picture angle

Automatically exclude
the picture background

Adjust the crop lines
as desired

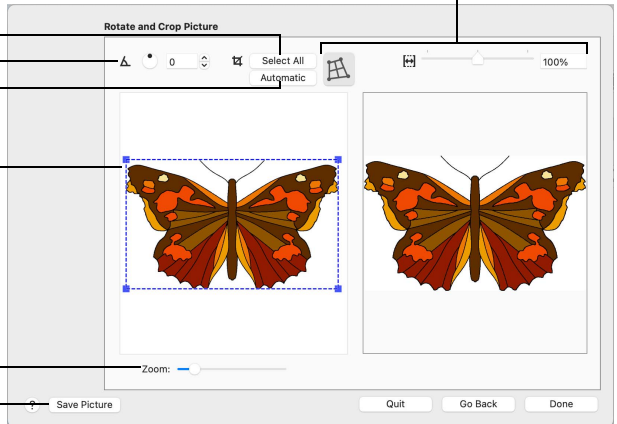

Zoom in and out

Save the edited picture

If required, rotate the picture to any angle from 0 to 359 degrees. For example, this is useful for straightening scanned pictures. Use Crop to select the section of the picture that is to be used to create the appliqué background.

When the picture is rotated between the 90 degree steps, the picture is made larger and the detected background color is added. If there is no distinctive background color, white is used.

Note: The size of the crop box may vary if the picture is rotated.

Select All: Select the whole of the picture.

Automatic: Select the smallest rectangle that includes all colors that are not the background color.

Note: Sometimes the automatic crop area may not appear to remove as much background as possible. This can happen when the background color appears to be a plain color such as white, but actually has minor variations that are not immediately visible. For example, this often happens with the JPEG-JFIF Compliant (*.jpg, .jif, .jpeg) picture format.

Rotate and Crop a Picture

1 Drag the rotational slider to rotate the picture to the desired angle.

Alternatively, enter a number in the rotation angle number box, or use the arrows to increase or decrease the angle of rotation.

- 2 Drag the handles on the crop area boundary line to select the desired part of the picture. Hold the Shift key while dragging to resize the rectangle proportionally. Hold the Option key while dragging to resize the rectangle without moving its center.
- 3 Drag anywhere inside the crop box to move the crop box.
Note: If you need to expand a crop box again, make sure it is not touching the edge of the frame, as this will stop it expanding.
- 4 If desired, click Automatic to select the crop lines automatically, or click Select All to use the whole of the picture.

Perspective Correction

To remove the effects of perspective in a picture, or to correct skew, select Perspective Correction . When using Perspective Correction, the crop handles are red.

Drag the red handles so that the crop lines frame the picture. Use the Zoom tools to view the outline of the picture more clearly. Drag the Stretch Picture  slider to make the picture in the Preview wider or narrower. Use Save Picture to save your edited picture.

Zoom

Use the Zoom bar to change the view of the picture. Zoom in (drag the slider to the right) to magnify the view. Zoom out (drag the slider to the left) to shrink the view.

When zoomed in, use the scroll bars or swipe to move around.

Go Back

Return to the Choose Picture page.

Done

Use the selected image for the appliqué

Export Appliqué

Use Export Appliqué Pieces in the File menu to save or print appliqué outlines ready for cutting.

There are five export methods: save as SVG, DXF or FCM files for use in fabric cutters, save as VP4 or VP3 stitch files for use with INSPIRA™ Cutwork Needles, print as an outline template to cut around, print directly onto printable fabric or an iron-on transfer (this prints the image of the appliqué piece), or save as SVG files with the fabric image placed as the fill for each shape (for use with fully customized layouts). See “Export Appliqué Pieces” on page 39 for more information.

Appliqué Options

Use the Appliqué Options dialog to select an Appliqué Method for appliqué placement, and set the Appliqué Piece Margin, the Running Stitch Length, and the Double Stitch Length.

Appliqué Placement

When appliqué is created from a border shape, additional stitches are added at the beginning of the embroidery for placing appliqué fabric. Use these options to determine how these stitches are added. The border used to finish the appliqué uses line options for the selected border stitch type.

Appliqué Method

Choose the method for placing and securing the appliqué fabric.

- **Standard Appliqué**
Stitch a running line to show where appliqué fabric should be placed, then stop to position the fabric. Stitch down the appliqué fabric with double stitch, then stop so the fabric may be trimmed. Finish the edges with the selected border stitching.
- **Pre-cut Piece**
Use a pre-cut appliqué piece; created, for example, using an automatic cutter or cutwork needles.

Stitch a running line to show where the pre-cut appliqué piece should be placed, then stop to position the appliqué piece. Stitch down the appliqué piece with double stitch, then finish the edges with the selected border stitching.
- **Pre-placed Piece**
Place the appliqué fabric before stitching.

Place the appliqué layer in position, then stitch down the appliqué fabric with double stitch. Stop so the fabric may be trimmed. Finish the edges with the selected border stitching.
- **Cut-out**
Use the appliqué placement line as a guide to where the fabric should be cut; for example for reverse appliqué.

Stitch a double stitch line. Stop so the fabric may be cut to form a hole defined by the stitched outline. Finish the edges with the selected border stitching.

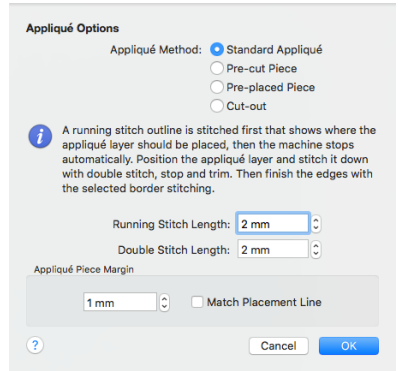

Running Stitch Length

Set the length of running stitch used for the placement outline in the first and second appliqué methods, from 1 to 12mm in 0.1mm steps. The initial setting is 2.0mm.

Note: If you position the arrow pointer over the box without clicking, the alternative units and range will be shown.

Double Stitch Length

Set the length of double stitch used to stitch down the appliqué fabric, from 1 to 12mm in 0.1mm steps. The initial setting is 2.0mm.

Note: If you position the arrow pointer over the box without clicking, the alternative units and range will be shown.

Appliqué Piece Margin

Set the margin for appliqué placement relative to the drawn border shape from -10mm to 10mm. The initial value is 1.0mm.

Note: Use a positive value when trimming the appliqué fabric before the border is stitched, for example with Standard Appliqué and Pre-placed Appliqué. A negative value is recommended for cut-out and reverse appliqué.

Match Placement Line

Adjust the position of the first running stitch line for either Standard Appliqué or Pre-cut Piece so that it matches the outline of the appliqué piece after the Appliqué Piece Margin has been applied.

Note: This may be useful for precise positioning of appliqué pieces that have been pre-cut with an automated cutter, to ensure the placement line is visible.

ExpressDesign Assistant



Use the ExpressDesign Assistant to create new embroideries automatically from pictures.

Create an embroidery automatically from a picture with the ExpressDesign Assistant . There are three embroidery types that can be created in the ExpressDesign Assistant: Express Embroidery, Express Trace and Express Border.

Express Embroidery



Express Trace

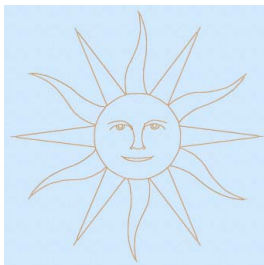

Express Border

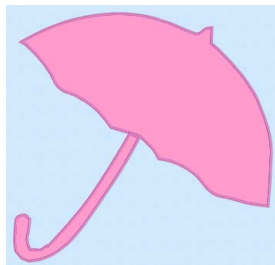

Convert color areas in a picture to fill and satin areas, outlining it with running stitch or satin line.

Trace outlines in a picture.

Create a border around shapes in a picture.

Express Embroidery: Create a new embroidery by converting color areas in a picture to fill and satin areas, using running stitch or satin border outlines where necessary.

Express Embroidery works best when using pictures that have well defined, flat color areas and outlines.

Express Trace: Create a new embroidery by tracing outlines in the picture. Use double trace or quadruple trace to create redwork or blackwork style embroidery, create quilt stencils and so on. Use satin line trace for larger designs, or when a bolder outline is more pleasing.

Express Border: Create a new embroidery by creating borders around shapes in a picture. The border can be created as a satin line, appliqué, an outline of running, double or triple stitch, or a motif line.

To learn how to	Go to
Create a full color Express Embroidery	See “Create a Happy Sun Embroidery” on page 234.
Create a Express Trace embroidery	See “Create a Happy Sun Express Trace” on page 236.

To learn how to	Go to
Create a Express Border embroidery	See “Create an Umbrella Border” on page 237.

- In mySewnet™ Embroidery, when the new embroidery is saved it is included in the project with any other designs that are on the screen.
- In mySewnet™ Digitizing, the embroidery design is included in the .edo file with any other parts of the design that have been created later.

Create an Embroidery with the ExpressDesign Assistant



- 1 Start the ExpressDesign Assistant.
 - To create an embroidery that is a best-fit to the currently selected hoop, choose Assistants > ExpressDesign > ExpressDesign into Hoop.
 - To create an embroidery that is a best-fit to a rectangular area you drag on the mySewnet™ Embroidery screen, choose Assistants > ExpressDesign > ExpressDesign into Rectangle.
- 2 In the Select ExpressDesign Method page, select the desired design type from: Express Embroidery, Express Trace, or Express Border, then click Continue.
- 3 Select a picture in the Choose Picture page.
- 4 Step through the rest of the ExpressDesign Assistant.
- 5 When you click Done at the end of the assistant, the new embroidery is placed to fit in the center of the hoop, or where you drew the rectangle.
- 6 Choose File > Save (or press ⌘S) to save the new embroidery in multipart .vp4 format.
- 7 Choose File > Export (or press ⌘⇧S) to save the embroidery in a format optimized for sewing.

ExpressDesign into Hoop





Use the ExpressDesign into Hoop  option to create a new embroidery in the ExpressDesign Assistant that is a best-fit to the currently selected hoop.

Depending on the shape of the embroidery design, it will fit in the hoop vertically and/or horizontally.

Create a design to fit the hoop

- In the Create window  of the Control Panel  click ExpressDesign  > ExpressDesign into Hoop.
- Choose Assistants > ExpressDesign > ExpressDesign into Hoop.

Use ExpressDesign into Hoop

- 1 If desired, click Hoop  and choose a different hoop size before using ExpressDesign into Hoop.
- 2 In the Create window  of the Control Panel  click ExpressDesign  > ExpressDesign into Hoop. Alternatively, choose Assistants > ExpressDesign > ExpressDesign into Hoop.
- 3 Select the desired design type.
- 4 Select a picture to use for the embroidery design.
- 5 Step through the rest of the ExpressDesign Assistant.



When you finish, the new embroidery design is in the center of the hoop.

- 6 Use Save, then Export to keep the new embroidery.





ExpressDesign into Rectangle

Use the ExpressDesign into Rectangle option to create a new embroidery design in the ExpressDesign Assistant that is a best-fit to a rectangular area you draw on the screen.

Create a design to fit a rectangle

- In the Create window  of the Control Panel  click ExpressDesign  > ExpressDesign into Rectangle.
- Choose Assistants > ExpressDesign > ExpressDesign into Rectangle.

Use ExpressDesign into Rectangle

- 1 In the Create window  of the Control Panel  click ExpressDesign  > ExpressDesign into Rectangle. The mouse pointer changes to the draw rectangle pointer .
- 2 Drag to draw a rectangle of the desired size on the work area. When you release the mouse button, the Choose Picture page of the ExpressDesign Assistant appears. If the rectangle is wrong and you wish to try again, click Cancel when the ExpressDesign Assistant appears. Then click ExpressDesign into Rectangle again.
- 3 Select the desired design type.
- 4 Choose a picture.
- 5 Step through the rest of the ExpressDesign Assistant. When you finish, the new embroidery is placed where you drew the rectangle, and will fit the rectangle proportionally, depending on the picture shape.
- 6 Use Save, then Export to keep the new embroidery.

Choosing and Optimizing Pictures for the ExpressDesign Assistant

If you wish to modify a picture before using it in the ExpressDesign Assistant, you will need to use a picture editor such as Preview. Adjust your picture, save it with a new name, then use the new picture in the ExpressDesign Assistant.

Note: It is recommended to keep your original picture in case you wish to adjust it again with different options.

General Considerations

The ExpressDesign Assistant works best with pictures that have well defined color areas and outlines.

You may wish to tidy up a picture before using it in the ExpressDesign Assistant, by deleting elements that are not required. Some pictures have stray or irregular lines and shapes that are not part of the main picture. For example, lines that add

emphasis or suggest movement, speech or thought bubbles, decorative symbols, unwanted text, and so on.

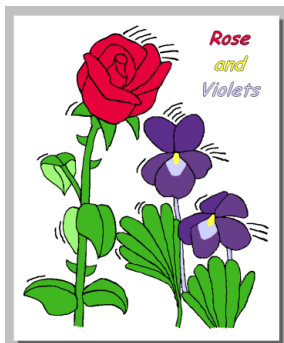

Before tidying: there are sections of text and emphasis lines in the picture

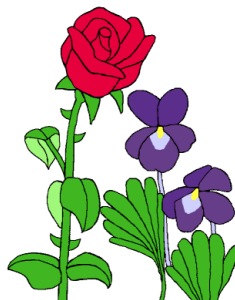

After tidying: the essential part of the picture is retained

Note: In the example, the border was removed. This rough crop leaves white space around the edges of this picture which can be automatically removed in the Rotate and Crop Picture page, or as the background color in the Choose Thread Colors page of the ExpressDesign Assistant.

Picture Proportions

To fill the hoop or rectangle, the picture proportions should be similar to the proportions of the hoop or rectangle you draw. The Rotate and Crop Picture page of the ExpressDesign Assistant can be used to crop the picture to the desired proportions.

Cleaning a Picture

Some pictures may have random marks, speckles or excess details. If desired, use an image editor to clean up your picture before importing it. For example, you may have an outline in a picture that is serrated on one side. Smoothing such an outline will usually give better results, particularly from Express Trace and Express Border.



Before cleaning: the line has shading serrations and there are dust marks from the scan



After cleaning: the line is smooth and the dust marks have been removed

Enhancing Details

The significance of details in a picture is dependant on the overall size of the picture after it is cropped, so small details are more significant in a small picture. Also, small details are enlarged as the size of the created embroidery increases, so extra detail may appear if you simply make a larger embroidery with the same picture.

However, very small details in a picture may sometimes be ignored, as they may not have enough significance to be created as an area or outline in the embroidery. To enhance details, select Picture Options in the Choose Thread Colors page of the ExpressDesign Assistant, ensure Expand Pixel-Thin Lines is selected and set the Area Sensitivity to High. If this does not work, either enlarge the details in your picture editor, or, for outline details, connect small details together so they are created as a single outline.

Thick lines in a picture may be created as satin line when you would prefer regular outlining for a more detailed effect. To automatically reduce thick outlines, select Reduce Thick Lines in the Picture Options.

Patching Gaps in Pictures

Some pictures may have unwanted gaps in outlines that are too small to pick out easily. Outlining with the ExpressDesign Assistant may therefore not work as desired. If you suspect your picture may have gaps, you can test your picture with flood fill in mySewnet™ Draw & Paint, or Instant Alpha selection in Preview, then patch up any gaps that are found.

Pictures for ExpressDesign

Many types of picture are suitable for the ExpressDesign Assistant. The primary factor, however, is to use pictures with well defined color areas and/or well defined outlines. Pictures that have complex color areas, such as photographs or scanned pictures that have not been cleaned up, can be used with the ExpressDesign Assistant, but you may not get the best result unless some time is spent modifying the original picture.

Pictures for Express Trace

Pictures are converted to black and white using the Monochrome Threshold to create a black and white line drawing that can be traced using only one color. If there are large solid areas that cannot be removed with the Monochrome Threshold, edit the picture before loading it to remove the solid areas.

If a picture does not have its own outlines, use Find Outline on the Outline Finder and Expander page. This works best with clearly defined color areas with sharp edges.

Note: Pictures with gradual color changes, such as photographs or previously scanned pictures saved in JPEG format, may not have strong color boundaries that can be detected by Find Outline.

Connected Outlines

When editing or creating a picture, check how the outlines are connected to each other and, where possible, look for unobtrusive places to connect outlines. When the outlines are more connected, there are fewer movement stitches in the final embroidery and the embroidery will also stitch out more efficiently. Also, for smaller embroideries, adding connections between outlines is less noticeable and prevents small sections of stitches that might be less secure.

Pictures for Express Border

Express Border uses Monochrome Threshold to separate shapes from the background, leaving black shapes on a white background. A border is placed around any solid or fully enclosed shapes within the picture. If there are shapes within the shapes, the inner shapes are ignored.

Pictures with Dark Borders and Backgrounds

If a picture has a black or very dark border or background, a rectangular border may be created around the edge of the picture, rather than around the desired image. It may not be possible to remove this unwanted border with Monochrome Threshold.

For pictures with a dark border, you could remove the border on the Crop Picture page of the ExpressDesign Assistant. Alternatively, edit the picture to remove the border or change the border color.

For pictures on a dark background, use a picture editor to invert the colors in the picture or change the background color to a light color.

After editing the picture, load it again in the ExpressDesign Assistant.

Stippled Pictures

Stippled pictures are not suitable for use in the ExpressDesign Assistant. This is because the color areas approximate solid colors with dots of two or more colors in a stipple pattern.

Stippled pictures may be used for Express Trace or Express Border if they have solid outlines, or areas that can be extracted using Monochrome Threshold.

Choose Design Type

Convert color areas to satin and fill

Trace picture outlines

Create borders around shapes in a picture

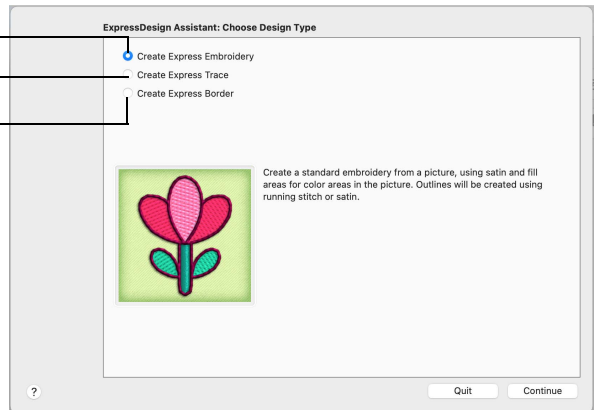

Use the Select ExpressDesign Method page to create a colored embroidery, trace an outline, or create a border from a picture.

Express Embroidery



Create a standard embroidery using satin, fill areas and outlining.

Express Trace

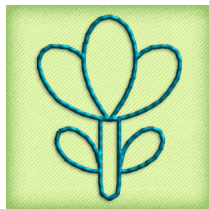

Trace outlines in a picture to create, for example, redwork, quilt stencils and so on.

Express Border

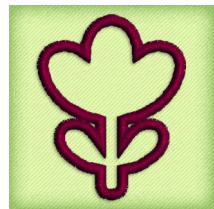

Create satin line, appliqué, running stitch, triple stitch or motifs around the edges of solid color areas in the picture.

Express Embroidery

Create a new design by converting color areas in a picture to fill and satin areas, using running stitch or satin border outlines where necessary.

Express Trace

Create a new design by tracing outlines in the picture. Use double trace or quadruple trace to create redwork or blackwork style embroidery, create quilt stencils and so on. Use satin line trace for larger designs or when a bolder outline is more pleasing.

Express Border

Create a new design by simplifying a picture into solid color areas. Borders are created around these shapes as satin, appliqué, running stitch, double stitch, triple stitch or motifs.

Continue

Go to the Choose Picture page.

Choose Picture

Select a picture file on your computer

Paste a copied picture or import a file from a scanner or camera

Create or edit in Draw & Paint

The picture is previewed

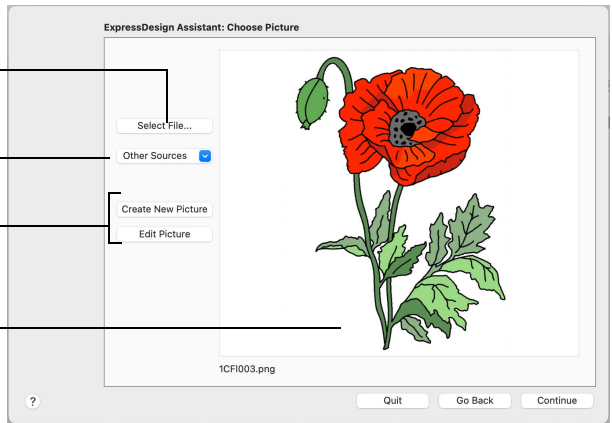

Use the Choose Picture page to select the picture you wish to convert to a design. Select a picture from clipart, or one you have previously scanned or created in an image editor. Alternatively, paste a captured picture.

Select File

- Click Select File to open one of the Samples subfolders such as: mySewnet/Samples/Embroidery/Pics. Alternatively, browse to a folder elsewhere on your computer.

Note: Click Show as Icons  to view thumbnails of the pictures.

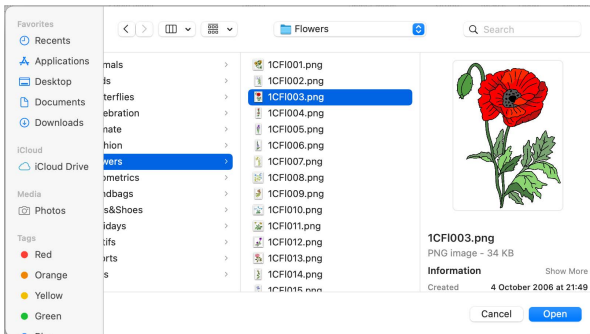

The following popular file formats may be loaded: Bitmap (.bmp), Encapsulated PostScript (.epi, .eps), Graphics Interchange Format (.gif), JPEG-JFIF Compliant (.jpg, .jif, .jpeg), JPEG 2000 (.jp2, .jpf), JPEG Multi-Picture Object (.mpo), Photoshop (.psd), Portable Document Format (.pdf), Portable Network Graphics (.png), Postscript (.ps), Tagged Image File Format uncompressed (.tiff, .tif), Camera RAW (.raw & many others), High Dynamic Range (.exr, hdr), High Efficiency Image Format (.heic).

These additional formats can also be loaded: Apple Icon (.icns), Fax (.fax & many others), Linux Icon (.xbm), Macintosh Picture (.pct, .pic, .pict), MacPaint (.mac, .pnt, .pntg), Microsoft Icon (.cur, .ico), Silicon Graphics (.rgb, .sgi) and Truevision TGA (.targa, tga).

Select a Picture File

- 1 Click the Select File button and the Open dialog appears.
- 2 Browse to the desired folder, for example mySewnet/Samples/Embroidery/Pics.
- 3 Click on a picture.
- 4 Click Open to use the picture in the Choose Picture page.
Click Cancel to exit without selecting a picture.

Other Sources

Paste

- Paste an image from the Clipboard.

Services

Use Services to import a picture.

- **Camera:** Import a picture from an integrated MacBook® camera.
- **Capture Full Screen:** make a screenshot of the whole screen.
- **Capture Selection from Screen:** make a screenshot of part of the screen.
- **Import Image:** import a picture from a camera or scanner connected to the computer.

Create New Picture and Edit Picture

Create a new picture or edit an existing picture in mySewnet™ Draw & Paint.

Go Back

Return to the Select ExpressDesign Method page.

Continue

Go to the Rotate and Crop Picture page.

Rotate and Crop Picture

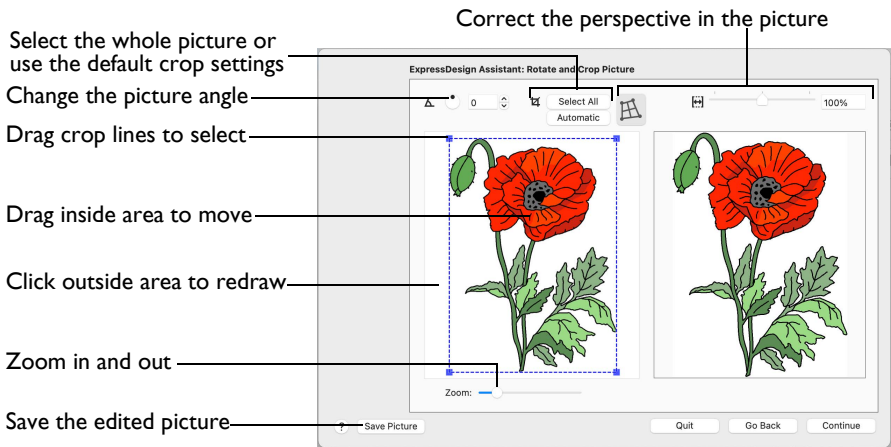

If required, rotate the picture to any angle from 0 to 359 degrees. For example, this is useful for straightening scanned pictures. Use Crop to select the section of the picture that is to be used.

When the picture is rotated between the 90 degree steps, the picture is made larger and the detected background color is added. If there is no distinctive background color, white is used.

Note: The size of the crop box may vary if the picture is rotated.

Select All: Select the whole of the picture.

Automatic: Select the smallest rectangle that includes all colors that are not the background color.

Note: Sometimes the automatic crop area may not appear to remove as much background as possible. This can happen when the background color appears to be a plain color such as white, but actually has minor variations that are not immediately visible. For example, this often happens with the JPEG-JFIF Compliant (*.jpg, .jif, .jpeg) picture format.

Rotate and Crop a Picture

- 1 Drag the rotational slider to rotate the picture to the desired angle. Alternatively, enter a number in the rotation angle number box, or use the arrows to increase or decrease the angle of rotation.
- 2 Drag the handles on the crop area boundary line to select the desired part of the picture. Hold the Shift key while dragging to resize the rectangle proportionally. Hold the Option key while dragging to resize the rectangle without moving its center.
- 3 Drag anywhere inside the crop box to move the crop box.

Note: If you need to expand a crop box again, make sure it is not touching the edge of the frame, as this will stop it expanding.

- 4 If desired, click Automatic to select the crop lines automatically, or click Select All to use the whole of the picture.

Perspective Correction

To remove the effects of perspective in a picture, or to correct skew, select Perspective Correction . When using Perspective Correction, the crop handles are red.

Drag the red handles so that the crop lines frame the picture. Use the Zoom tools to view the outline of the picture more clearly. Drag the Stretch Picture  slider to make the picture in the Preview wider or narrower. Use Save Picture to save your edited picture.

Zoom

Use the Zoom bar to change the view of the picture. Zoom in (drag the slider to the right) to magnify the view. Zoom out (drag the slider to the left) to shrink the view.

When zoomed in, use the scroll bars or swipe to move around.

Go Back

Return to the Choose Picture page.

Continue

Go to the Design Size page.

Design Size

Set the size of the design

Zoom in and out on the design

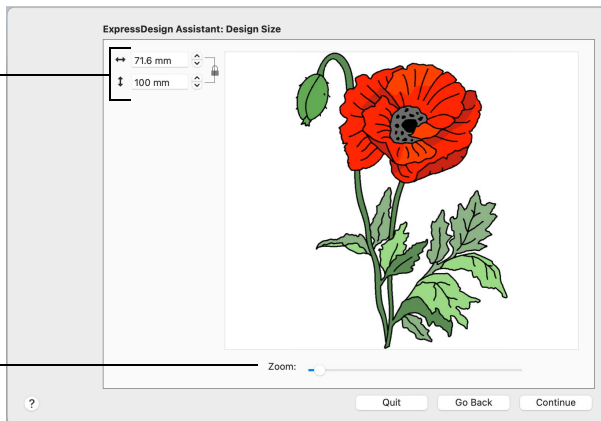

Use the Design Size page to adjust the size for the embroidery from the original hoop size or rectangle.

The lock indicator shows that the original proportions of the rectangle or hoop cannot be changed.

Set the Design Size

- Click the Size up and down arrows or enter a number to change the design size.

Zoom

Use the Zoom bar to change the view of the picture. Zoom in (drag the slider to the right) to magnify the view. Zoom out (drag the slider to the left) to shrink the view.

When zoomed in, use the scroll bars or swipe to move around.

Go Back

Return to the Rotate and Crop Picture page.

Continue

Go to the Choose Thread Colors page.

Choose Thread Colors

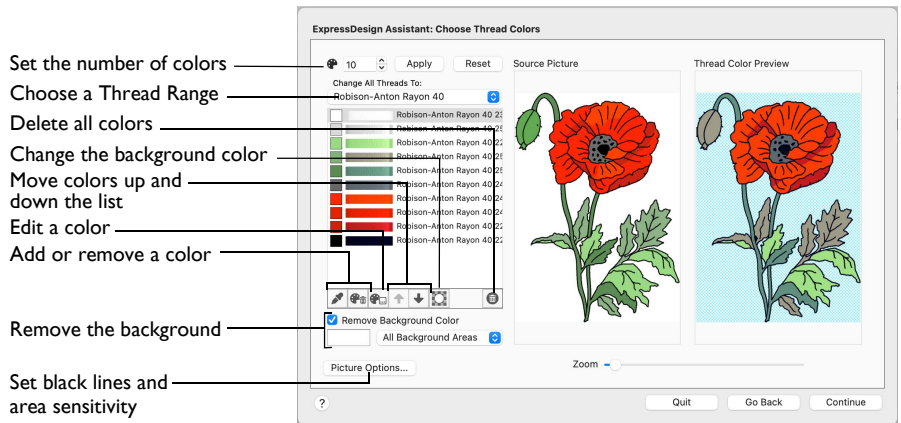

Use the Choose Thread Colors page to match thread colors to colors in the picture and choose the color order. Select whether or not to keep the background and, if desired, pick a different background color. Optionally, choose whether or not to expand thin lines and set the sensitivity to small areas in the picture.

Color Selection

Number of Colors : Set the number of thread colors used in the embroidery. The number of colors is initially set to the recommended number for the picture. The maximum Number of Colors is 256.

- Click the Number of Colors up and down arrows or enter a number to change the number of colors.

Apply: Update the list of threads and the thread color preview.

Reset: Return the thread list to the initial (recommended) set of threads.

Note: When Reset is used, any custom thread matches that were made must be re-selected with Edit Selected Color.

Change All Threads To

Change the thread range. When a thread range is chosen, each color in the picture is assigned the nearest matching thread color from the chosen thread range.

- Choose a thread range from the pop-up menu.

Note: When a new thread range is chosen, all custom thread matches set by Edit Selected Color are lost.

Thread Color List

The list shows a thread color for each color currently selected from the picture. The color order can be changed. This affects the order that threads are used in the final design.

Note: The basic color order is set by this list. However, the order for stitch types is satin, then fill, then outlines (running stitch or satin). Hence, if black is moved so that it is first in this list, it will still be last in the final design if it is only used for outlining.

The same thread color may be matched to two or more colors in the picture. Each thread color can be individually changed with Edit Selected Color. When thread colors are changed in the list, the Thread Color Preview is updated.

Note: When more than one color in the picture is matched to the same thread color, the number of color changes in the final embroidery is reduced.



Change Colors

Pick New Colors

Use Pick New Colors  to add thread colors to the list by selecting them from the source picture.

Note: The thread color is picked for the clicked color according to the RGB (red, green, blue) value at the point clicked. If there is already a thread color assigned to that exact RGB value, it is highlighted in the list instead of adding a thread color to the list.

Pick a New Thread Color

- 1 Click Pick New Colors .
- 2 Move the pointer over the Source Picture. The pointer changes to an eye-dropper .
- 3 Click the picture to pick up the color under the tip of the eye-dropper.
The nearest matching thread color from the selected Thread Range is automatically selected and added to the thread color list, and the Thread Color Preview is updated to show any other areas that can use the selected thread color.

Delete Selected Color

Use Delete Selected Color  to remove the highlighted color from the list.

The deleted color is replaced with the nearest remaining picture color in the list. The Thread Color Preview is re-displayed, with the reduced set of thread colors.



Edit Selected Color

Use Edit Selected Color  to change a thread color.

Note: It is recommended only to use Edit Selected Color after the main thread range has been selected.

- Click a color in the list, then click Edit Selected Color. The Color Selection dialog appears so that a different thread color can be chosen. See “Color Selection Dialog” on page 79.

Move Earlier and Move Later

Use Move Color Earlier in the Stitch Order  and Move Color Later in the Stitch Order  to change the order of colors in the list.

- Click Move Color Earlier in the Stitch Order to move the color up the list, and stitch it out earlier in the embroidery.
- Click Move Color Later in the Stitch Order to move the color down the list, and stitch it out later in the embroidery.

Delete All Colors

Use Delete All Colors  to remove all the thread colors from the list.

Note: Delete All Colors can be used to clear all colors before using Pick New Colors to choose colors from the Source Picture.

Background Color

The background color is automatically determined. It is the color which is used the most along the edges of the picture. You can select a different background color.

Apply Selected as Background Color

Use Apply Selected as Background Color  to change the background color for the embroidery.

- Click a color in the list, then click Apply Selected as Background Color. The background color for the embroidery changes.

Remove Background Color

When this is selected, the Thread Color Preview shows any areas that will be removed as a checkerboard pattern.

- Select the Remove Background Color checkbox, then select Main Background Only or All Background Areas from the pop-up menu:

Main Background Only: Any areas of the background color that are connected to the edges of the picture are not used in the final design. Use this option when significant parts of the picture use the same color as the background.

All Background Areas: All areas using the background color are omitted from the final design. Use this option when the background shows through gaps in the composition. Also choose this if you wish to remove a background color that is not connected to the edges of the picture.

Current Background Color

The large color square shows the current background color.

Removing Multiple Background Colors

Some pictures may have more than one background color, even after color reduction. These colors can be removed.

Note: If the thread color used for the background color is the same as for a color area that you wish to keep, change the background thread color to a 'false color' that is not needed for this design.

- Change the thread color so that all the background colors use the same thread color.

Picture Options

Use Picture Options to set the Black Lines option and the Area Sensitivity.

- Click the Picture Options button. The Picture Options dialog opens. See "Picture Options" on page 220.

Previews

Source Picture: This shows the original picture, after being rotated and cropped, in full color.

Thread Color Preview: This shows how the thread colors have been chosen to replace colors in the picture. This gives an approximate indication of where thread blocks will be in the final design.

Note: If variegated threads have been selected, only the first color is shown in the preview.

Zoom

Use the Zoom bar to change the view of the picture. Zoom in (drag the slider to the right) to magnify the view. Zoom out (drag the slider to the left) to shrink the view.

When zoomed in, use the scroll bars or swipe to move around.

Go Back

Return to the Design Size page.

Continue

Go to the Fabric and Stitch Type Options page.

Picture Options

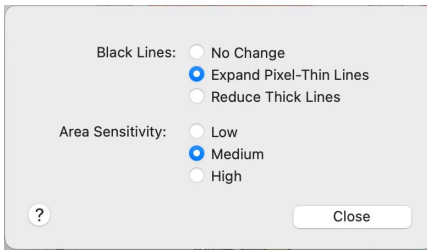

Use the Picture Options dialog to set the **Black Lines** option and the **Area Sensitivity**.

Black Lines

There are three options for handling black lines in your picture. **Expand Pixel-Thin Lines** is chosen by default.

No Change: Select **No Change** if the outlines in the picture do not need to be expanded or reduced.

Expand Pixel-thin Lines: Select **Expand Pixel-Thin Lines** to make black lines thicker. This prevents broken lines where pixels join at corners. This option is on by default, to ensure that outlines in the picture are continuous.

Reduce Thick Lines: Select **Reduce Thick Lines** if your picture has very heavy outlines, and you prefer to have markout stitching in your picture rather than satin outlines.

Area Sensitivity

Area Sensitivity is used to determine the significance of small areas of color in the picture. Area Sensitivity is set to **Medium** each time the ExpressDesign Assistant is used.

- Select from **High**, **Medium** or **Low**.
 - **High** sensitivity increases the detail extracted from the picture. This is useful, for example, when facial details are ignored at **Medium** sensitivity.
 - **Low** sensitivity decreases the detail extracted from the picture. This is useful, for example, when unwanted details are retained in the design at **Medium** sensitivity.

Fabric and Stitch Options

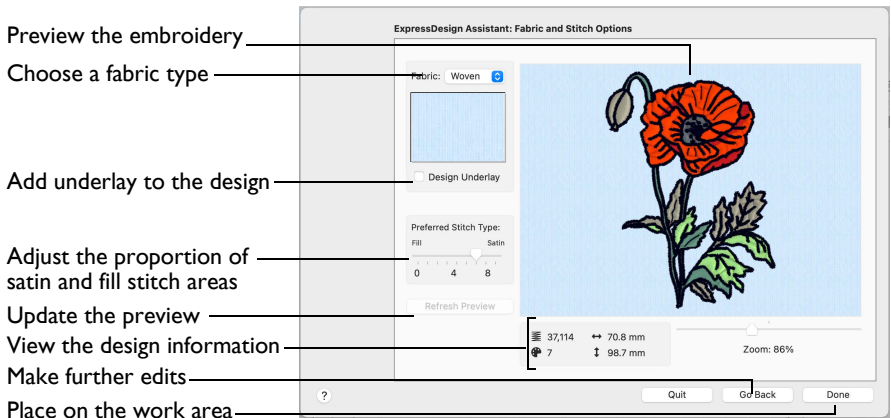

Use the Fabric and Stitch Options page to choose the typical fabric that the design will be stitched onto, and the preference for fill areas or satin areas.

Note: To see the effect of different options, click Continue to preview the design, then click Go Back if you wish to make changes and create the design again.

Fabric Advisor

Fabric

Choose the fabric on which the design will be stitched.

Note: Adjustments are made in the embroidery creation process to suit the chosen fabric, such as the type of underlay chosen for individual areas of satin or fill.

- Choose a fabric type from the pop-up menu.

Design Underlay

Design Underlay provides stitching below the whole embroidery, in addition to automatic underlay in different areas.

Note: When Design Underlay is turned off, it is easier to convert areas to lightly stitched specialty fills in mySewnet™ Stitch Editor or mySewnet™ Digitizing.

- Select Design Underlay to add underlay to the design.

Preferred Stitch Type

Use Preferred Stitch Type to choose whether areas are likely to be created as satin or fill.

Note: The design size also influences whether areas are created as satin or fill, as it sets the size of individual areas.

- To use more satin, move the slider to the right.

- To use more fill, move the slider to the left.

Zoom

Use the Zoom bar to change the view of the picture. Zoom in (drag the slider to the right) to magnify the view. Zoom out (drag the slider to the left) to shrink the view.

When zoomed in, use the scroll bars or swipe to move around.

Note: The percentage shows the size of the embroidery relative to the Real Size setting you chose in mySewnet™ Configure.

Thread Color Preview

This shows how the thread colors have been chosen to replace colors in the picture. This gives an approximate indication of where thread blocks will be in the final design.

Design Information

The design information boxes show the number of stitches in the embroidery, the height and width and the number of color blocks.

Go Back

If desired, use the Back button to go back through the ExpressDesign Assistant and modify settings before previewing the design again.

Done

Accept the final design and close the ExpressDesign Assistant.

Outline Finder and Expander

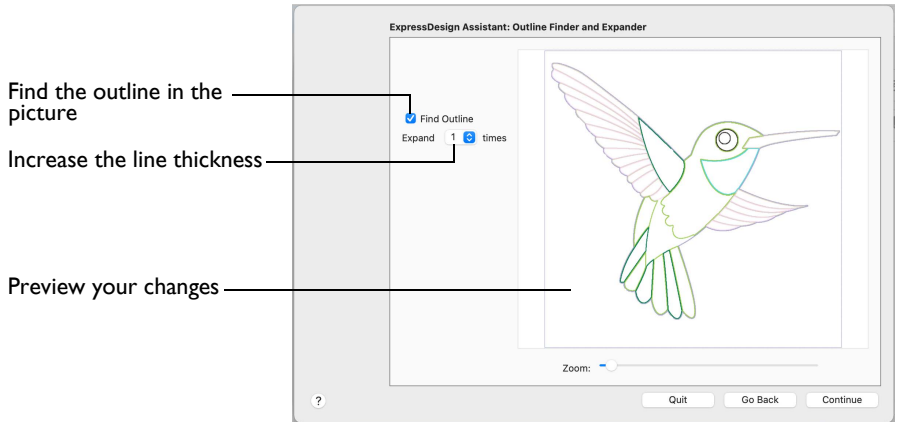

The Outline Finder and Expander page of the ExpressDesign Assistant only appears when you are creating a Quick Trace design.

Use the Outline Finder and Expander page to create outlines appropriate for tracing from solid color areas in the picture.

Find Outline

Use Find Outline to create outlines from solid color areas in the picture. A line drawing created from the color areas is shown in the preview.

Note: Find Outline looks for distinctive boundaries between color areas in the picture. Pictures with gradual color changes, such as photographs or previously scanned pictures saved in JPEG format, may not have strong color boundaries that can be detected by Find Outline.

It is usually not necessary to use Find Outline for a picture with black outlining. However, if there are additional color boundaries that do not have outlining in the picture, you may still wish to use Find Outline.

- Select Find Outline to detect the outlines in your picture.

Expand

Use Expand to expand the width of the outline detected by Find Outline. Expand is only available when Find Outline is selected.

- Choose a width for the outline from the pop-up menu.

Use Expand to increase the thickness of outlines that have been detected, by adding up to 5 pixels on each side of the lines. (Initially set to 1.)

Lines are traced down the center by Quick Trace, so setting Expand to at least 1 allows curves to be traced more smoothly and continuously.

Note: If Expand is set to 0 (zero), the outlines from the picture are one pixel wide. When a line changes direction, there may be a break in the line where pixels meet at a corner, and the line may be traced in multiple sections, or not at all.

You can use higher Expand values to merge parallel outlines that are close together. Alternatively, you may be able to exclude unwanted lines by using Monochrome Threshold on the next page.

Zoom

Use the Zoom bar to change the view of the picture. Zoom in (drag the slider to the right) to magnify the view. Zoom out (drag the slider to the left) to shrink the view.

When zoomed in, use the scroll bars or swipe to move around.

Note: The percentage shows the size of the embroidery relative to the Real Size setting you chose in mySewnet™ Configure.

Preview

The preview shows the picture. If Find Outline is selected, the preview shows the outlines that have been found, and the effect of using Expand.

Go Back

Return to the Design Size page.

Continue

Go to the Monochrome Threshold page.

Monochrome Threshold

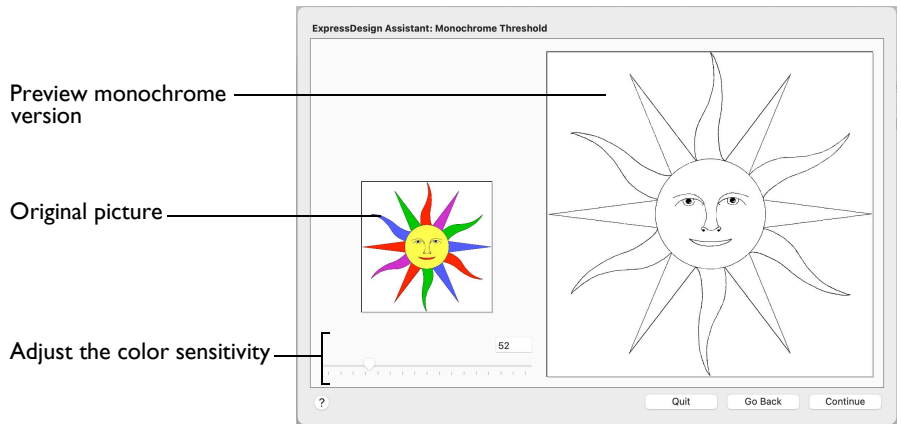

Use Monochrome Threshold to turn all shades or colors in the picture into either black or white. It acts on the whole picture. Monochrome Threshold creates defined areas that are suitable for creating the final design.

The Monochrome Threshold page of the ExpressDesign Assistant only appears when you are creating a Quick Trace or Quick Border design.

Note: Interior details within enclosed shapes in the picture are not preserved when creating a Quick Border.

- Drag the Monochrome Threshold slider to the desired setting, click to the left or right of the slider, or enter a number in the box.

Set the Monochrome Threshold between 0 and 255. Move the slider to the right to make more of the image black, and move the slider to the left to make more of the image white.

Original Picture

The thumbnail on the left shows the original picture. This allows you to see which colors in the picture have been turned black or white.

Preview

The preview picture shows the result of applying the Monochrome Threshold.

Go Back

Return to the Design Size page or the Outline Finder and Expander page, according to the chosen design type.

Continue

Go to the Express Trace Options page or the Express Border Options page, according to the chosen design type.

Express Trace Options

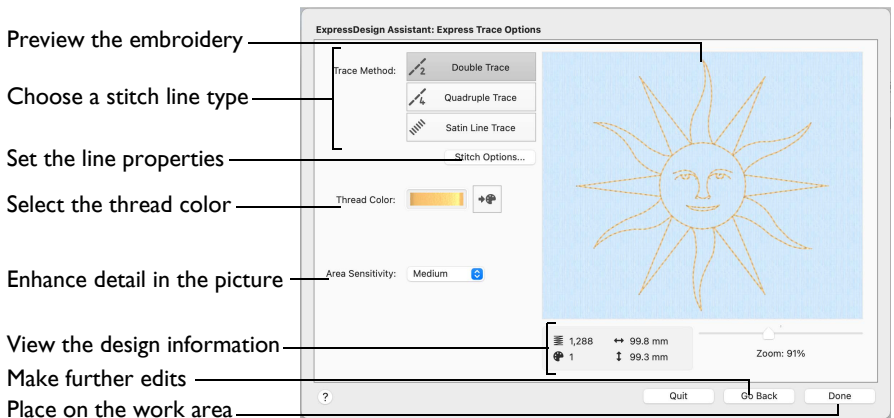

Use the Express Trace Options page to select the line type for the embroidery, and the thread color. Double Trace traces the lines in the picture with a combination of double and running stitch, Quadruple Trace uses a combination of triple and running stitch, and Satin Line Trace uses a satin line.

The Express Trace Options page only appears when you are creating a Express Trace design.

Trace Method

Select the line type for tracing the picture from one of the following:

Double Trace: Trace the picture with Double Stitch where possible, with a layer of Running Stitch where necessary.

Quadruple Trace: Trace the picture with Triple Stitch where possible, with an additional layer of Running Stitch where necessary.

Satin Line Trace: Trace the picture with satin line, using the same width and density for the satin line throughout.

- Click one of the Trace Method buttons to select the stitch type.

Options

Use Options to adjust the stitch properties for the selected Trace Method in the properties dialog for that stitch type.

- If Double Trace or Quadruple Trace are selected the Trace Options dialog is displayed.
 - If Satin Line Trace is selected the Satin Line dialog is displayed. See “Satin Line” on page 504.
- Click the Options button to see the options dialog.

Trace Options

Use the Trace Options dialog to set the Stitch Length of the running stitch to use for Double Trace and Quadruple Trace.

- Click the arrows to set Length from 1 to 12mm in steps of 0.1mm, or enter a value in the number box. The initial setting is 2mm.

Thread Color

Set the Thread Color for the stitches. The thread sample is updated with the selected color.

- Click the Color Change button  to choose a different color in the Color Selection dialog. See “Color Selection Dialog” on page 79.

Area Sensitivity

Use Area Sensitivity to determine the significance of small areas of color in the picture.

Area Sensitivity is set to Medium each time the ExpressDesign Assistant is used.

- Use High sensitivity to increase the detail extracted from the picture. This is useful, for example, when details are ignored at Medium sensitivity.
 - Use Low sensitivity to decrease the detail extracted from the picture. This is useful, for example, when unwanted details are retained in the design at Medium sensitivity.
- Choose High, Medium or Low from the pop-up menu.

Design Information

The design information boxes show the number of stitches in the embroidery, the height and width and the number of color blocks.

Zoom

Use the Zoom bar to change the view of the embroidery. Zoom in (drag the slider to the right) to magnify the view. Zoom out (drag the slider to the left) to shrink the view.

When zoomed in, use the scroll bars or swipe to move around.

Note: The percentage shows the size of the embroidery relative to the Real Size setting you chose in mySewnet™ Configure.

Preview

The preview shows the embroidery produced by tracing the lines in the picture.

Go Back

Return to the Monochrome Threshold page.

Done

Accept the final design and close the ExpressDesign Assistant.

Express Border Options

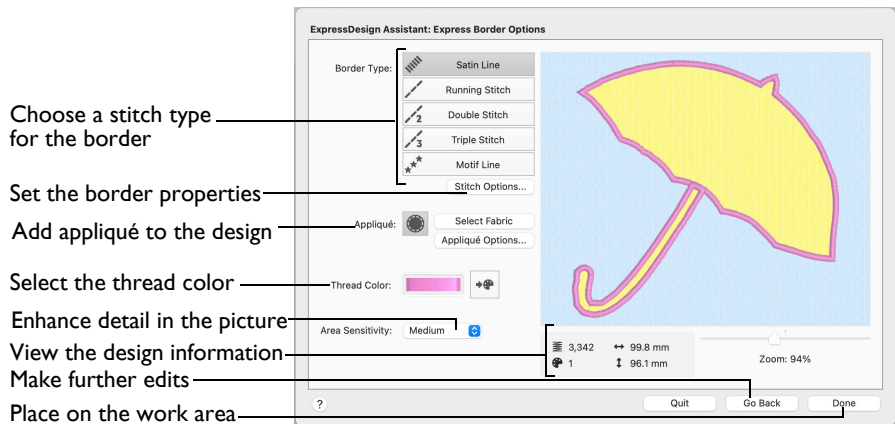

Use the Border Options to select the type of stitching used for the borders, and to choose the thread color.

The Express Border Options page only appears when you are creating a Express Border design.

Border Type

Select the type of border to create around areas of the picture from one of the following:

- Satin Line: see “Satin Line” on page 504.
- Running Stitch: see “Running Stitch” on page 501.
- Double Stitch: see “Double Stitch” on page 501.
- Triple Stitch: see “Triple Stitch” on page 503.
- Motif Line: see “Motif Line” on page 506.

Stitch Options

Use Stitch Options to show the options dialog for the selected border type. If desired, adjust the properties.

- Click the Stitch Options button to see the options dialog.

Appliqué

Select Appliqué to use appliqué within the borders of the design.

- Click Select Fabric to change the appliqué fabric. See “Appliqué Selection” on page 195.
- Click Appliqué Options to select the appliqué type. See “Appliqué Options” on page 232.

Note: When Appliqué is selected, the preview shows where the appliqué fabric should be placed.

Thread Color

Set the Thread Color for the stitches. The thread sample is updated with the selected color.

- Click the Color Change button  to choose a different color in the Color Selection dialog. See “Color Selection Dialog” on page 79.

Area Sensitivity

Use Area Sensitivity to determine the significance of small areas of color in the picture.

Area Sensitivity is set to Medium each time the ExpressDesign Assistant is used.

- Use High sensitivity to increase the detail extracted from the picture. This is useful, for example, when details are ignored at Medium sensitivity.
 - Use Low sensitivity to decrease the detail extracted from the picture. This is useful, for example, when unwanted details are retained in the design at Medium sensitivity.
- Choose High, Medium or Low from the pop-up menu.

Zoom

Use the Zoom bar to change the view of the embroidery. Zoom in (drag the slider to the right) to magnify the view. Zoom out (drag the slider to the left) to shrink the view.

When zoomed in, use the scroll bars or swipe to move around.

Note: The percentage shows the size of the embroidery relative to the Real Size setting you chose in mySewnet™ Configure.

Preview

The preview shows the border embroidery that will be created, using the chosen thread color and stitch type.

Done

Accept the final design and close the ExpressDesign Assistant.

Appliqué Options

Use the Appliqué Options dialog to set the properties for the satin line and placement lines used in the appliqué area, and to select an appliqué method.

Set density and width for the satin borders, running and double stitch lengths, and select the appliqué method.

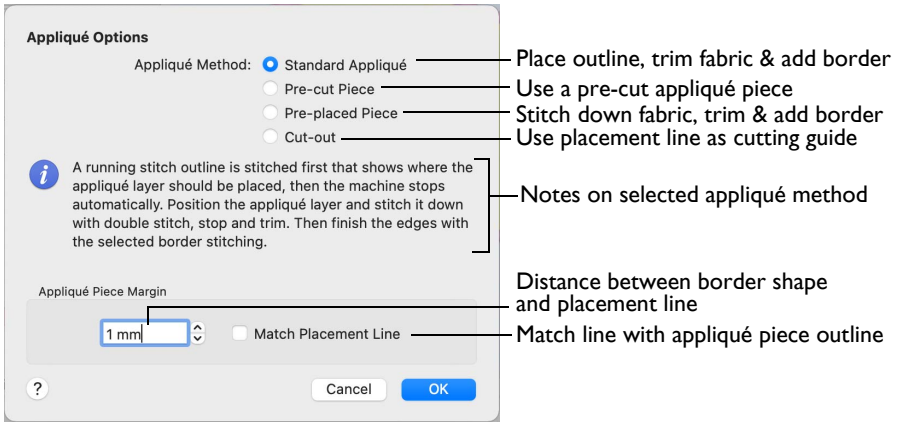

Appliqué Method

Choose the method for placing and securing the appliqué fabric.

- **Standard Appliqué**
Stitch a running line to show where appliqué fabric should be placed, then stop to position the fabric. Stitch down the appliqué fabric with double stitch, then stop so the fabric may be trimmed. Finish the edges with the selected border stitching.
- **Pre-cut Piece**
Use a pre-cut appliqué piece; created, for example, using an automatic cutter or cutwork needles.
Stitch a running line to show where the pre-cut appliqué piece should be placed, then stop to position the appliqué piece. Stitch down the appliqué piece with double stitch, then finish the edges with the selected border stitching.
- **Pre-placed Piece**
Place the appliqué fabric before stitching.
Place the appliqué layer in position, then stitch down the appliqué fabric with double stitch. Stop so the fabric may be trimmed. Finish the edges with the selected border stitching.
- **Cut-out**
Use the appliqué placement line as a guide to where the fabric should be cut; for example for reverse appliqué.

Stitch a double stitch line. Stop so the fabric may be cut to form a hole defined by the stitched outline. Finish the edges with the selected border stitching.

Appliqué Piece Margin

Set the margin for appliqué placement relative to the drawn border shape from -10mm to 10mm. The initial value is 1.0mm.

Note: Use a positive value when trimming the appliqué fabric before the border is stitched, for example with Standard Appliqué and Pre-placed Appliqué. A negative value is recommended for cut-out and reverse appliqué.

Match Placement Line

Adjust the position of the first running stitch line for either Standard Appliqué or Pre-cut Piece so that it matches the outline of the appliqué piece after the Appliqué Piece Margin has been applied.

Note: This may be useful for precise positioning of appliqué pieces that have been pre-cut with an automated cutter, to ensure the placement line is visible.

Stitching Out an Appliqué Area

Appliqué embroideries are designed to be stitched out in a particular sequence. When stitching out an appliqué embroidery using Method 2, do as follows:

- 1 Begin embroidering. A running line will show where to position the appliqué fabric.
- 2 A stop then allows you to place the fabric.
- 3 Stitch down the appliqué fabric with double stitch.
- 4 Next there is a color change so you can trim the fabric, and change the color for the first color of the embroidery.
- 5 Finally, finish the edges with the satin border.

Note: The placement section in the appliqué is the same color as the first color in the design, so it doesn't show under the appliqué fabric. If desired, change in mySewnet™ Embroidery to the first color of the embroidery.

Go Back







Return to the Monochrome Threshold page.

Done

Accept the final design and close the ExpressDesign Assistant.

ExpressDesign Assistant Examples

Create a Happy Sun Embroidery

- 1 If required, choose File > New.
- 2 Click the Hoop button  and set the hoop size to 150mm x 150mm - Universal Square Hoop 2. See “Hoop Selection” on page 22.
- 3 In the Create window  of the Control Panel  click ExpressDesign  > ExpressDesign into Rectangle. The pointer changes to the draw rectangle pointer .
- 4 Starting at the corner of a grid square, drag to draw a square that is ten by ten grid squares.
Note: If the rectangle is wrong and you wish to try again, click Quit when the Choose Picture page of the ExpressDesign Assistant appears and return to step 3.
- 5 Release the mouse button. The Select ExpressDesign Method page of the ExpressDesign Assistant appears.
- 6 Ensure that Create Express Embroidery is selected.
- 7 Click Continue. The Choose Picture page of the ExpressDesign Assistant appears.
- 8 Click Select File.
- 9 In the Open dialog, browse to the folder mySewnet/Samples/Embroidery/Pics.
- 10 Click 'Happy Sun.png', then click Open.
The picture is loaded onto the Choose Picture page, with its name shown below the preview area.
- 11 Click Continue and the Rotate and Crop Picture page appears.
- 12 No rotation or adjustment of crop lines is required, so click Continue.
- 13 In the Design Size page ensure the width  is set to 100mm.
Note: The height will automatically change proportionally.
- 14 Click Continue. The Choose Thread Colors page appears.
- 15 Ensure the Remove Background Color checkbox is selected. The white background is removed.
- 16 Click the Picture Options button. In the Picture Options dialog, ensure that Expand Pixel-Thin Lines is selected in Black Lines.
- 17 In Area Sensitivity, ensure that the setting is Medium.
- 18 Click Close.
- 19 Click Continue and the Fabric and Stitch Options page appears.
- 20 Leave fabric as Woven.
- 21 Ensure that Design Underlay is selected.

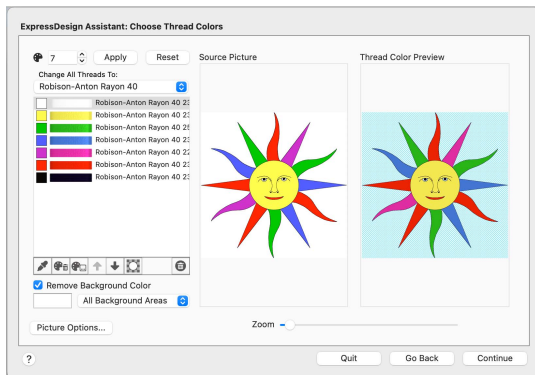
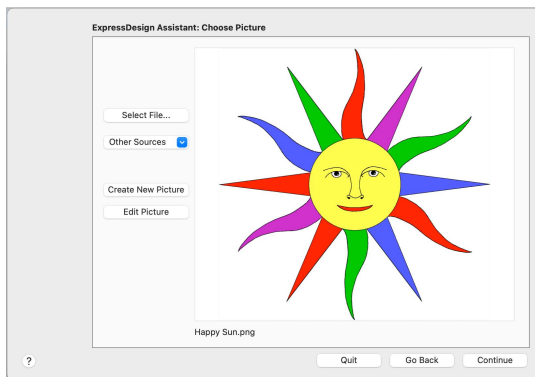



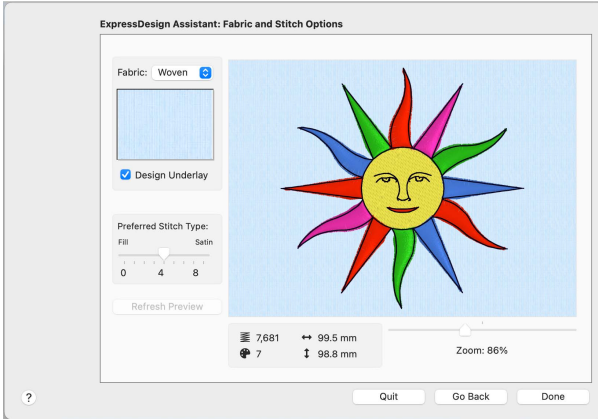

- 22 Move the Preferred Stitch Type slider to 4. This will use fill for the sun's face, and satin for the sun's rays.
- 23 Click Refresh Preview to view the changes.

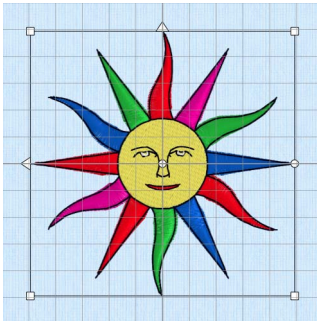

- 24 Click Done. The Happy Sun embroidery appears on the work area, where the rectangle was drawn.



Create a Happy Sun Express Trace

- 1 If required, choose File > New.
- 2 Click the Hoop button  and set the hoop size to 150mm x 150mm - Universal Square Hoop 2. See “Hoop Selection” on page 22.
- 3 In the Create window  of the Control Panel  click ExpressDesign  > ExpressDesign into Rectangle. The pointer changes to the draw rectangle pointer .
- 4 Starting at the corner of a grid square, drag to draw a square that is seven by seven grid squares.
Note: If the rectangle is wrong and you wish to try again, click Quit when the Choose Picture page of the ExpressDesign Assistant appears and return to step 3.
- 5 Release the mouse button. The Select ExpressDesign Method page of the ExpressDesign Assistant appears.
- 6 Select Create Express Trace.
- 7 Click Continue. The Choose Picture page of the ExpressDesign Assistant appears.
- 8 Click Select File.
- 9 In the Open dialog, browse to the folder mySewnet/Samples/Embroidery/Pics.
- 10 Click 'Happy Sun.png', then click Open.

The picture is loaded onto the Choose Picture page, with its name shown below the preview area.

- 11 Click Continue and the Rotate and Crop Picture page appears.

- 12 No rotation or adjustment of crop lines is required, so click Continue.

- 13 In the Design Size page ensure the width  is set to about 70mm.
Note: The height will automatically change proportionally.

- 14 Click Continue and the Outline Finder and Expander page appears.

- 15 Check that Find Outline is not selected. The picture has good outlines that can be used.

- 16 Click Continue and the Monochrome Threshold page appears.

- 17 Set the Monochrome Threshold to less than 52, so that only the outlines show in the preview.

- 18 Click Continue and the Express Trace Options page appears.



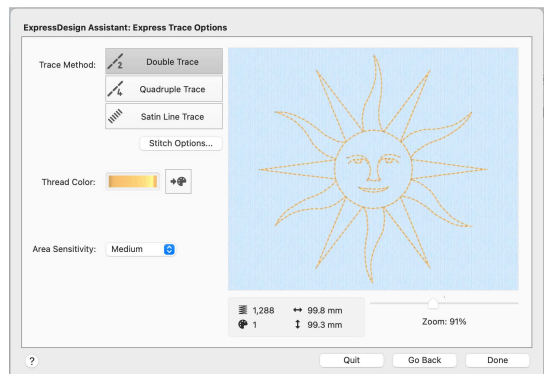
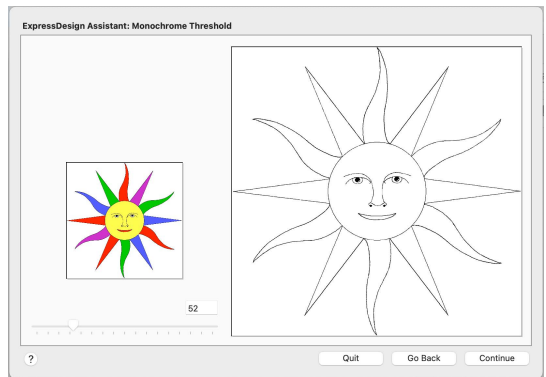

- 19 Ensure Double Trace is selected.
 - Double Trace traces lines in the picture with a combination of double stitch and running stitch.
 - Quadruple Trace creates a bolder effect by using a combination of triple stitch and running stitch.

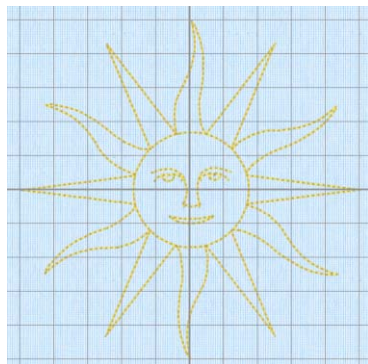



- 20 Click the Thread Color button  and set the thread color to Sulky Rayon 40 1 | 24 (Sun Yellow), then click OK. The preview shows the traced embroidery in the chosen thread color.
- 21 Click Done and the Happy Sun embroidery appears on the work area, where the rectangle was drawn.

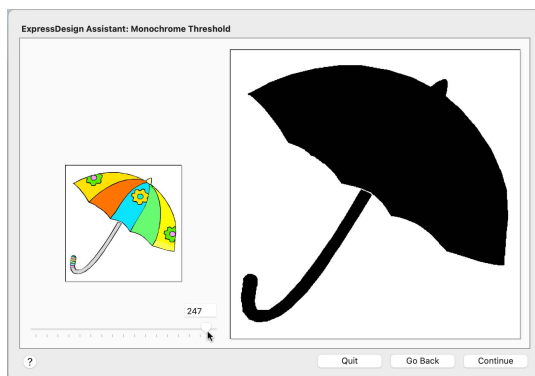

Create an Umbrella Border

- 1 If required, choose File > New.
- 2 Click the Hoop button  and set the hoop size to 100mm x 100mm - Universal Square Hoop 1. See “Hoop Selection” on page 22.
- 3 In the Create window  of the Control Panel  click ExpressDesign  > ExpressDesign into Hoop. Alternatively, choose Assistants > ExpressDesign > ExpressDesign into Hoop. The Select ExpressDesign Method page of the ExpressDesign Assistant appears.
- 4 Select Create Express Border.
- 5 Click Continue. The Choose Picture page of the ExpressDesign Assistant appears.
- 6 Click Select File.
- 7 In the Open dialog, browse to the folder mySewnet/Samples/Embroidery/Pics.
- 8 Click 'Umbrella.png', then click Open.
The picture is loaded onto the Choose Picture page, with its name shown below the preview area.
- 9 Click Continue and the Rotate and Crop Picture page appears.
- 10 Click Select All, then click Continue.
This will create a small margin around the embroidery, so that it does not touch the edge of the hoop area.
- 11 The embroidery size is set by the size of the hoop, so in the Design Size page click Continue. The Monochrome Threshold page appears.
- 12 Set the Monochrome Threshold to 246 or more, so that all of the colored areas in the umbrella are black.
This creates a clearly defined shape to use for the border. If a lower number is used, extra lines may appear in the umbrella handle, or there may be gaps.
- 13 Click Continue, and the Express Border Options page appears.



- 14 Ensure that Satin Line is selected as the Border Type.
- 15 Click Options. The Satin Line dialog appears.
- 16 Ensure that Width is set to 2.0mm, that Density is set to 4, and that Underlay is selected, then click OK.
- 17 Click the Thread Color button  and set the thread color to Robison-Anton Rayon 40 2259 (Wild Pink).
- 18 Click OK. The umbrella is now pink.
- 19 Ensure that Appliqué  is selected.
- 20 Click Select Fabric.
- 21 In the Quick Appliqué Colors section of the Appliqué Selection dialog, choose a color that will match the satin line for the border.
- 22 Click Done to place the embroidery on the work area.

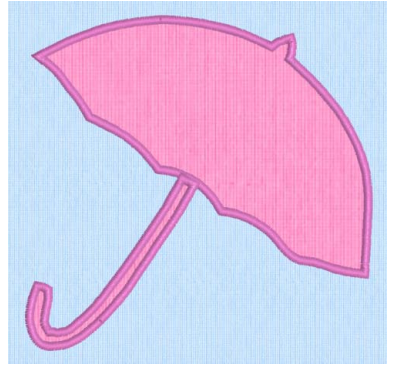

Use the Quilt Block Assistant to create a filled or outline quilt block automatically – you can even create a quilting fill around an embroidery!



Use the Quilt Block Assistant  to create a filled or outline quilt block automatically, or a block with a quilting fill around an embroidery.





Quilt Block Assistant

Use the Quilt Block Assistant to create a quilt block automatically. The Quilt Block Assistant opens at the Select Quilt Block Style page.

Open the Quilt Block Assistant

- In the Create window  of the Control Panel  click Quilt Block Assistant .
- Choose Assistants > Quilt Block Assistant.

Use the Quilt Block Assistant

- 1 In the Create window  of the Control Panel  click Quilt Block Assistant . Alternatively, choose Assistants > Quilt Block Assistant.
- 2 Select a quilt block style.
- 3 Step through the rest of the Quilt Block Assistant.
When you finish, the quilt block is in the center of the hoop.
- 4 Use Save, then Export to keep the new quilt block.
The most recently used quilt block dimensions are remembered, even if the program has been restarted.

Information about the Fill Pattern used is stored in the settings of the embroidery that is created.

Select Quilt Block Style

Use the Select Quilt Block Style page to select one of five quilt block styles.

- Surround an embroidery with a fill
- Filled shape within a quilt block
- Unfilled shape surrounded by a fill
- Filled quilt block
- Quilt block; no shape or fill

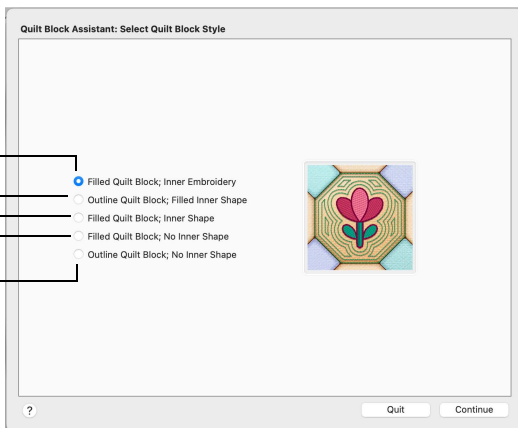

Filled Quilt Block; Inner Embroidery

Use Filled Quilt Block; Inner Embroidery to make a filled quilt block surrounding an embroidery.



Outline Quilt Block; Filled Inner Shape

Use Outline Quilt Block; Filled Inner Shape to make an unfilled quilt block containing a filled shape.



Filled Quilt Block; Outline Inner Shape

Use Filled Quilt Block; Outline Inner Shape to make a quilt block with an unfilled shape, surrounded by a fill.



Filled Quilt Block; No Inner Shape

Use Filled Quilt Block; No Inner Shape to fill the quilt block with a motif or pattern.

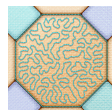

Outline Quilt Block; No Inner Shape

Use Outline Quilt Block; No Inner Shape to create a quilt block without any internal shape or fill. This option is useful when creating blocks to piece.



- Select a style for the quilt block, then click Continue.

Continue

Go to the Select Quilt Block page.

Select Size

Use the Select Size page to set the quilt block shape, size, angle, and add a cut line around the block.

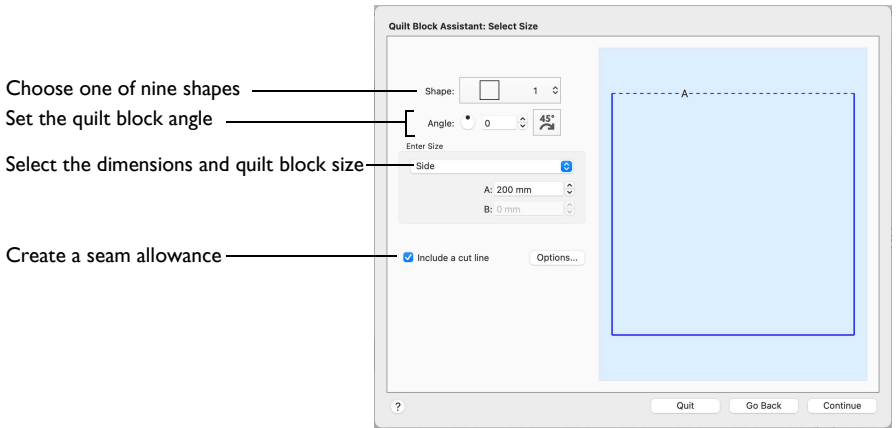

Shape

Use one of nine shapes for the quilt block.

- Choose a shape from the pop-up menu.

Note: All of these quilt block shapes can be tessellated — they will fill an area if tiled individually or combined with another shape, with no overlaps or gaps.

Angle

Use Angle to set the angle at which the quilt block is created and displayed from 0 to 359 degrees. This is an easy way to place a block "on point".

Changes in Angle are visible in the preview.

Set the Angle for the Quilt Block

- Enter a number in the angle number box.
- Click the arrows to increase or decrease the angle.
- Drag the rotational slider to set the quilt block angle.
- Click the Rotate 45 button  to rotate the shape by 45 degrees in a clockwise direction.

Enter Size

Set the dimensions to measure for your quilt block, and enter the desired size(s). The selected dimension is indicated by a dotted line and the letter A or B.

Note: The default dimensions depend upon the shape selected. For example, the minimum size for the sides of a square block is 10mm and the maximum size is 1m.

Enter the Quilt Block Size

- Choose the dimension(s) to be measured from the pop-up menu, then use the up and down arrows to set the size.

Cut Line

Cut Line adds a stitch line outside the edge of the quilt block to indicate where the fabric is to be cut and folded as a quilt block. Set the seam allowance in the Cut Line Options dialog.

Include a cut line

- Select 'Include a cut line' to add a cut line to your quilt block, then click Options to set the seam allowance in the Cut Line Options dialog.

Cut Line Options

Use the Cut Line Options dialog to set the Margin and Stitch Length for your quilt block.

Margin

Use Margin to set the distance between the quilt block and the Cut Line.

- Click the arrows to set Margin from 1 to 100mm, or enter a value in the number box.

Stitch Length

Use Stitch Length to set the length of the stitches in the cut line.

- Click the arrows to set stitch length from 0.3mm to 12mm.

Go Back

Return to the Select Quilt Block Style page.

Continue

If you selected 'Filled Quilt Block; Inner Embroidery' on the Select Quilt Block Style page, go to the Load Embroidery page.

If you selected 'Filled Quilt Block; No Inner Shape' on the Select Quilt Block Style page, go to the Select Fill pattern page.

If you selected a quilt block with an Inner Shape on the Select Quilt Block Style page, go to the Select Shape page.

Done

If you selected 'Outline Quilt Block; No Inner Shape' on the Select Quilt Block Style page, click Done to close the Assistant.

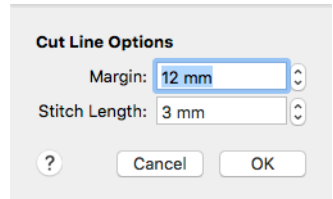

Load Embroidery

Use the Load Embroidery page to load an embroidery to use in the center of your quilt block.

This page appears if you chose Filled Quilt Block; Inner Embroidery in the Select Quilt Block Style page.

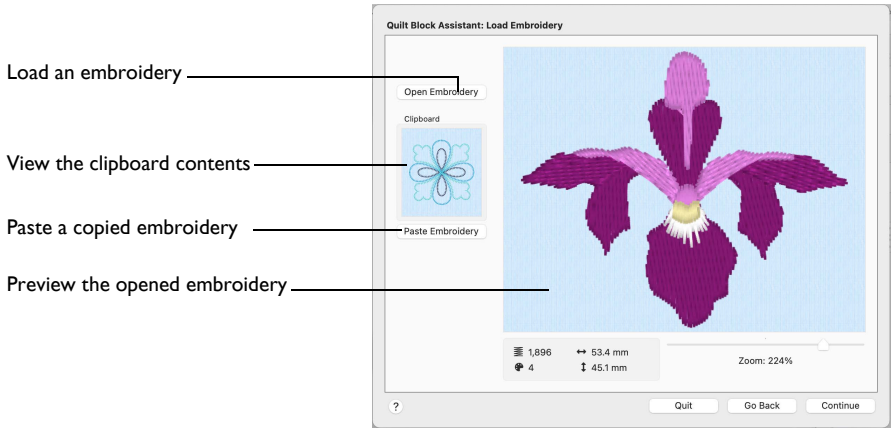

After choosing an embroidery, you can select a different embroidery but only the most recently chosen embroidery is shown on the preview area.

Note: It is not possible to drag an embroidery onto the Quilt Block Assistant from the Finder.

Open Embroidery

Use Open Embroidery to load an embroidery in the preview area using the Open dialog.

- Click Open Embroidery, select an embroidery in the Open dialog, and click Open to load the embroidery.

Paste Embroidery





Paste Embroidery loads the embroidery shown in the Clipboard. When pasted, the embroidery is shown in the preview area.

- Click Paste Embroidery to load the copied embroidery in the Clipboard.

Clipboard

The Clipboard shows the embroidery, if any, that has been copied or cut to the clipboard, either from another mySewnet™ Embroidery Software app or from within mySewnet™ Embroidery before the Quilt Block Assistant was started.

Preview

View the embroidery, and its stitch count , width , height  and number of color blocks .

Go Back

Return to the Select Size page.

Continue

Go to the Adjust Embroidery page.

Adjust Embroidery

Use the Adjust Embroidery page to set the angle and position of the embroidery within the quilt block, and the margin around it.

This page appears after the Load Embroidery page if you chose Filled Quilt Block; Inner Embroidery in the Select Quilt Block Style page.

Note: If you loaded an embroidery that was too large for the specified quilt block, it is outlined in red. Return to the Select Size page and choose a different size for the quilt block, or select another embroidery.

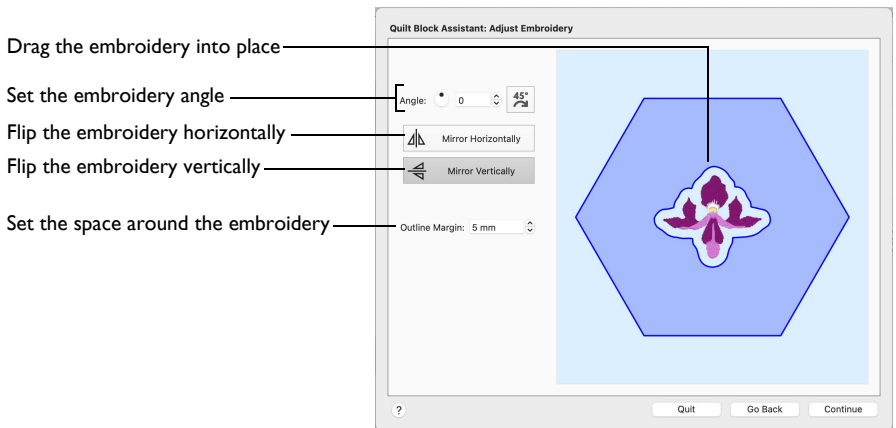

Note: To reset all the settings quickly, go back to the Load Embroidery page and load the design again.

Position

- Drag anywhere inside the solid blue line around the embroidery (the margin) to move the embroidery.

Note: If you drag the embroidery so that the margin is outside the edge of the quilt block, the outline becomes red, and the Continue button is dimmed (unavailable).

Angle

Use Angle to set the angle at which the embroidery is displayed from 0 to 359 degrees. The changes are shown in the preview.

Set the Angle for the Embroidery

- Enter a number in the angle number box.
- Click the arrows to increase or decrease the angle.
- Drag the rotational slider to set the angle.
- Click the Rotate 45 button  to rotate the embroidery by 45 degrees in a clockwise direction.

Mirror Horizontally

Use Mirror Horizontally  to mirror the embroidery from left to right.

Mirror Vertically

Use Mirror Vertically  to mirror the embroidery from top to bottom.

Margin

Use Margin to leave space between the embroidery and the fill around it.

Note: A blue line around the embroidery indicates the position of the margin. If the margin is outside the edge of the quilt block, the outline becomes red, and the Continue button is dimmed (unavailable).

- Click the arrows to set the Margin from 0mm to 50mm.

Back

Return to the Load Embroidery page.

Continue

Go to the Select Fill Pattern page.

Select Shape

Select an internal shape for your quilt block, and set its size and angle.

This page appears if you chose to use an Inner Shape for your quilt block in the Select Quilt Block Style page.

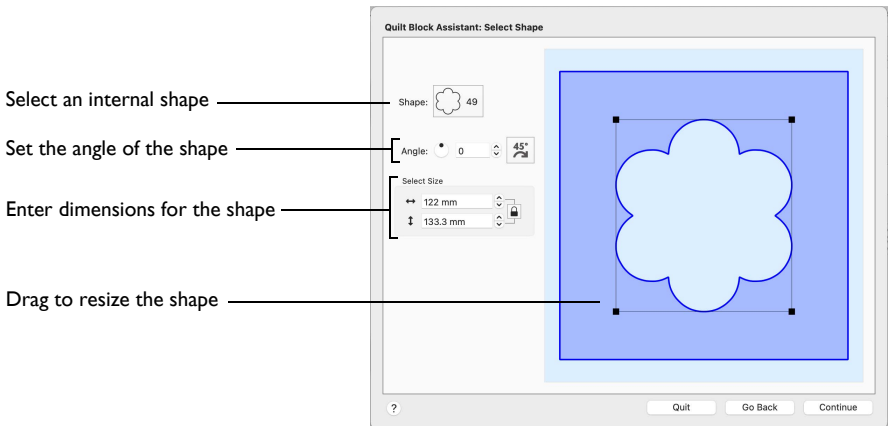
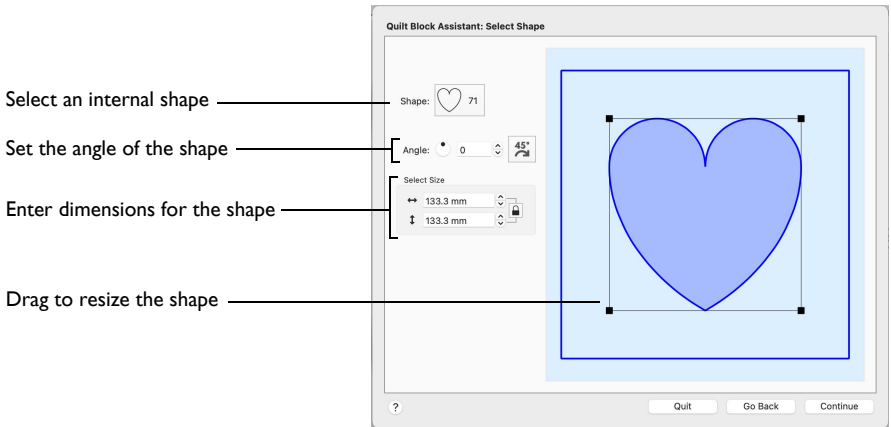

Shape

Use one of 120 shapes for the internal shape in the quilt block.

- Choose a shape from the pop-up menu.

Size and Position

Move, rotate, resize and reshape the internal shape. The Width and Height boxes show the new dimensions of the shape.

Change the position, size and dimensions of the internal shape

- Drag within the shape to reposition it in the quilt block.

- Drag one of the corner resize handles, or anywhere on the dotted line box surrounding the internal shape, to resize it.
- Click the arrows to set the Width and Height of the shape, or enter a value in the number box.
- Deselect Proportional , then adjust the dimensions to change the shape of the internal shape.

Angle

Use Angle to set the angle at which the internal shape is displayed from 0 to 359 degrees. The changes are shown in the preview.

Set the Angle for the Internal Shape

- Enter a number in the angle number box.
- Click the arrows to increase or decrease the angle.
- Drag the rotational slider to set the angle.
- Click the Rotate 45 button  to rotate the internal shape by 45 degrees in a clockwise direction.

Go Back

Return to the Select Size page.

Continue

Go to the Select Fill Pattern page.

Select Fill Pattern

Choose a fill type for your quilt block, and set the options for it.

This page appears if you chose to use a fill for your quilt block in the Select Quilt Block Style page.

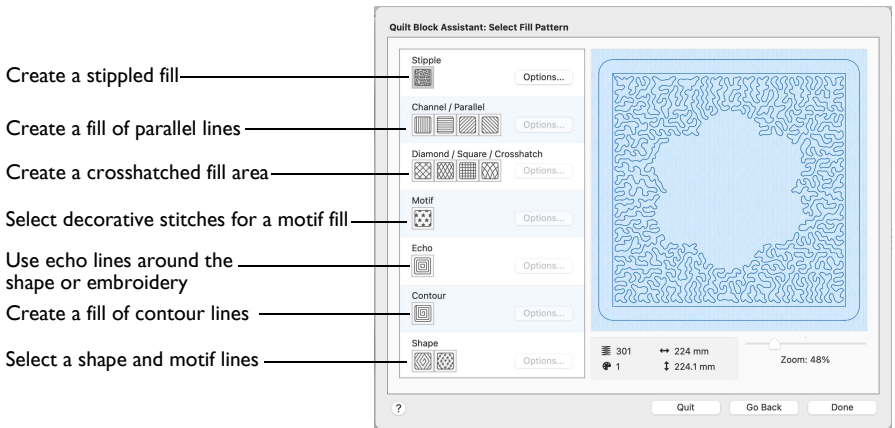
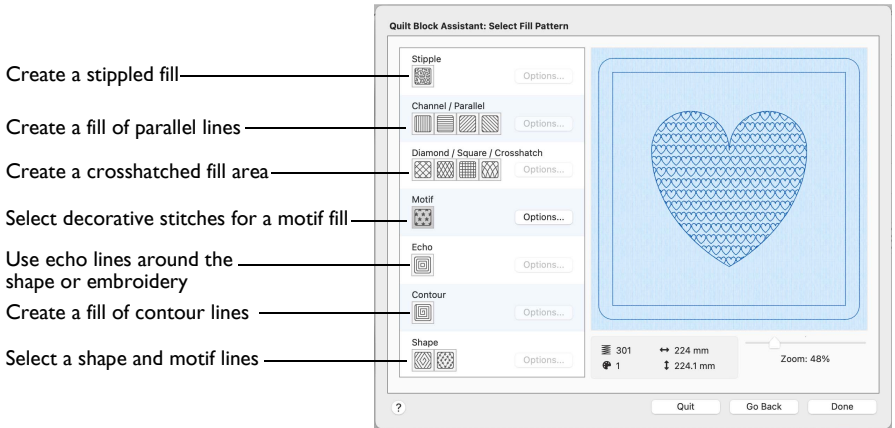

Stipple Fill





Use Stipple Fill  to create a stippled fill for an area. Set the properties for the fill in the `QuitStipple Fill Properties` dialog. See “`QuitStipple Fill`” on page 490.

Note: When created, Stipple Fill areas do not have an outline.

- Click Stipple Fill  to select the fill for the area, then click the Options button to set the properties for the stipple fill.

Channel/Parallel Fill

Use Channel/Parallel Fill to create a fill of parallel lines for an area. Four types are available:





-  Channel Fill Vertical
-  Channel Fill Horizontal
-  Channel Fill Diagonal Right
-  Channel Fill Diagonal Left

Set the properties for the Channel Fill in the Crosshatch Fill properties dialog. See “Crosshatch Fill” on page 473.

- Click the button for the desired Channel Fill type, then click the Options button to set the properties for the fill.

Diamond/Square/Crosshatch Fill

Use Diamond/Square/Crosshatch Fill to create a crosshatched fill for an area. Four types are available:

-  Crosshatch Fill
-  Diamond Fill
-  Square Fill
-  Curved Crosshatch Fill

Set the properties for the fill in the Crosshatch Fill properties dialog or the Curved Crosshatch Fill properties dialog. See “Crosshatch Fill” on page 473 and “Curved Crosshatch Fill” on page 476.

- Click the button for the desired Diamond/Square/Crosshatch Fill, then click the Options button to set the properties for the fill.

Motif Fill

Use Motif Fill  to create a motif fill for an area. Set the properties for the motif fill in the Motif Fill properties dialog. See “Motif Fill” on page 470.

- Click the button for Motif Fill , then click the Options button to select a motif, and set the properties for the fill.

Echo Fill

Use Echo Fill  to place echo lines within an area. Set the properties for the echo fill in the Echo Fill properties dialog. See “Echo Fill” on page 482.

- Click the button for Echo Fill , then click the Options button to set the properties for the fill.

Contour Fill

Use Contour Fill  to create a contour fill for an area. Set the properties for the contour fill in the Contour Fill properties dialog. See “Contour Fill” on page 492.

- Click the button for Contour Fill , then click the Options button to set the properties for the fill.



Shape Fill

Use Shape Fill to create a shape fill for an area. Two types are available:

 Shape Fill

 Shape Fill with Motifs

Set the properties for the shape fill in the Shape Fill properties dialog. See “Shape Fill” on page 484.

- Click the button for Shape Fill , or Shape Fill with Motifs , then click the Options button to set the properties for the fill.

Back





Return to the Adjust Embroidery, Select Shape, or Select Size page.

Done

Click Done to close the Assistant.

Quilt Block Assistant Examples

Surround an Embroidery in a Quilt Block with an Echo Fill

- 1 In the Create window  of the Control Panel  click Quilt Block Assistant . Alternatively, choose Assistants > Quilt Block Assistant.
The Select Quilt Block Style page appears.
- 2 Select Filled Quilt Block; Inner Embroidery .
This will create a filled quilt block with an embroidery in the center.
- 3 Click Continue. The Select Size page appears.
- 4 Look at the Shape pop-up menu. There are nine shapes to choose from. *Note:* All of these quilt block shapes can be tessellated — they will fill an area if tiled individually or combined with another shape, with no overlaps or gaps.
- 5 Choose Shape 6, a hexagon.
- 6 Look at the Enter Size pop-up menu. For a hexagon you can select from Point to Point, Side, and Side to Side.
- 7 Ensure that Point to Point is selected in Enter Size.
- 8 Set measurement A to 150mm.
- 9 Ensure that "Include a cut line" is selected.

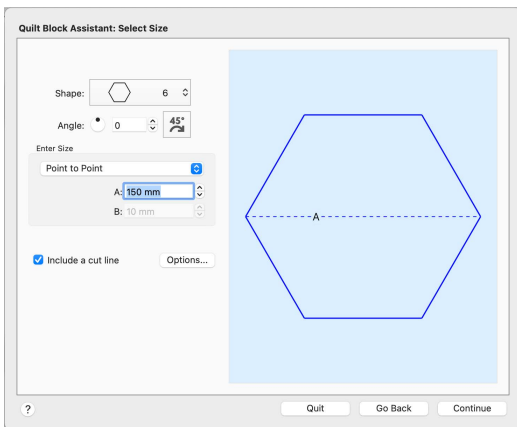
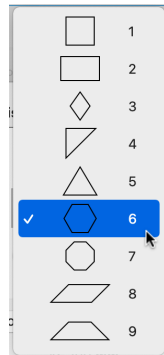

- 10 Click Continue and the Load Embroidery page of the assistant appears.
- 11 Click Open Embroidery and the Open dialog appears.
- 12 Browse to the folder mySewnet/Samples/Embroidery/Stitch.
- 13 Select the embroidery 'Iris Single.vp4'.

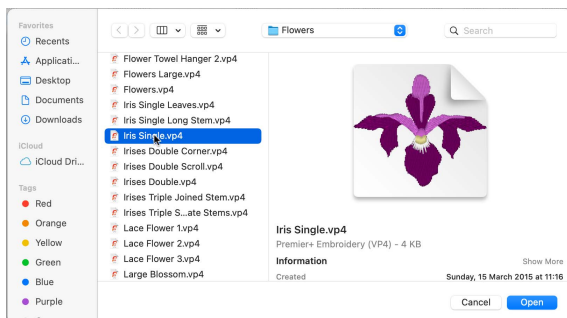

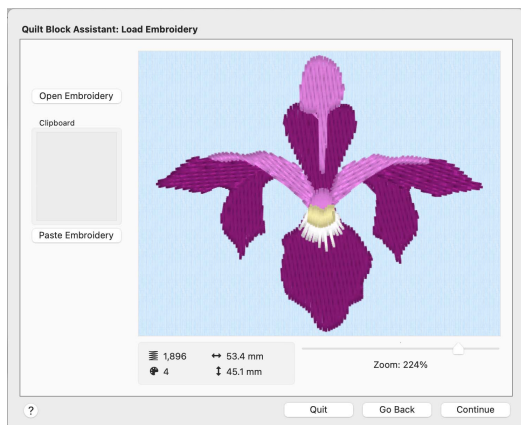

- 14 Click Open and the embroidery is loaded onto the preview area.





Note: After choosing an embroidery you can select a different embroidery, but only the most recently chosen embroidery is shown on the preview area. The dimensions, number of stitches, and thread colors used in the embroidery are shown below the preview.

- 15 Click Continue. The Adjust Embroidery page appears. The embroidery is placed in the center of the quilt block shape, with a clear margin and blue fill area surrounding it.
- 16 Click Rotate 45°  twice. The embroidery rotates clockwise by 45 degrees in the preview.

You can use Angle and Rotate 45°  to rotate the shape by 45 degrees, or an angle that you choose, in a clockwise direction.

- 17 Enter 0 in the Angle number box to return the embroidery to its original position.
- 18 Click Mirror Vertically  to reverse the embroidery.

Mirror Horizontally  mirrors the embroidery from left to right, and Mirror Vertically  mirrors the embroidery from top to bottom.

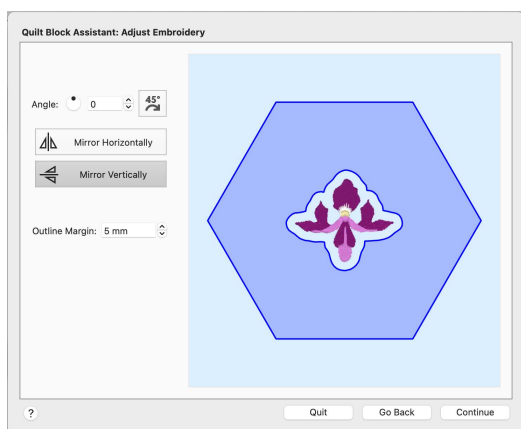

- 19 Click Mirror Vertically  again to set the embroidery back to the previous position.
- 20 Click the up arrow next to Margin to increase the margin by 2mm. The margin around the flower embroidery grows larger.

- 21 Drag the embroidery so that the margin lies outside the edge of the quilt block. The blue fill disappears, and the line showing the edge of the margin becomes red.

Note: You could drag it back to its original position, but it is just as easy to reload the embroidery.

- 22 Click Go Back. In the Load Embroidery page, click Open Embroidery to open the Open dialog and load Iris Single.vp4 again.

- 23 Click Continue. In the Adjust Embroidery page the embroidery has returned to its original position and settings.

If you had clicked Continue without loading the embroidery again, your changes would have been retained.

- 24 Click Continue. The Select Fill Pattern page appears.

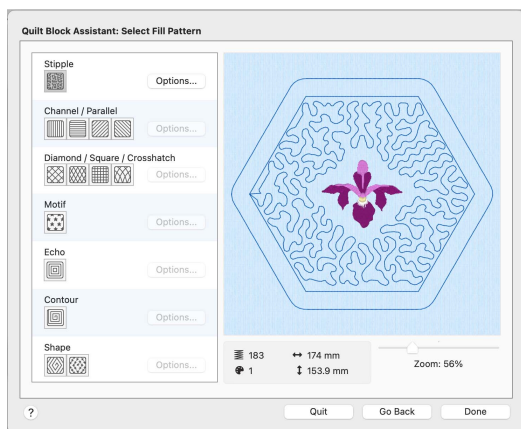
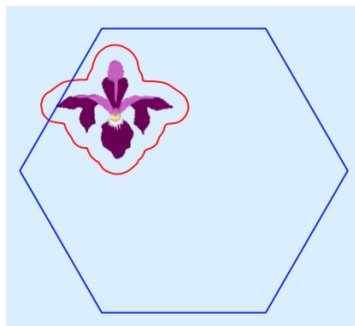

Note: The embroidery is surrounded by an unstitched margin, and the default fill, a Stipple Fill. The Options button is available to change the Stipple Fill settings.

- 25 Click Echo . The fill around the embroidery changes to an Echo Fill.

The outer lines in the echo fill follow the outline of the quilt block, while the inner lines follow the outline of the embroidery.

- 26 Click the Options button for Echo Fill. The Echo Fill properties dialog opens.

- 27 Set the Spacing to 4.0mm, and ensure the Stitch length is 1.5mm.

The Style is set to style 1, rounded corners. You can also use square (Style 2) or diagonal (Style 3) corners. These styles have more significant effects when using the Inner Shape quilt block option.

- 28 Click OK to view the effect of the changes.

- 29 The gap between the embroidery and the echo lines is greater than the gap between the lines themselves. Click Go Back to return to the Adjust Embroidery page.

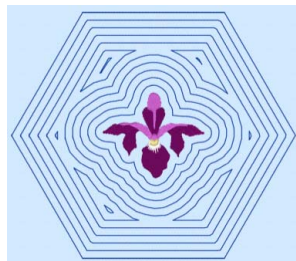

- 30 Set the Margin to 4mm, then click Continue to return to the Select Fill Pattern page. The first line in the echo fill now starts at the same distance from the embroidery as the other lines are from each other.
There are several small 'islands' around the flower.
- 31 Click Options and in the Echo Fill dialog set the Spacing to 4.2mm. Then click OK. This increases the distance between the lines of stitching, and removes the small islands.

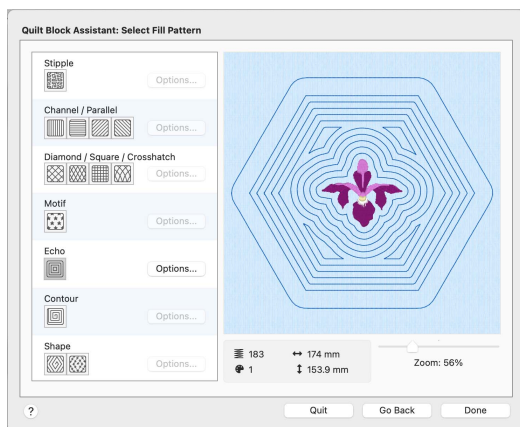

Adjust the Gap and Style, and the position of the embroidery to achieve your preferred results.

- 32 Click Done to place the finished quilt block in the work area. Two rows of stitching around the quilt block show the lines at the edge of the block where the fabric should be cut and folded.

Note the orange handles for the group created from the embroidery, the echo lines and the cut line.

- 33 In the Color Worksheet, select the color for the echo lines and change it to the dark purple used in the Iris petals in the embroidery.

The color of the stitching in the fill now matches the main color in the embroidery.

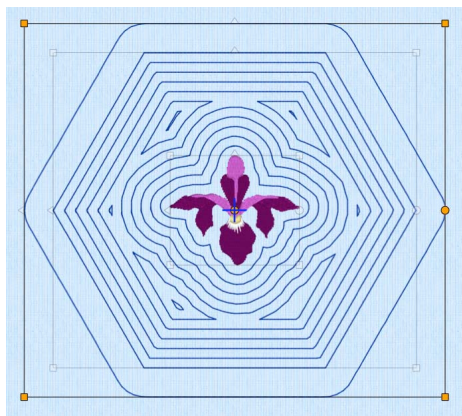



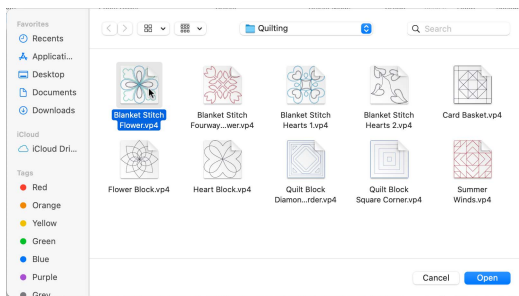

Show an Echo Around an Embroidery

- 1 Open a new mySewnet™ Embroidery window.
- 2 Choose File > Insert (or ⌘I) to load an embroidery.

- 3 In the Open dialog browse to the folder mySewnet/Samples/Embroidery/Stitch.
- 4 Switch to Icon View to see thumbnail pictures of the designs in the folder.
- 5 Click the Blanket Stitch Flower embroidery to select it, then click Open to load the design. The flower design appears in the work area.



- 6 With the flower embroidery still selected, click Actions  on the toolbar and choose Copy. Alternatively, choose Edit > Copy or press ⌘C.
- 7 In the Create window  of the Control Panel  click Quilt Block Assistant . Alternatively, choose Assistants > Quilt Block Assistant. The Select Quilt Block Style page appears.
- 8 Select Filled Quilt Block; Inner Embroidery . This will create a filled quilt block with an embroidery in the center.
- 9 Click Continue. The Select Size page appears.
- 10 Look at the Shape pop-up menu. There are nine shapes to choose from. *Note: All of these quilt block shapes can be tessellated — they will fill an area if tiled individually or combined with another shape, with no overlaps or gaps.*
- 11 In the Shape pop-up menu choose Shape 6, a hexagon.
- 12 Ensure that Point to Point is selected in Enter Size, and that "Include a cut line" is selected.
- 13 Set measurement A to 200mm.
- 14 Click Continue and the Load Embroidery page of the assistant appears. The Blanket Stitch Flower can be seen in the Clipboard.
- 15 Click Paste Embroidery. The blanket stitch flower is placed in the preview.

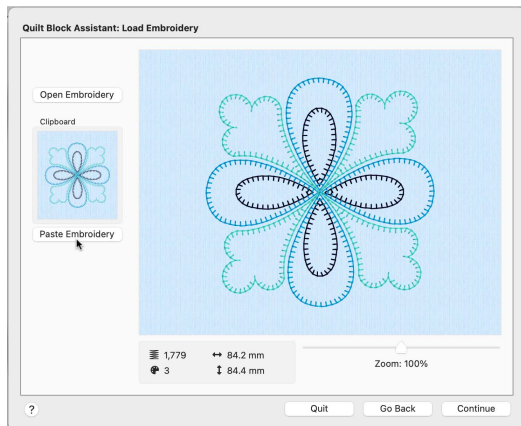

To use embroideries created or loaded in mySewnet™ Embroidery in the Quilt Block Assistant, use Copy and Paste.

Note: The dimensions, number of stitches, and thread colors used in the embroidery are shown below the preview.

- 16 Click Continue. The Adjust Embroidery page appears. The embroidery is placed in the center of the quilt block shape, with a clear margin and blue fill area surrounding it.

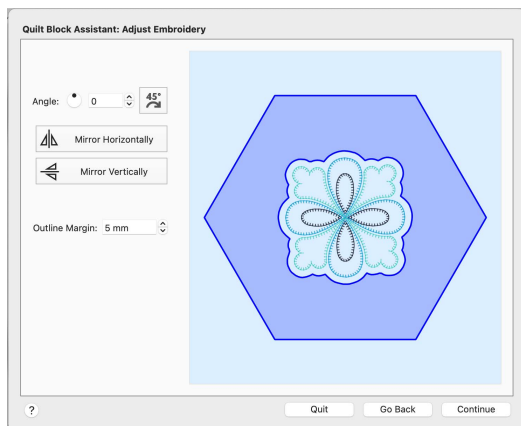



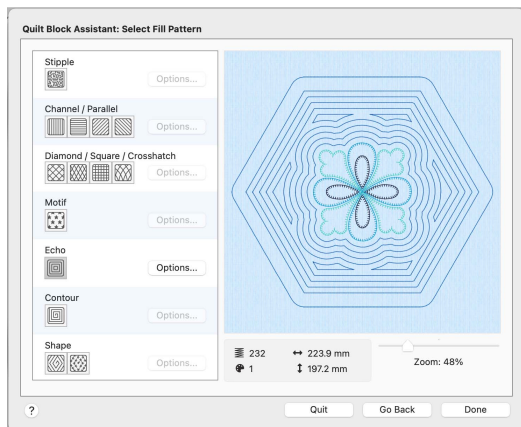

- 17 Click Continue. The Select Fill Pattern page appears. The embroidery is surrounded by an unstitched margin, and the last used fill. The default is Stipple Fill. The Options button is available to change the settings.
- 18 Click Echo . The fill around the embroidery changes to an Echo Fill, emphasizing the blanket flower.

Note: The outer lines in the echo fill follow the outline of the quilt block, while the inner lines follow the outline of the embroidery.





- 19 Click Done to place the finished quilt block in the work area.

Create a Quilt Block with a Central Filled Shape

- 1 In the Create window  of the Control Panel  click **Quilt Block Assistant** . Alternatively, choose Assistants > Quilt Block Assistant. The Select Quilt Block Style page appears.
- 2 Select **Outline Quilt Block; Filled Inner Shape** . This will create a block with a filled shape in the center.
- 3 Click Continue. The Select Size page appears.

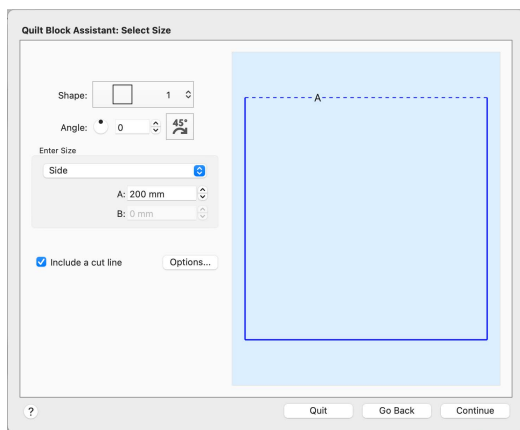
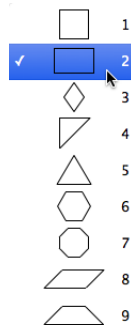
- 4 Look at the Shape pop-up menu. There are nine shapes to choose from.
Note: All of these quilt block shapes can be tessellated — they will fill an area if tiled individually or combined with another shape, with no overlaps or gaps.
- 5 In the Shape pop-up menu choose Shape 2, a rectangle.
In the preview area two sides of the rectangle are shown with a dotted line, sides A (the top) and B (the side).
- 6 In Enter Size, click the up and down arrows in boxes A and B. The rectangle changes shape.
This enables you to set the rectangle shape and size.
- 7 In the Shape pop-up menu choose Shape 1, a square.
Only one side, A, now has a dotted line as all sides are the same size. The box B is now unavailable (dimmed).
- 8 Look at the Enter Size pop-up menu. You can choose from Side and Diagonal, so you can enter the measurements according to the quilt pattern you are piecing.
Note: If you select Diagonal the dotted line 'A' will run diagonally across the center of the square.
- 9 Ensure that Side is selected in Enter Size.
- 10 Set side A to 150mm.
- 11 Position the arrow pointer over box A in Enter Size without clicking. A tooltip shows the measurement in inches, and the minimum and maximum size.
Note: Positioning the arrow pointer over a measurement box shows the alternative measurement. You may also enter the alternative measurement with units of mm or " and it is automatically converted.
- 12 Set A to 200mm. The square is now 200mm wide and high.
- 13 Ensure that "Include a cut line" is selected.



- 14 Click Continue. The Select Shape page appears. Use this page to select the internal shape for the quilt block.
- 15 Look at the Shape pop-up menu. There are 120 shapes to choose from.
- 16 Scroll down the list and select Shape 71, a heart. In the preview the internal shape becomes a heart.
To resize the shape, use the handles on the corners of the box. The Width and Height boxes show the new dimensions.
To change the shape, set Proportional  to unlocked, then move a corner handle or one of the dotted lines.
To move the shape, drag within the box and position the shape as desired.

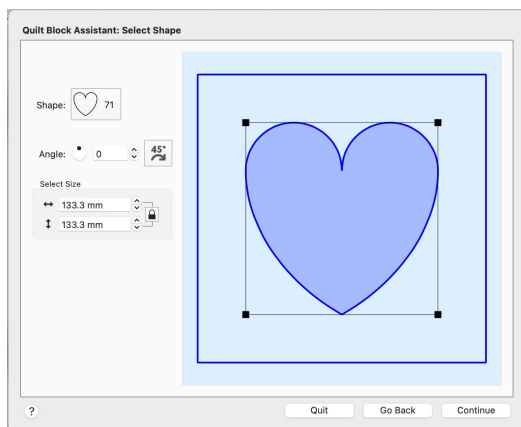
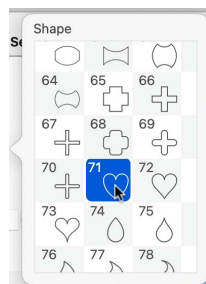

- 17 No adjustment of the shape is required, so click Continue. The Select Fill Pattern page appears. The heart shape is filled with the last used fill.
- 18 Click Motif . The fill pattern changes to stars, and the Options button in the motif area becomes available.
- 19 Click the Options button for motifs. The Motif Fill Properties dialog opens.
- 20 Click the Motif I button. The Motif dialog opens.
- 21 Set the Group to Universal and the Category to General Motifs I.
- 22 Select Pattern 6, a heart in the pattern window.
- 23 Ensure that the motif Height is set to the default value of 8mm.
- 24 Click OK to close the motif dialog.
- 25 In the Gap area of the Motif Fill properties dialog, set Horizontal to 10% and set Vertical to 25%. This will create more space between the hearts in the fill.

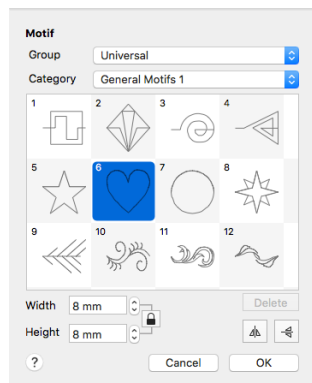

- 26 In Offset, set Horizontal to 50%.
This will alternate the positioning of the hearts.
- 27 Click OK to return to the Select Fill Pattern page.
Use the preview on the Select Fill Pattern page to check your adjustments.
- 28 Click the Options button for motifs again.
- 29 Change the Stitch Type to Triple.
- 30 Set the Horizontal Gap to 10% and the Vertical Gap to 20%.

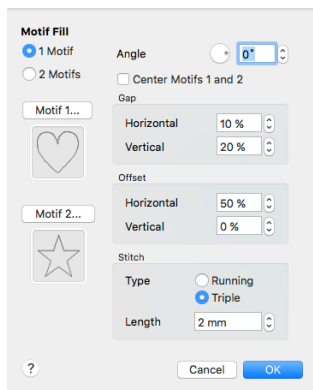

- 31 Click OK to return to the Select Fill Pattern page.

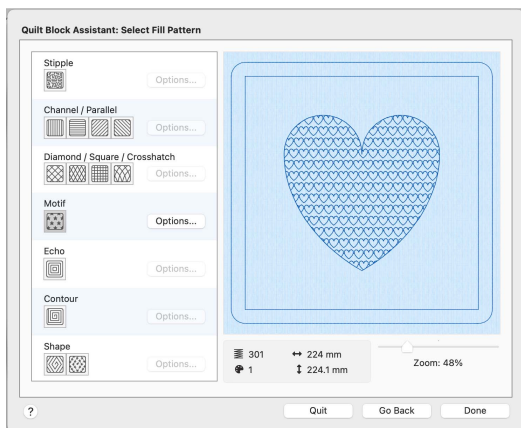

- 32 Click Done. The quilt block is displayed in the design area.

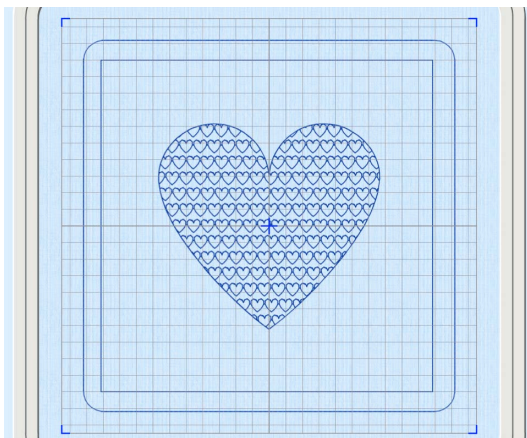

Note: Two rows of stitching around the quilt block show the lines at the edge of the block where the fabric should be cut and folded.

Use the Project-in-the-Hoop Assistant to create an in-the-hoop design using your choice of project type, style and dimensions.



Use the Project-in-the-Hoop Assistant  to create an in-the-hoop design, selecting a project type, style and dimensions. Follow the PDF instructions to stitch out your project.

Project-in-the-Hoop Assistant

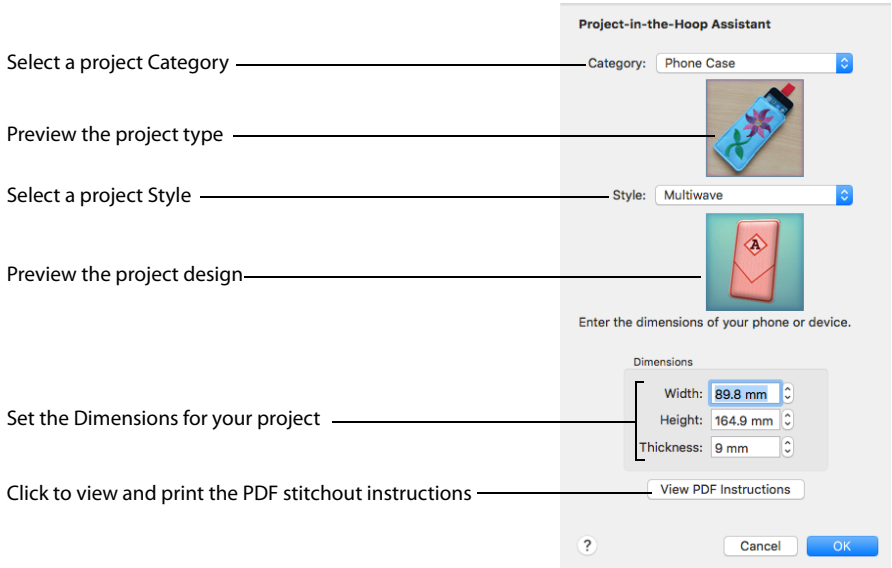

Use the Project-in-the-Hoop Assistant to create an in-the-hoop design.







Open the Project-in-the-Hoop Assistant

- In the Create window  of the Control Panel  click > Project-in-the-Hoop Assistant .
- Choose Assistants > Project-in-the-Hoop Assistant.







Use the Project-in-the-Hoop Assistant

- 1 In the Create window  of the Control Panel  click Project-in-the-Hoop Assistant . Alternatively, choose Assistants > Project-in-the-Hoop Assistant.
- 2 Select a design Category and a Style.
- 3 If required, enter the Dimensions of your project.
- 4 Click the View PDF Instructions button to view and print a copy of the PDF stitchout instructions.

- 5 After you click OK to select the project, read the instructions in the PDF, and view how the project is constructed in the Design Player .
- 6 Then make any desired customizations to the main design in the work area.
Note: Ensure that you change only the decorative embroidery, and not the construction stitching. Preserve the order of the sections of the project.
- 7 Choose Edit > Previous Design () and Edit > Next Design () to step between the sections of the project, or use Reveal Groups  to view the sections in the FilmStrip.
- 8 Change the color of the construction stitching, and the decoration, to suit your fabric.
- 9 Choose File > Save to save your project, and then stitch it out in a suitable hoop, following the instructions.



Create a Phone Case Project

- 1 If required, choose File > New and load an empty work area.
- 2 Click the Hoop button  and set the hoop size to 260mm x 200mm - Universal Large Hoop 3, and set Orientation to Natural. See “Hoop Selection” on page 22.
- 3 Click OK to select the hoop.
- 4 In the Create window  of the Control Panel  click Project-in-the-Hoop Assistant . The assistant opens.
- 5 In the Category pop-up menu, choose Phone Case.
- 6 In the Style pop-up menu, choose Multiwave. The phone case style is displayed.
- 7 Click the View PDF Instructions button. A PDF of the instructions is displayed.
- 8 Scroll through the document to view the instructions, and if desired print or save a copy.
Note: To view the instructions again later, reopen the Assistant, choose the same Category, and click View PDF Instructions.
- 9 Measure the phone, then enter the Width, Height and Thickness of the phone in the number boxes.
- 10 Click OK to load the project into the work area.
Note: The hoop is considerably larger than the design. You can use a smaller hoop.
- 11 Click the Hoop button  and set the hoop size to 240mm x 150mm - Universal Large Hoop 2, with Orientation set to Natural.
- 12 Below the FilmStrip, click Reveal Groups .
Note: The project is created as a Group. Use Reveal Groups to customize part of it.
- 13 Choose Edit > Next Design () until the letter A embroidery is selected.
Note: The thread colors in the Color Select panel in the Design Panel indicate whether a gray structural section, or a red decorative section is selected.
- 14 Control-click the A embroidery, and choose Edit Lettering in the context menu to view the Letter Properties dialog.

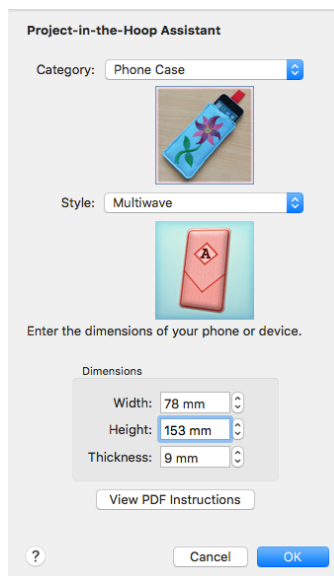

15 In the Letters text box, change the initial to that of the phone's owner.

16 Click the Font, and in the font list scroll to the Modern Category.

17 Select the font Rian 10-30mm. *Note:* To squeeze more letters into the space, you could select a smaller font, and adjust the lettering shape with the Handles menu.

18 Click OK twice to close the Letter Properties dialog.

Note: The pink for the letter is too similar to the color of the other stitching. A darker color would work better.

19 Open the Design window  of the Control Panel .

20 In the Color Select, double-click the pink for the letter to open the Color Selection dialog.

21 Select a stronger color in the dialog, or use the Colors window .

22 Click OK to view the changed color.

23 Choose Edit > Next Design () or the FilmStrip again to select the red MultiWave Fill stitching in the Color Select area.

24 Control-click the stitching, and in the context menu choose MultiWave Fill, and MultiWave Fill 1.

Note: This is the fill for the bottom part of the phone case.

25 In the MultiWave Fill properties dialog, select (check) Use Motifs, then click the Motif button.

26 In the Motif dialog, select a motif Category and Pattern.

27 Reduce the size of the motif to suit the small size of the phone case, then click OK twice to view your changes.

28 Control-click the stitching, and in the context menu choose MultiWave Fill, and MultiWave Fill 2 to select the fill for the top part of the phone case.

29 In the MultiWave Fill properties dialog, select (check) Use Motifs, then click the Motif button.

30 Select a motif Category and Pattern, and set the size as desired. Click OK twice to close.

31 In the toolbar, click Design Player .

32 Play through the design to see how it will be stitched out.

Note: You can also print a worksheet to view the structure of the project.

Choose File > Save to save your project, and File > Export to save it for your embroidery machine, then stitch it out.

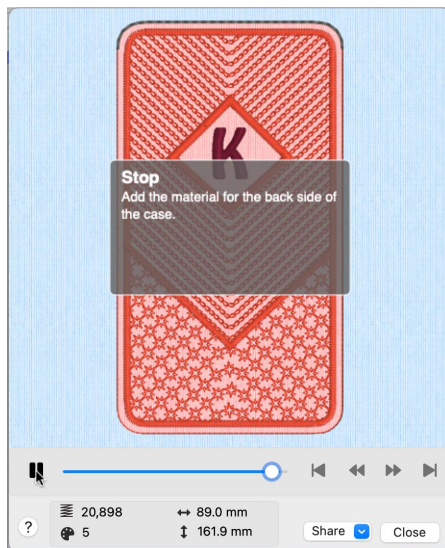
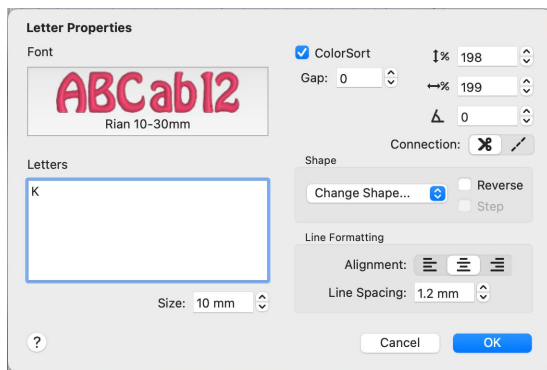

Use the **Word Sculpt Assistant** to create a word design automatically using your choice of outline, words, and fonts.

Use the **Word Sculpt Assistant**  to create a word design automatically. Select or create an outline, and choose colors, words and fonts.



The initial size is set by the hoop. The most recently used values are kept within a session. Information about the outline, words and fonts used is stored in the settings of the embroidery that is created.



Word Sculpt Assistant

Use the **Word Sculpt Assistant** to create a word design automatically. The **Word Sculpt Assistant** opens at the **Select Outline** page.

Open the **Word Sculpt Assistant**

- In the **Create** window  of the **Control Panel**  click > **Word Sculpt Assistant** .
- Choose **Assistants > Word Sculpt Assistant**.

To learn how to	Go to
Create a Word Sculpt embroidery	See “ Create a Running Man Word Sculpt Design ” on page 269.
Adjust the lettering blocks in your word sculpture	See “ Change Template Settings in the Block Menu ” on page 370.

Select Outline

Use the Select Outline page to select a shape for your word design, set its size and angle, choose a stitch type for the outline and adjust its settings.

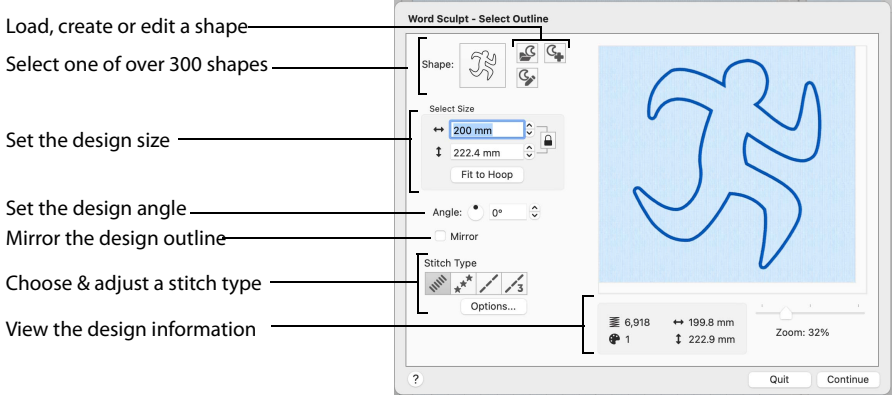

Shape

Choose one of over 300 shapes from the pop-up menu, or load, create or edit an outline shape in mySewnet™ Draw & Paint.

Note: In mySewnet™ Draw & Paint, if your shape has multiple parts, the first closed shape in the FilmStrip will be used. If needed, move the intended shape to the top of the design.

Select Size

Enter the desired size for your design.

Note: The default dimensions will depend upon the shape selected, and the current hoop. The minimum size for a design is 20mm and the maximum size is 2000m.

Angle

Use Angle to change the angle at which the outline shape is created and displayed.

- Enter an Angle from 0 to 359 degrees. The initial setting is 0.
- Alter the Angle by typing a number in the box, or use the up and down arrows to change the number.



Note: Changes in Angle are visible in the preview pane.

Mirror

Select the Mirror checkbox to reflect the design from left to right.

Stitch Type

Select the stitch type for the outline to for the word design:





- Satin Line : see "Satin Line" on page 504.
- Motif Line : see "Motif Line" on page 506.
- Running Stitch : see "Running Stitch" on page 501.

- Triple Stitch : see “Triple Stitch” on page 503.

Stitch Options

- After selecting the type of outline, click the Options button to show and adjust the properties for that outline type. Click OK to finish.

Preview

A preview of the design, and its stitch count , width , height  and number of color blocks  is displayed.

Zoom Bar

Use the Zoom bar to change the view of the picture. Zoom in (drag the slider to the right) to magnify the view. Zoom out (drag the slider to the left) to shrink the view.

When zoomed in, use the scroll bars or swipe to move around.

Continue

Go to the Select Words page.

Select Words

Enter words for the design

Use only capital letters

Use each word once

Set the font size and margin

Use a random variety of fonts

Choose one font for the design

Select a color palette

Set the orientation of the words

Show or refresh the preview

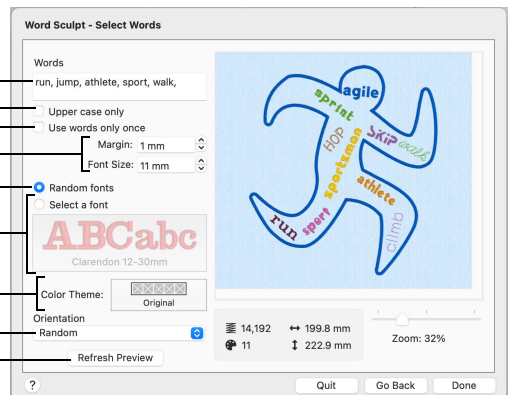

The Select Words page enables you to enter words, and place them inside the outline you selected. Enter the words, select the case, and if they will be used more than once. Choose a font or random fonts, select a color theme, and select the orientation of the words in the design. Use Refresh Preview to view changes in the preview area.

Words

Enter the words or phrases to use in the design, separated by a comma. The words are used in a random order.

Note: Either enter the words in the text box, or copy and paste them in from a text editor.

Upper Case Only

Select this option to use only capital letters for your words.

Note: If a lower case font is selected, the words will use lower case.

Use Words Only Once

Use each word entered only once.

Note: If a particular word is entered more than once, it will be used more than once.

Margin

Set the margin between the words in the design from 0mm to 20mm.

Font Size

Set the size of the font to be used in the design. The initial setting is 12mm.

The fonts that are used will be within their recommended size range. View your fonts in Font Manager  to check the recommended size range.

Note: If a large Font Size and Margin are selected, no words may appear within the design outline, as there may be insufficient space.

Random Fonts

Select the Random Fonts option to use a varying selection of fonts that are available to use at the selected Font Size.

Note: By default the random size range used is from 3mm (the lower end of the recommended size range for fonts) to 12mm (the initial size for a Word Sculpt Assistant font). Any font within this range may be used at the selected Font Size.

Select a Font

Use the Select a Font option to choose a font from the menu.

Note: For best results, use a font whose recommended size range includes the Font Size you selected above.

Color Theme

Use Color Theme to select the colors for your word sculpture. The Original setting will use the default colors for the design outline and the selected fonts. If you select another theme, the fonts and outline will use the colors in that theme.

Note: The available themes are: Original, Rose, Red, Orange, Yellow, Green, Teal, Light Blue, Blue, Purple, Pink, Gray, Cold, Warm, Grass, Earth, Lipstick, Primary, Complementary 1, Complementary 2 and Complementary 3.

Orientation

Use Orientation to select the positioning of the words in your sculpture. Choose from:

- Random
- Horizontal
- Vertical
- Horizontal and vertical
- Diagonal
- Horizontal, vertical and diagonal

The default setting is Random.

Refresh Preview

Refresh Preview updates your design using any new settings, and changes the random distribution of the words in the sculpture.

- Click Refresh Preview repeatedly to view different arrangements of the words in the design.

Design Information

The design information boxes show the dimensions (Width ↔ and Height ↓), Stitch Count ☰, and number of colors 🎨 for the embroidery. The design information may change when the embroidery is exported, depending on the Optimize for Sewing Options.

Done

Click Done to close the assistant.

Word Sculpt Assistant Examples

Create a Running Man Word Sculpt Design

- 1 If required, choose File > New.
- 2 In the Create window of the Control Panel click Word Sculpt Assistant. The Select Outline page of the Word Sculpt Assistant appears.

Note: A large hoop is best when creating a word sculpture.

- 3 Click the Shape button to view the Shape list. There are over 300 shapes to select from. You can also load, create or edit a shape.
- 4 In the Shape pop-up list scroll down to the People category, and select the shape Running 1.

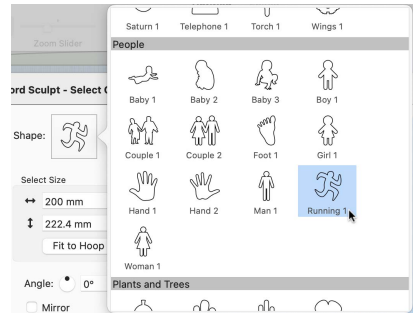

Note: The size of the design is set by the currently selected hoop. There is no need to change the settings in Select Size for this design.

- 5 Ensure that Angle is set to 0, and that Mirror is not selected.

Note: Use Angle and Mirror to adjust the position of the outline.

- 6 In Stitch Type ensure that Satin Line is selected.

Note: For a different effect, you could choose Motif Line, and click Options to select a different motif and its settings.

- 7 Click Continue and the Select Words page of the assistant appears.

- 8 In the Words text box, enter the words or phrases to use in your design, separated by a comma. You may find it easier to create the list in a text editor and paste it in.

Note: Not all of your words may be used. Enter a word twice in your list if you want it to be frequent in the design.

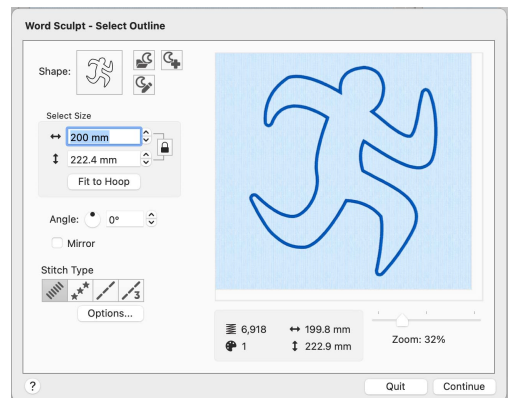

- 9 Deselect Upper case only to use upper and lower case letters.
- 10 If desired, select Use words once only if you do not want words repeated.
- 11 Set Margin to 1mm to place the words close to each other.
- 12 Reduce Font Size to 8mm to enable more words to fit into the running man outline.
- 13 Ensure that Random fonts is selected.

Note: Random fonts uses a variety of fonts recommended for the selected Font Size. For example, both Antonia 10-20mm and Arial 08-14mm may be used if the Font Size is set to 11mm.

- 14 Click the Color Theme button and ensure that Original is selected in the pop-up menu. The outline and words will use their original colors.

Note: Use one of the other Color Themes to set the design to variants of the same color.

- 15 In Orientation ensure that Random is selected.

For a different effect, you could select Horizontal and Vertical or one of the other options.

- 16 Click the Refresh Preview button to use your updated settings.
- 17 Click Refresh Preview again. The arrangement of the words and the number of words used changes.
- 18 Change the settings and use Refresh Preview until you are happy with the results.

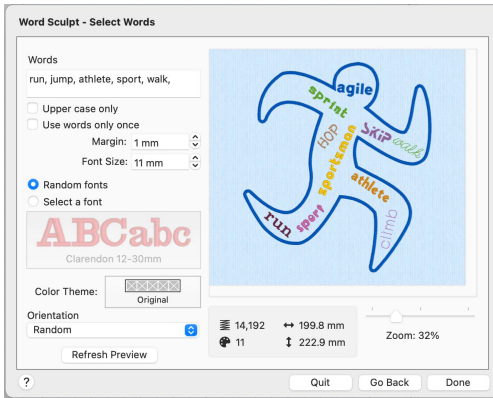

- 19 Click Done to place the design in the work area. Save this original version, if desired.

Note: The design is loaded as a Group, and each word is a lettering Block with Curve line types at Top and Bottom, and Constraint set to Free. You can mould each Block to almost any shape you wish.

- 20 At the bottom of the FilmStrip, click Reveal Groups , then click the yellow handle on one of the lettering Blocks. You can see the settings for the Block.

Note: For more information on adjusting lettering Blocks, see *Creating Lettering in the mySewnet™ Embroidery Reference Guide* or *Help*.

- 21 Drag the handles on the block to mold it to the desired shape.

Note: Choose Edit > Previous Design (⌘ ←) and Edit > Next Design (⌘ →) to move between the designs in the Group.

- 22 To change the font in a lettering Block, Control-click the Block and select Properties in the Context menu.

Note: If you want to mould a lettering Block to a larger size, a different font may look better. Search by Size to find a font in a suitable size range.

- 23 To add a word to the design, choose Edit > Copy (⌘C) then Edit > Paste (⌘P) to copy and paste one of the words, and then move it to the desired position.

- 24 Control-click the new word, and in the Letter Properties dialog change the text and font. Click OK.

- 25 In the Color Select area on the Design Panel, click the thread color and set it to match the theme.

- 26 Mold the new word to shape.

Add words to your design and mold them to shape, then Save your finished design.

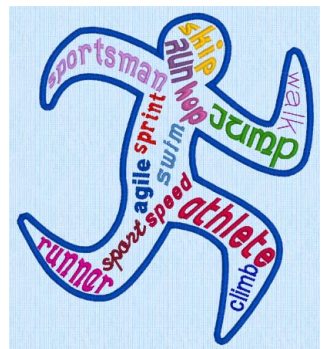
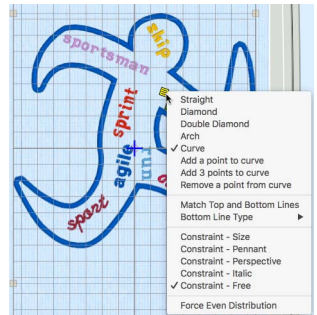



Use the Spiro Assistant to create intricate spiral designs in multiple colors, using Running, Double or Triple stitch lines.

Spiro Assistant

Use the Spiro Assistant  to create intricate spiral designs in multiple colors, with Running, Double or Triple stitch lines.

Open the Spiro Assistant

- In the Create window  of the Control Panel  click Spiro .
- Choose Assistants > Spiro.

Using the Spiro Assistant

Use the sliders to create your own unique spiral design. Select a number of petals (lobes). Add colors and lines to make your design more complex. Select a line type for your stitching from Running, Double and Triple stitch. Click OK to place your design on the work area.

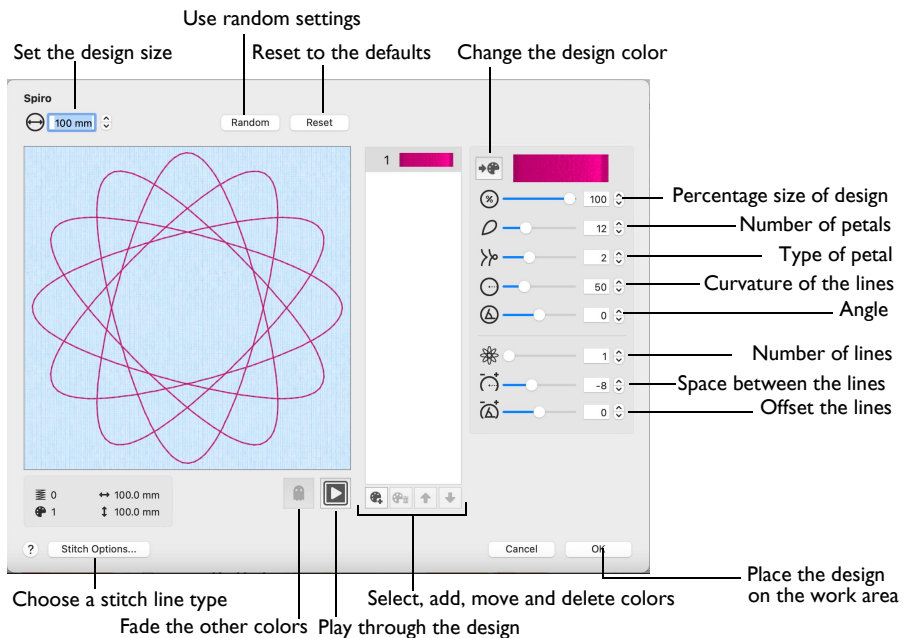

Drag the sliders to create a unique design.

Note: Your previous design will still be available if you re-open Spiro during the same session.

Maximum Diameter

Use Maximum Diameter  to set the maximum size for your design. Use this to fit it to your chosen hoop, or to set the size of a spiral design element. Enter a number, or use the up and down arrows.





Random and Reset

- Click the Random button to show a different preset Spiro design for you to adjust.
- Click Reset to return to the original default design.

Note: If you adjusted the existing design, a message appears: "This will lose any changes. Do you want to continue?" Click OK to start a new design, or Cancel to save your design.

Add, Move and Delete Colors

Note: Select a color in the Color Select area to adjust the settings for that part of the spiral design.

Use Add Color  to add a new color spiral to your design, and use Remove Color  to delete the selected color from the design. Use Move Up  and Move Down  to change the position of colors within the design.

Thread Color

Use Thread Color  to change the selected color in the Color Selection dialog. See "Color Selection Dialog" on page 79.

Sliders

Use the sliders to transform the selected spiral design, or enter a number in the box.

Percent of Diameter

Use the Percent of Diameter  slider to set the size of the selected spiral design as a percentage of the value that you set in Maximum Diameter.

Note: Use this to create a design within a design of a different color.

Number of Petals

Use Number of Petals  to choose the number of petals for your design.

Petal Type

Use the Petal Type  slider to select the configuration of the petals for your design.

Note: The number of Petal Types can vary considerably, depending on how many petals are in your design.

Curvature

Use Curvature  to change the curvature of the lines towards the center of the design.

Note: The higher the Curvature, the more the lines will curve towards the center of the design, and then away when the center is reached.

Rotation

Use Rotation  to control the angle of the petals within the design. This can be used to offset one color from the next.

Multiple Line Settings

Use the following sliders to change the settings in a multiple line design.

Number of Lines

Use Number of Lines  to set the number of lines using the path described by the settings above.

Note: Use Number of Lines to create a braided effect.

Curvature Spacing

Use Curvature Spacing  to adjust the distance from each other of the lines chosen with Number of Lines, and from the center of the design.

Rotation Offset

Use Rotation Offset  to rotate the design around the circle, so as to increase or decrease the overlap for the selected lines.

Stitch Options

Click the Stitch Options button to select a line type for your spiral design. See “Stitch Options” on page 276.

Ghost Mode

Use Ghost Mode  to Fade the stitch colors that you are not adjusting.

Design Player

Use Design Player  to play through the design. See “Design Player” on page 73.

Create a Spiral Design



- 1 Click the Create tab.
- 2 In the Create tab, click Spiro . The assistant opens.

Note: If you previously used Spiro in this session it will open with the design that you created, otherwise the default settings are used. Click Reset to return to the defaults.

- 3 At the top left of the Spiro dialog note that Maximum Diameter  is set to 100mm. This is the width of the design.

- 4 Look at the panel on the right, noting the default settings.

The top setting Thread Color  enables you to change the color of the selected line. Use Percent of Diameter  with multiple colors.

- 5 Drag the Number of Petals  slider slowly to the far left, to the number 2. Petal Type  below is set to 1, now the only choice. The number of options for a setting depends on the other settings used. If Number of Petals is set at 50, 19 Petal Type options are available.

- 6 At the top, click Reset. There is a warning: "This will lose any changes. Do you want to continue?"

- 7 Click OK to return to the default settings.

- 8 Leaving the Number of Petals at the default 12, drag Petal Type  so as to see all of the four variants, finishing with setting 3.

- 9 Drag the Curvature  slider to the right from 50 to 73 (a flower), to 90, and then to 200. Move slowly so as to see the changing patterns. You could also enter the number into the number box for a precise value.

- 10 Drag Rotation  a small distance to the left or right. The whole design rotates.

- 11 Set Number of Lines  to 3. The single line for the design is replaced by three parallel lines.

- 12 Drag Curvature Spacing  (now -8) to the right to 0. The three lines merge. There is zero space between the lines.

- 13 Drag Curvature Spacing further right to 20.

- 14 Then drag Rotation Offset  to the right very slowly. The lines rotate relative to each other.

- 15 Drag Rotation Offset to 15 to complete the first color for your design.

- 16 Below the color select box, click Add Color .

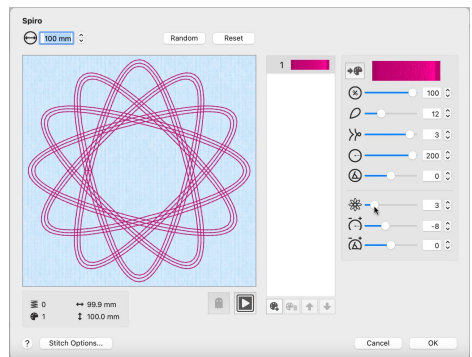
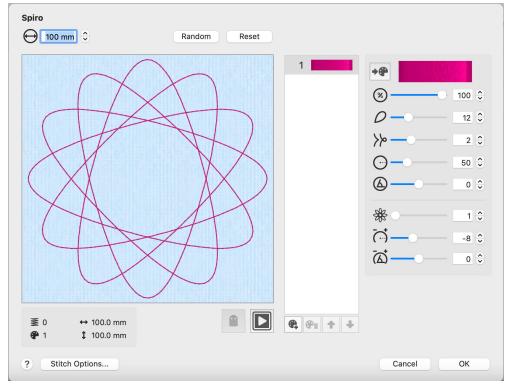

- 17 In the Color Selection dialog, choose a yellow and click OK. There are now two colors in the color select, and the design is yellow.

For more information on color selection, see “Color Selection Dialog” on page 79.

- 18 Drag the Percent of Diameter (⊗) slider to 75% (from 100%). The new yellow design becomes smaller, revealing your original red design underneath. The new color initially uses the same design as the color above. The original color is faded.

- 19 Click Ghost Mode (👤). The red threads are now their original brightness.

Ghost Mode enables you to focus on the thread color that you are currently adjusting.

- 20 Use the sliders to adjust your second design. You can add more colors, or delete colors, and move colors up and down the color (stitch) sequence.

- 21 Click Stitch Options.

- 22 In the Stitch Options dialog, choose Triple Stitch.

- 23 Set Stitch Length to 2mm.

Note: Use Maximum Gap to Trim to use Trims or stitches between your stitch lines. For example, set 2mm or 3mm to use trims between spiral lines rather than stitches.

- 24 Click OK to close Stitch Options.

- 25 In the Spiro Assistant dialog, click Design Player (▶).

For more information on Design Player, see “Design Player” on page 73.

- 26 Click Play (▶) to play through the stitches in your design, and click Cancel to finish.

- 27 In the Spiro Assistant dialog, click OK to place the design on the work area.

- 28 Click Settings (⚙️) in the Notes and Settings area of the Design Panel.

- 29 Click Edit (🗨️). The Settings dialog opens with the complete settings for your design. You can use these settings to recreate the design in Spiro Assistant. Choose File > Print to print a worksheet with these settings.

- 30 In the Create tab, click Spiro (🌀) again. The Spiro Assistant opens with your settings preserved. If you previously used the Spiro Assistant in a session it will open with the design that you created. If you close mySewnet™ Embroidery, the default settings will be used the next time you open Spiro Assistant.

- 31 Click Random. The warning message about losing settings is displayed.

- 32 Click OK to view a randomly created Spiro design.

To add a color within a Spiro design, use Insert Color Command (🎨) in the Modify tab or in mySewnet™ Stitch Editor to add a Color Change. See “Insert Color Change” on page 135.

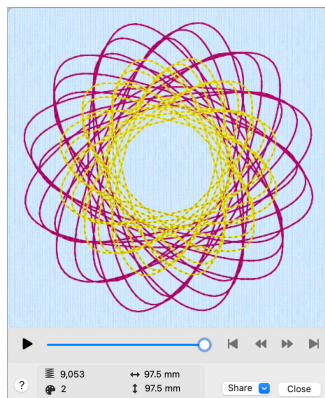
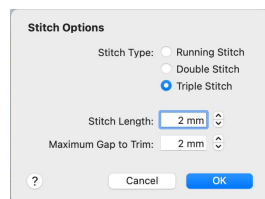
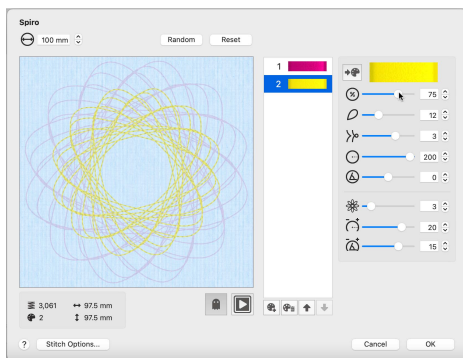

To change the line type to a Motif Line, open the Spiro Assistant design in mySewnet™ Stitch Editor and in the Object tab select the line, then use Convert to change the line to use the motif of your choice.

Use the Morphing tools in mySewnet™ Stitch Editor to change your spiral into a swirl!

Stitch Options

Use the Stitch Options dialog to select a line type for your spiral design.

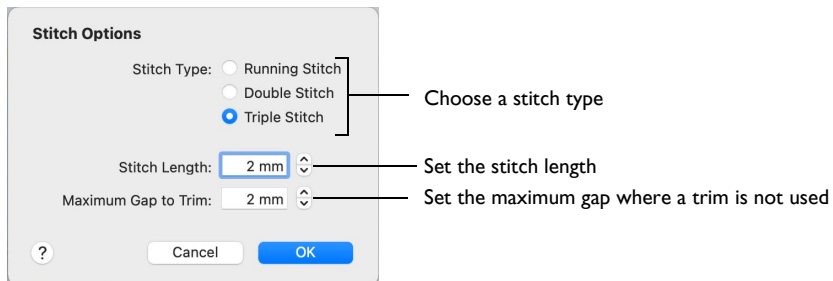

Use the PhotoStitch Assistant to create new embroideries automatically from photographs.

Use the PhotoStitch Assistant  to create embroideries automatically from photos. Acquire pictures from a digital camera or scanner, or browse to a photo on your computer.

Create a color, sepia, monochrome or color tile embroidery, or a linear embroidery using a single thread. Remove the picture background to enhance the subject.

The PhotoStitch Assistant works best with photos in which the person's face is well defined, and the background color, if used, contrasts well with the face and hair.

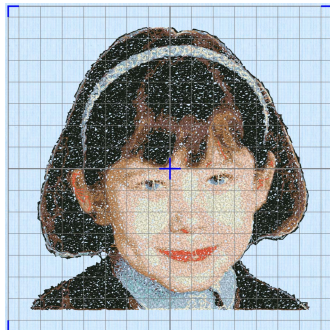

After creating a PhotoStitch embroidery, use the Frame and Border features to surround the embroidery.

Color PhotoStitch Embroidery

Create a PhotoStitch embroidery from a color photo, generating a randomized pattern of stitches, using multiple threads for a full color result.

Color PhotoStitch works best when using pictures with a good color range, and a well defined, differently colored, background.



Sepia PhotoStitch Embroidery

Create a sepia embroidery from an old sepia or black and white picture, or create a sepia effect embroidery from a color picture, to give a heritage look, similar to old photos. PhotoStitch generates a randomized pattern of stitches, using sepia colored threads.

Sepia PhotoStitch works best when using pictures with good contrast, and a well defined background.



Monochrome PhotoStitch Embroidery

Create a PhotoStitch embroidery from a black and white photo, generating a randomized pattern of stitches, using threads in grayscale color ways.

Monochrome PhotoStitch works best when using pictures with good contrast, and a well defined or transparent background.



Color Tile PhotoStitch Embroidery

Create a PhotoStitch embroidery from a color photo, generating small blocks of stitches in varying shapes with a tiled effect, using multiple threads for a full color result. PhotoStitch automatically generates tiled blocks of stitching in the selected colors. Select from diamond, square or hexagon shaped blocks.

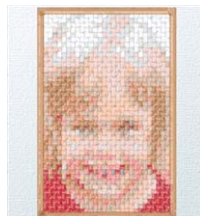

The color tile method is ideal for achieving artistic, impressionistic embroideries. Color Tile PhotoStitch Embroidery works best when using pictures with good contrast, and a well defined or transparent background.

Linear PhotoStitch Embroidery

Create a PhotoStitch embroidery from a color or monochrome photo, generating a linear pattern of stitches, or a Maze or Spiral effect, using one thread for a single color result. There are six effects available.

Linear PhotoStitch works best when using a photo with good contrast on the face, and without areas of deep shadow.







PhotoStitch into Hoop

Use the PhotoStitch into Hoop option to create a new embroidery in the PhotoStitch Assistant that is a best-fit to the currently selected hoop.

Depending on the shape of the embroidery, it will fit in the hoop vertically and/or horizontally. When the new embroidery is saved, it is included in the project with any other embroideries that are on the mySewnet™ Embroidery screen.

- In the Create window  of the Control Panel  click PhotoStitch  > PhotoStitch into Hoop.
- Choose Assistants > PhotoStitch > PhotoStitch into Hoop.



Use PhotoStitch into Hoop

- 1 If desired, click Hoop  and choose a different hoop size before using PhotoStitch into Hoop.
- 2 In the Create window  of the Control Panel  click PhotoStitch  > PhotoStitch into Hoop. Alternatively, choose Assistants > PhotoStitch into Hoop.





- 3 Select a photo to use for the embroidery.
- 4 Step through the rest of the PhotoStitch Assistant.
When you finish, the new embroidery is in the center of the hoop.
- 5 If desired, add a frame or border to the PhotoStitch. See “Frames, Borders & Underlines” on page 445.
- 6 Use Save, then Export to keep the new embroidery.

PhotoStitch into Rectangle

Use the PhotoStitch into Rectangle option to create a new embroidery in the PhotoStitch Assistant that is a best-fit to a rectangular area you draw on the mySewnet™ Embroidery screen.

- In the Create window  of the Control Panel  click PhotoStitch  > PhotoStitch into Rectangle
- Choose Assistants > PhotoStitch > PhotoStitch into Rectangle

Use PhotoStitch into Rectangle

- 1 In the Create window  of the Control Panel  click PhotoStitch  > PhotoStitch into Rectangle. The mouse pointer changes to the draw rectangle pointer .
- 2 Drag to draw a rectangle of the desired size on the work area. When you release the mouse button, the Choose Picture page of the PhotoStitch Assistant appears.
If the rectangle is wrong and you wish to try again, click Cancel when the PhotoStitch Assistant appears. Then click PhotoStitch into Rectangle again.
- 3 Choose a picture.
- 4 Step through the rest of the PhotoStitch Assistant.
When you finish, the new embroidery is placed where you drew the rectangle, and will fit the rectangle proportionally, depending on the picture shape.
- 5 If desired, add a frame or border to the PhotoStitch. See “Frames, Borders & Underlines” on page 445.
- 6 Use Save, then Export to keep the new embroidery.

Note: When the new embroidery is saved, it is combined with any other embroideries that are on the mySewnet™ Embroidery screen.

Selecting and Editing Pictures

In many cases the autolevel, cropping and background removal features in the PhotoStitch Assistant will be all that you need when editing photos to make PhotoStitch embroideries.

If you wish to modify a picture further before using it in the PhotoStitch Assistant, you will need to use a picture editor such as Preview. Adjust your picture, save it with a new name, then use the new picture in the PhotoStitch Assistant.

Note: It is recommended to keep your original picture in case you wish to adjust it again with different options.

General Considerations

The PhotoStitch Assistant is most easily used with photos in which the person's face is well defined, and the background color, if used, contrasts well with the face and hair.

Removing the background can not only remove objects that draw attention from the subject of the picture, but can also enable Autolevel to enhance the color.



Before tidying: there are unwanted items in the background of the picture



After tidying: the building is now the main point of focus

It can also create an embroidery with a much lower stitch count, for ease of stitching.





For PhotoStitch, best results may be obtained where the background is almost completely removed. Removing the heavily contrasting background colors may bring out subtle color variations in the person's features.

Cropping Pictures

Use your picture editor or the Rotate and Crop Picture page to crop the picture to approximately the desired proportions.

Note: To obtain more detail on an individual's face it is often helpful to crop so that only the head and part of the shoulders are shown.

Removing Backgrounds

Use Flood Erase  to remove an evenly colored background. If the photo has a graduated background, such as a cloudy sky, use Flood Erase repeatedly, followed by cleaning with the Large Eraser  to remove remaining specks. Very detailed backgrounds with varied coloring, such as a street scene, are best removed with the Large , Medium  and Small  Erasers.

If the face or hair are the same color as the background, Flood Erase may remove them as well.

To prevent this, break the area into two parts with the Small Eraser , then remove the part that you don't want.



The face is the same color as the background, so Flood Erase removes part of it



Two short lines drawn with the Eraser separate the face from the background, so it will no longer be removed

Note: Alternatively, use the editing features in mySewnet™ Draw & Paint, or use the Instant Alpha and Smart Lasso features in the Select popup menu in Preview to remove the picture background. For details, see the topic "Extract an image from its background" in the Preview Help.

A plain, well contrasted background is easy to remove in a picture editor, for example a picture taken against a blue sky, or a brightly painted wall. If the picture was taken against a patterned background, the background color may blend in with the person's hair. This type of background may take a little longer to remove.

Improving Contrast and Color

Autolevel improves the brightness and contrast in most photos, and can be used to bring out the color in underexposed pictures.

Note: Occasionally Autolevel does not improve the appearance of a picture, and may need to be switched off.

Alternatively, use the Effects options in the Paint window of mySewnet™ Draw & Paint, or other graphics apps to alter the color balance in your picture. For example, increase saturation to enhance the intensity of colors, add sharpness to a slightly blurred picture, or use highlights to bring out detail.

Enhancing Details

The significance of details in a picture is dependent on the overall size of the picture after it is cropped. Cropping the picture may bring out the required detail, as may increasing the size of the embroidery.

Even so, very small details in a picture may sometimes be ignored. To enhance these details, select Enhance Detail in the Choose Thread Color page of the PhotoStitch Assistant.

Note: The effect of Enhance Detail varies with each picture, and it is always off by default.

Photos for Color PhotoStitch

A wide range of picture types are suitable for creating a Color PhotoStitch embroidery. The primary factor, however, is to use pictures where the face is well defined, especially the eyes, and the color is good.

Note: An imperfect photo can still make a very good PhotoStitch using Autolevel and Remove Background, or individual color options in a picture editor such as mySewnet™ Draw & Paint.

A plain, well contrasted background will be easy to remove, for example a picture taken against a blue sky, or a brightly painted wall. If the picture was taken against a patterned background, the background color may blend in with the person's hair. This type of background may take a little longer to remove.

Photos for Sepia and Monochrome PhotoStitch

When using old sepia or monochrome pictures for a sepia or monochrome PhotoStitch, choose a photo with good contrast and detail. A plain and well defined background is easier to remove.

Note: To improve definition and contrast on old photos, temporarily remove the photo from its frame, and use a high resolution when scanning it. Where possible, avoid grainy prints. A scan from the negative may work better.

When using color photos for a sepia or monochrome PhotoStitch, choose a photo with good contrast and a well defined background, or one that can be easily removed.

Note: A picture with good contrast, but poor color, may work well as a sepia or monochrome PhotoStitch.

Photos for Color Tile PhotoStitch

Use a strong image with contrasting color areas for a Color Tile PhotoStitch embroidery, as fine details and color changes will probably not show. Use a well defined photograph with varied areas of color.

The color tile method is ideal for achieving artistic, impressionistic embroideries.



Note: A slightly blurred picture with good color areas may make a good tile embroidery.

Photos for Linear PhotoStitch

Pictures for linear, and linear artistic, PhotoStitch embroideries work best when they have strong contrast on the facial features, and no areas of shadow on the face.

Note: Photos with face to camera tend to work better than those taken from the side, as the other side of the face is in shadow. Also, a pale background is often better than a dark background. Try removing the background before making the PhotoStitch.

Use the PhotoStitch Assistant to Create a PhotoStitch Embroidery

- 1 In the Create window  of the Control Panel  click PhotoStitch Assistant  > PhotoStitch into Hoop.
- 2 The PhotoStitch Assistant opens at the Choose Embroidery Type page.
- 3 Select one of the following embroidery types:
 - Color PhotoStitch Embroidery
 - Sepia PhotoStitch Embroidery
 - Monochrome PhotoStitch Embroidery
 - Color Tile PhotoStitch Embroidery
 - Linear PhotoStitch Embroidery

In this example, a Linear PhotoStitch Embroidery and a Color PhotoStitch Embroidery are used.

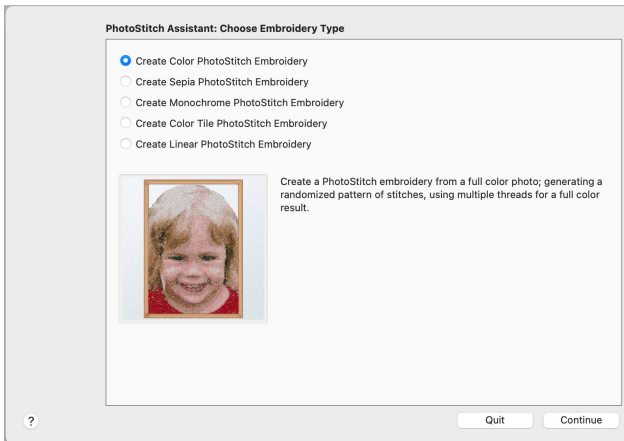

- 4 Click Continue. The Choose Picture page appears.
- 5 Click the desired option from:
 - Select File to select an existing picture file.
 - Other Sources to paste or to obtain a picture directly from a scanner or camera, including a MacBook® integrated camera.
 - Create New Picture or Edit Picture to create or edit a picture in mySewnet™ Draw & Paint.
- 6 In the Open dialog, browse to your photo.

7 Click Open to load the photo into the preview area.

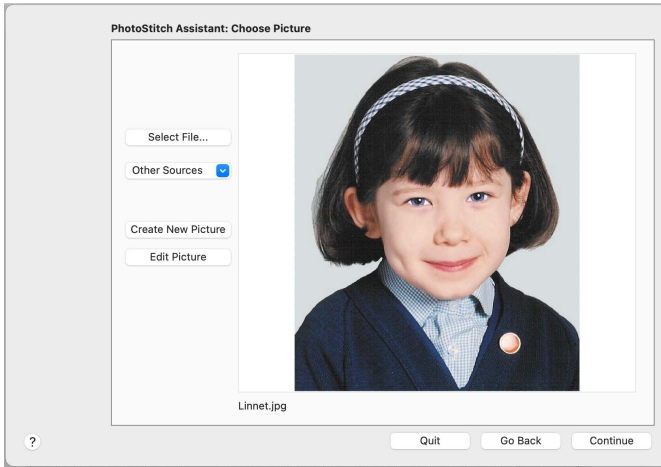

8 Click Continue. The Rotate and Crop Picture page appears.

9 If required, rotate the picture to any angle from 0 to 359 degrees. This can be useful when straightening scanned pictures.

10 If required adjust the crop lines to select the desired area of the picture. Click Automatic to start again.



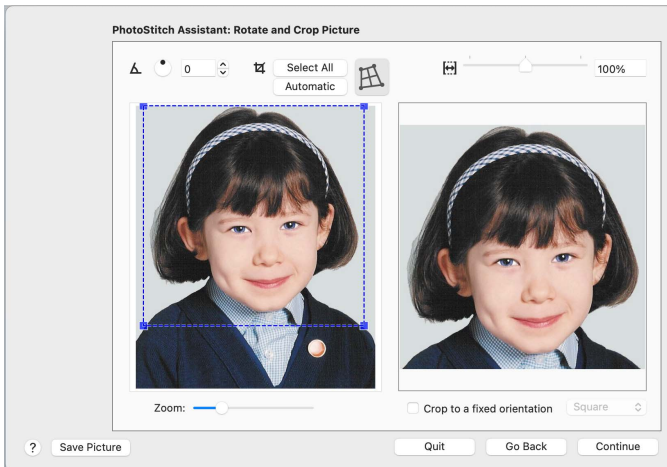

- Hold the Shift key while dragging to resize the rectangle proportionally.
- Hold the Option key while dragging to resize the rectangle without moving its center.

Note: The gray rectangular lines show crop size. Drag anywhere inside the crop box to move it.



Alternatively, crop to a fixed orientation, selecting from square, portrait and landscape.

11 Click Continue. The Remove Background page appears.

12 Use Flood Erase  to remove adjacent areas with a similar color. Use the Large , Medium  and Small  Erasers to 'wipe out' background areas.

Use Undo to reverse actions, and Reset to go back to the original picture.



- 13 Click Continue. The Picture Options page appears.
- 14 Autolevel is initially enabled. It adjusts brightness and contrast automatically. Deselect it if the colors appear distorted.
- 15 To remove the red eye effect caused by flash photography, select Red Eye Removal  and draw an ellipse around the affected area.
- 16 Increase saturation to make colors more intense, for example to make pale skin tones appear 'warmer'.

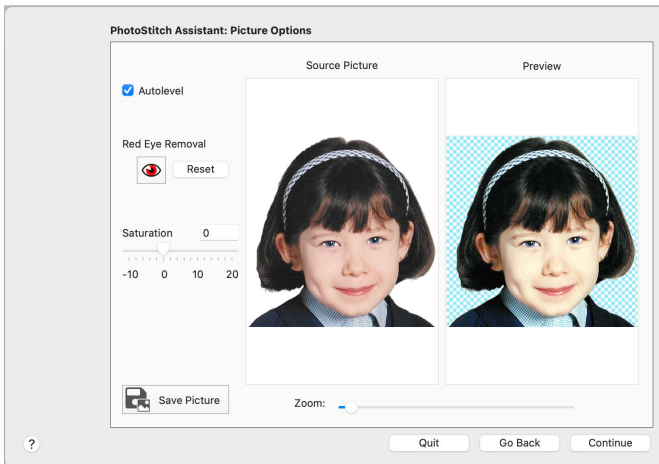

Note: Save the picture if desired, in order to adjust the project later.

- 17 Click Continue. The Design Size page appears.

18 Specify the size of your PhotoStitch. The size changes proportionally.

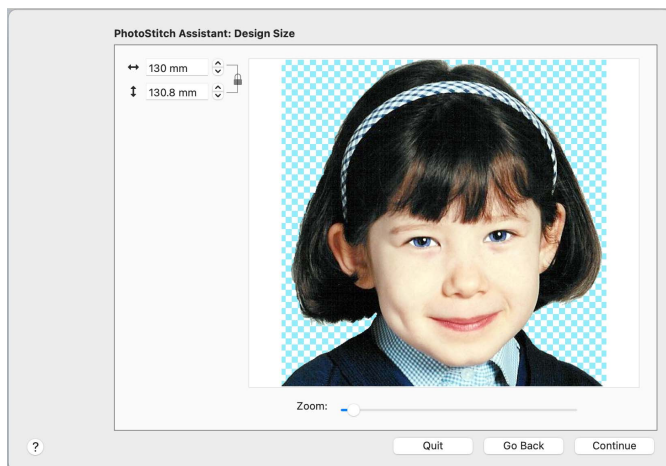

- 19 Click Continue. If Linear PhotoStitch Embroidery was selected in the Choose Embroidery Type page, the Choose Thread Color page appears.

Note: This page displays the number of stitches in the embroidery, its height, width, and the total number of color changes.

- 20 To change the thread color, click Change Color , then select a new color in the Color Selection dialog.
- 21 Select an artistic effect from the pop-up list. The available options are Linear, Spiral and four Maze effects.

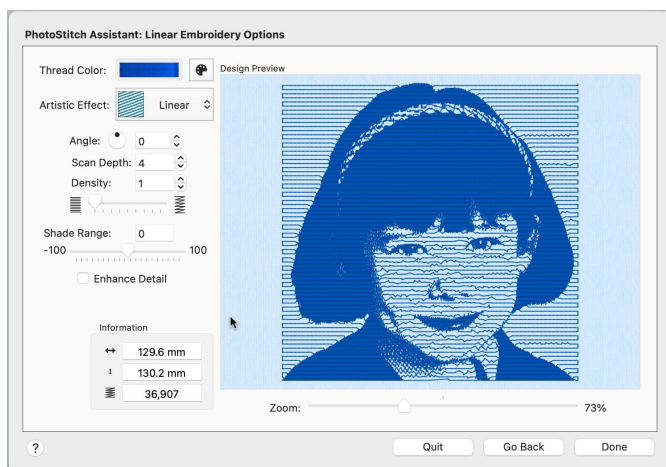

- 22 Select Enhance Detail to bring out detail in the picture, for example in a photo where the face is clear, but the contrast is poor.

Note: Scan Depth refers to the distance between the lines that produce an embroidery from a picture. The lower the Scan Depth figure, the finer the detail in the embroidery, and the more stitches produced.

Note: Density changes the density of the stitching along each line, where 1 is the standard default density and 40 is the most open, with the fewest stitches.

23 Click Done to close the assistant.

Creating a Color PhotoStitch

24 In the Choose Embroidery type page, select Color PhotoStitch Embroidery and click Continue to prepare your picture. After editing your picture, the Choose Thread Colors page appears.

25 Adjust the number of colors with the arrows in the Color Selection box, or type in the required number of colors.

26 Click Apply to update the colors list and preview.

27 To change a particular thread color, select the color, click Edit Selected Color, then select a new color in the Color Selection dialog. See “Color Selection Dialog” on page 79.

28 Add an extra color from the source picture by clicking Pick New Colors, then selecting the color with the eye-dropper pointer . The nearest matching thread is added to the list.

Note: Remove the selected color from the list with Delete Selected Color, or all colors in the list with Delete All Colors. Go back to the original color list with Reset.

Delete All Colors enables you to control the exact colors used. You can delete all colors, then select new colors with Pick New Colors.

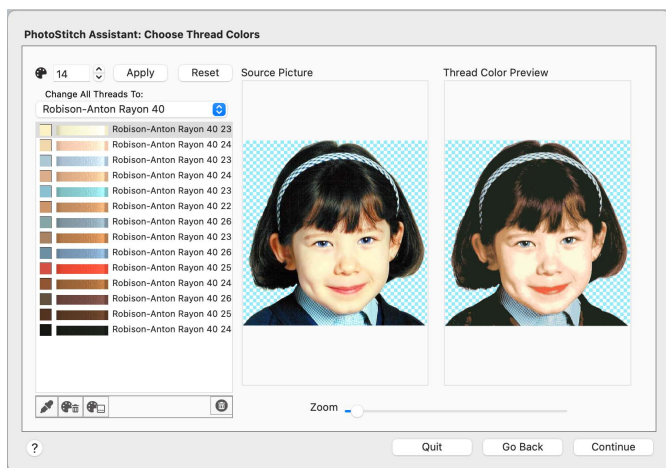

29 Click Continue. The PhotoStitch Embroidery Options page appears.

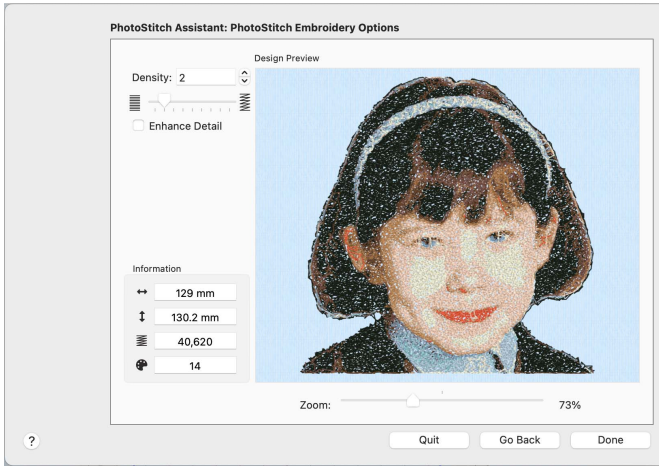

Note: If the photo is large, you may receive a warning about the time taken to create the embroidery.

This page displays the number of stitches in the embroidery, its height, width, and the total number of color blocks.

- 30 Use the slider to adjust the Density of the stitching.
- 31 Select Enhance Detail to bring out detail in the picture, for example in a photo where the face is clear, but the contrast is poor.
Note: Enhance Detail does not change the colors used, it affects the way that those colors are used.
- 32 Click Done to close the assistant. The embroidery is placed in the work area.
- 33 If desired, add a frame or border to the PhotoStitch. See “Frames, Borders & Underlines” on page 445.

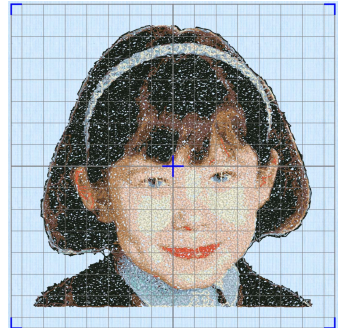

Choose Embroidery Type

Create a full color embroidery

Use monochrome or sepia

Use a color tile effect

Use a single thread to create a single color embroidery

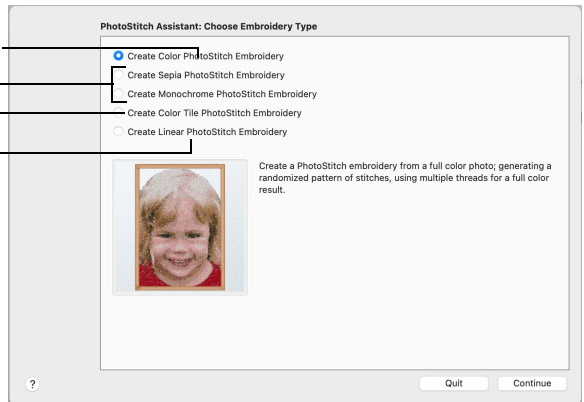

Use the Choose Picture page to select the type of PhotoStitch embroidery.

Color PhotoStitch Embroidery

Create a PhotoStitch embroidery from a color photo. The PhotoStitch Assistant automatically generates a randomized pattern of stitches, using multiple threads for a full color result.

Color PhotoStitch embroideries work best when using pictures with a good color range, and a well defined, differently colored or transparent, background.



Sepia PhotoStitch Embroidery

Create a PhotoStitch embroidery from a colored or sepia photo. The PhotoStitch Assistant automatically generates a randomized pattern of stitches, using sepia colored threads for a heritage effect similar to old photos.

Sepia PhotoStitch embroideries work best when using pictures with good contrast, and a well defined or transparent background.



Monochrome PhotoStitch Embroidery

Create a PhotoStitch embroidery from a photo. The PhotoStitch Assistant automatically generates a randomized pattern of stitches, using thread colors in grayscale color ways.

Monochrome PhotoStitch embroideries work best when using pictures with good contrast, and a well defined or transparent background.



Color Tile PhotoStitch Embroidery

Create a PhotoStitch embroidery from a color photo, generating small blocks of stitches in varying shapes with a tiled effect, using multiple threads for a full color result. PhotoStitch automatically generates tiled blocks of stitching in the selected colors.

Select from diamond, square or hexagon shaped blocks.

The color tile method is ideal for achieving artistic, impressionistic embroideries. Color Tile PhotoStitch Embroidery works best when using pictures with good contrast, and a well defined or transparent background.

Linear PhotoStitch Embroidery

Create a PhotoStitch embroidery from a color or monochrome photo, generating a linear pattern of stitches, or a Maze or Spiral effect, using one thread for a single color result. There are six effects available.

Linear PhotoStitch Embroidery works best when using a picture with good contrast on the face, and without areas of deep shadow.

If the background is transparent, parallel scan lines are created.

Continue

Go to the [Choose Picture](#) page.



Choose Picture

Select a picture file on your computer

Paste a copied picture or import a photo from a scanner or camera

Create or edit in Draw & Paint

The picture is previewed



Use the Choose Picture page to select the picture you wish to convert to a PhotoStitch embroidery.

After selecting a picture, the preview box shows the selected picture with its name underneath.

Select File

- Click Select File to open a picture from one of the Samples subfolders, such as: mySewnet/Samples/Cross Stitch/Pics. Alternatively, browse to a folder elsewhere on your computer.

Note: Click Show as Icons  to view thumbnails of the pictures.

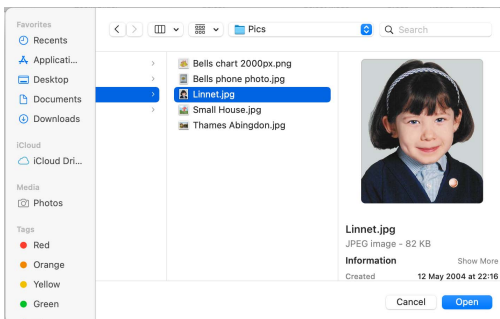

The following popular file formats may be loaded: Bitmap (.bmp), Encapsulated PostScript (.epi, .eps), Graphics Interchange Format (.gif), JPEG-JFIF Compliant (.jpg, .jif, .jpeg), JPEG 2000 (.jp2, .jpf), JPEG Multi-Picture Object (.mpo), Photoshop (.psd), Portable Document Format (.pdf), Portable Network Graphics (.png), Postscript (.ps), Tagged Image File Format uncompressed (.tiff, .tif), Camera RAW

(.raw & many others), High Dynamic Range (.exr, hdr), High Efficiency Image Format (.heic).

These additional formats can also be loaded: Apple Icon (.icns), Fax (.fax & many others), Linux Icon (.xbm), Macintosh Picture (.pct, .pic, .pict), MacPaint (.mac, .pnt, .pntg), Microsoft Icon (.cur, .ico), Silicon Graphics (.rgb, .sgi) and Truevision TGA (.targa, tga).

Select a Photo for a PhotoStitch

- 1 Click Select File. The Open dialog appears.
- 2 Browse to the desired folder, for example mySewnet/Samples/Cross Stitch/Pics.
- 3 Click on a photo.
- 4 Click Open to open the photo onto the Choose Picture page, and to close the dialog. Click the Cancel to exit without selecting a picture.

Other Sources

Paste

- Paste an image from the Clipboard.

Import Image

- Import a picture from a camera or scanner connected to the computer.

Services

Use Services to import a picture.

- **Camera:** Import a picture from an integrated MacBook® camera.
- **Capture Full Screen:** make a screenshot of the whole screen.
- **Capture Selection from Screen:** make a screenshot of part of the screen.

Create New Picture and Edit Picture

Create a new picture or edit an existing picture in mySewnet™ Draw & Paint.

Go Back

Return to the Choose Embroidery Type page.

Continue

Go to the Rotate and Crop Picture page.

Rotate and Crop Picture

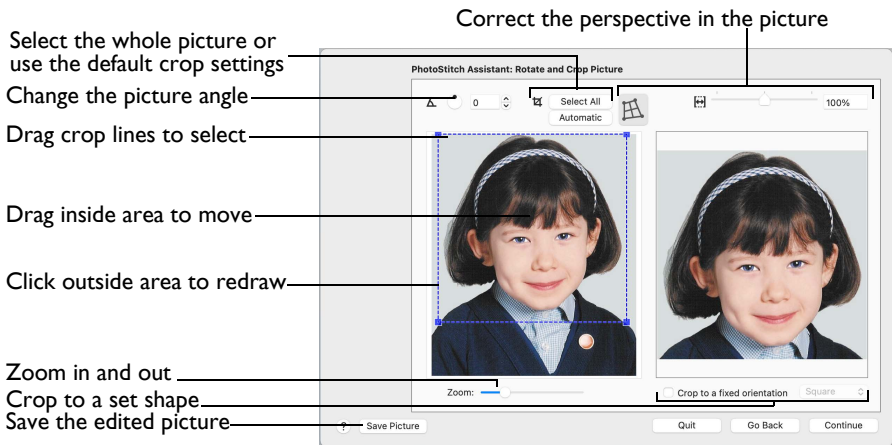

If required, rotate the picture to any angle from 0 to 359 degrees. This can be useful when straightening scanned pictures.

Use Crop to select the section of the picture that is to be used to create the PhotoStitch embroidery. Alternatively, crop to a fixed orientation, selecting from square, portrait and landscape. Use Perspective Correction to adjust for perspective or skew.

Note: To obtain more detail on an individual's face it is often helpful to crop so that only the head and part of the shoulders are shown.

Note: The size of the crop box may vary if the picture is rotated.

Select All: Select the whole of the picture.

Automatic: Select the smallest rectangle that includes all colors that are not the background color.

Rotate and Crop a Picture

- 1 Drag the rotational slider to rotate the picture to the desired angle. Alternatively, enter a number in the rotation angle number box, or use the arrows to increase or decrease the angle of rotation.
- 2 Drag the handles on the crop area boundary line to select the desired part of the picture. Hold the Shift key while dragging to resize the rectangle proportionally. Hold the Option key while dragging to resize the rectangle without moving its center. Alternatively, crop to a fixed orientation, selecting from square, portrait and landscape.
- 3 Drag anywhere inside the crop box to move the crop box.
Note: If you need to expand a crop box again, make sure it is not touching the edge of the frame, as this will stop it expanding.
- 4 If desired, click Automatic to select the crop lines automatically, or click Select All to use the whole of the picture.

Perspective Correction

To remove the effects of perspective in a picture, or to correct skew, select Perspective Correction . When using Perspective Correction, the crop handles are red.

Drag the red handles so that the crop lines frame the picture. Use the Zoom tools to view the outline of the picture more clearly. Drag the Stretch Picture  slider to make the picture in the Preview wider or narrower. Use Save Picture to save your edited picture.

Zoom

Use the Zoom bar to change the view of the picture. Zoom in (drag the slider to the right) to magnify the view. Zoom out (drag the slider to the left) to shrink the view.

When zoomed in, use the scroll bars or swipe to move around.

Go Back

Return to the Choose Picture page.

Continue

Go to the Remove Background page.

Remove Background

Remove areas of background automatically by color

Erase areas of the image

Reverse the last action

Reverse all changes

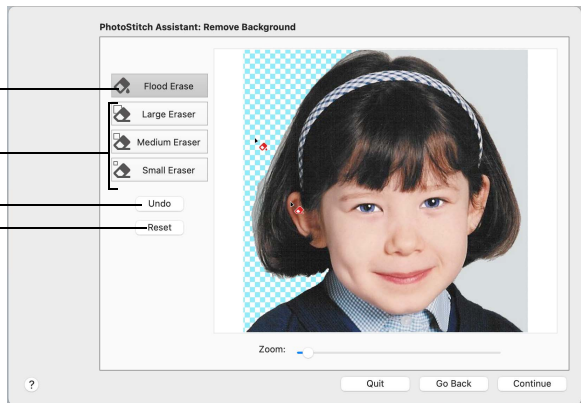

Use the Remove Background page of the PhotoStitch Assistant to remove the background from the photo, so as to emphasize the person's face, or other subject.

Note: Best results may be obtained if the background is completely removed, leaving only the face itself. Removing heavily contrasting colors in the background brings out the subtle color variations in the person's features.

Flood Erase

Select Flood Erase  to remove sections of similarly colored background automatically.

Flood Erase looks for areas with a similar color shade, and replaces them with a transparent background.

- Click Flood Erase , then click on the areas of the picture that you want to remove.

Note: Use Flood Erase in conjunction with Undo on varied backgrounds such as a cloudy sky. A small change in the position of the click may remove desired parts of the picture along with the background.

Flood Erase works best on relatively evenly colored areas. Areas with gradations of colors can be removed in several pieces, but patterned areas may be easier to remove with the Large Eraser.

Note: Some backgrounds may be a similar color to the hair or skin of the person in the foreground. Draw a line around the person with the Small Eraser, then remove the background with Flood Erase.

Note: When Flood Erase is used to remove a very brightly colored background, for example a bright blue sky, there may be a colored edge around the subject of the

picture. This can affect the final embroidery. Use the Small Eraser to carefully remove the colored edge.

Eraser

The Eraser removes any part of the image that it is used on, leaving a transparent background. Three sizes are available.

Note: Lift the mouse button or graphics tablet pen frequently when using one of the erasers. Then if you make a mistake, and need to Undo, you will not lose much work.

Large Eraser

Use the Large Eraser  to remove large areas of background, and to clean remaining fragments of background from a picture.

Note: Patterned backgrounds often contain pixels of widely varying colors, and a few of these may remain when the area has been cleaned with Flood Erase. Remove these with the Large Eraser.

Medium Eraser

Use the Medium Eraser  to clean relatively detailed areas.

Small Eraser

Use the Small Eraser  to remove fine details, or to draw a line to separate a desired area from an unwanted one.

Defining Areas with the Small Eraser

Open your chosen picture in the Remove Background page of the PhotoStitch Assistant, and start removing the background with Flood Erase.



If a desired area of the picture is removed, click Undo.

Select the Small Eraser .



Draw a line to separate the background area from the picture.

You may need to do this in more than one place.



Select Flood Erase again. Continue removing the background area with Flood Erase.

Use Undo if required parts of the picture are removed.

Repeat this process where other parts of the picture are the same color as the adjoining background.

Undo

Use Undo to reverse the last action.

Reset

Use Reset to reverse all changes made to the picture on the current assistant page. Changes made on previous pages are retained.

Zoom

Use the Zoom bar to change the view of the picture. Zoom in (drag the slider to the right) to magnify the view. Zoom out (drag the slider to the left) to shrink the view.

When zoomed in, use the scroll bars or swipe to move around.





Go Back

Return to the Rotate and Crop Picture page.

Continue

Go to the Design Size page.

Remove the Background from a Photo

- 1 In the Create window  of the Control Panel  click PhotoStitch Assistant  > PhotoStitch into Hoop.
- 2 The PhotoStitch Assistant opens at the Choose Embroidery Type page.
- 3 Ensure Color PhotoStitch Embroidery is selected, then click Continue. The Choose Picture page appears.
- 4 Click Select File, and browse to a photo. Click Open.
The picture is loaded onto the Choose Picture page, with the name shown below the preview area.
- 5 Click Continue and the Rotate and Crop Picture page appears.
- 6 No rotation or cropping are required, so click Continue and the Remove Background page appears.
Note: It is recommended to use a graphics tablet and pen, if available, for the Remove Background functions.
- 7 Click Flood Erase .
- 8 Click an area to the side of the picture. Flood Erase removes an area of the background, leaving small differently colored areas behind.
Flood Erase removes a particular color, and very similar colors.
- 9 Continue using Flood Erase to roughly remove similarly colored areas. If need be, use Reset to start again.
Note: Undo reverses the last action, while Reset goes back to the original version of the picture.
- 10 Click a background area similar to the skin color. Part of the face may be removed, along with the background. Click Undo.
If this does not happen the first time, try again nearby.

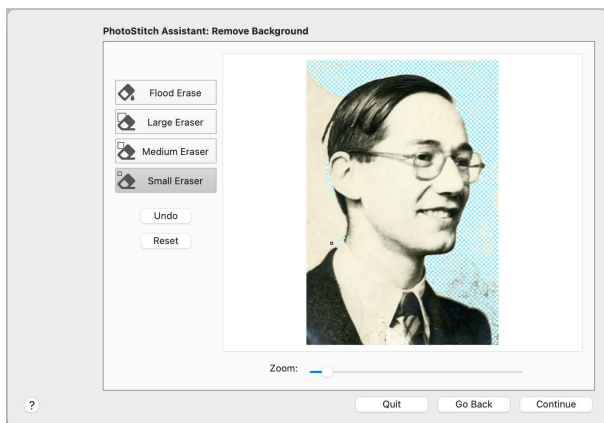

- 11 Use the Zoom bar to magnify the area where the skin and background are a similar color.
- 12 Select the Small Eraser  and draw a line around this area, separating the skin from the background color.



Lift the mouse button or graphics tablet pen frequently. Then if you make a mistake, and need to Undo, you will not lose much work.

- 13 Zoom out to see the full picture again.

- 14 Roughly remove the rest of the background with Flood Erase .

- 15 Click the Large Eraser , and clean the remaining specks from the background. The Medium Eraser  is better for cleaning areas close to Jonathan's head.

Use the Zoom bar to zoom in and out while tidying up the outline.

Note: For a color PhotoStitch, a slightly rough outline will not affect the final embroidery, but specks of background may lead to 'stray stitches'.

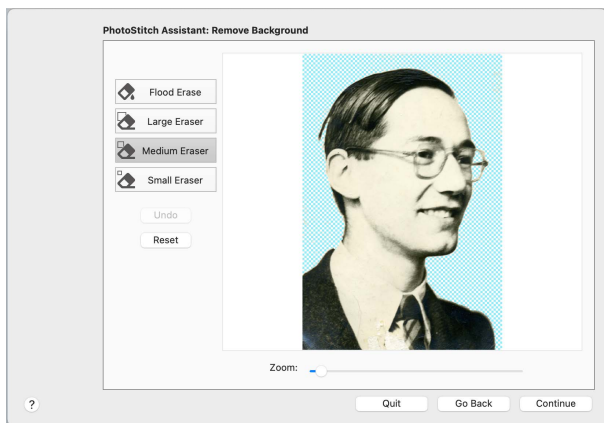

- 16 Click Continue. The Design Size page appears.
- 17 Click through the rest of the PhotoStitch Assistant until the PhotoStitch Embroidery Options page appears.
- 18 If you can see specks in the background of the embroidery, click Go Back to return to the Remove Background page and zoom in to examine the picture closely. Use one of the erasers to remove any remaining flecks. Then click Continue until the PhotoStitch Embroidery Options page appears.
- 19 Click Done to finish, and place the embroidery in the work area.



Picture Options

Improve brightness & contrast _____

Remove red eye effect _____

Return to the original picture _____

Adjust grays and flesh tones _____

Save the edited picture _____

Zoom in on the picture _____

Use the Picture Options page to remove Red Eye from your picture, and to adjust saturation and contrast in the picture.

Autolevel

Use Autolevel to improve the brightness and contrast in most photos. It can also be used to bring out the color in underexposed pictures.

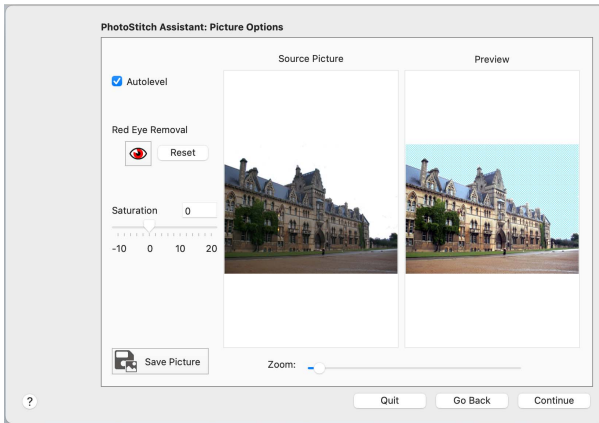

By default Autolevel is enabled.

Note: Occasionally Autolevel does not improve the appearance of a picture, and may need to be switched off.

Red Eye Removal

Use Red Eye Removal  to reverse the red eye effect caused when flash is reflected back by the retina of the eye.

Note: Red Eye Removal can also be used to remove other intrusive reds, such as red lights.

Select Eye

Use Select Eye  to select Red Eye removal.

Remove Red Eye Effect from a Picture

- 1 Click Select Eye .
- 2 Zoom in to magnify the affected area.
- 3 Draw an ellipse around the affected eye in the Source Picture panel. Any bright red in that part of the picture has a blue cast added to it, to counteract the red effect. If you make a mistake, use Reset to reverse red eye removal, then try again.
- 4 Check the result in the Preview panel.
- 5 Remove any other examples of red eye in the picture.

Reset

Use Reset to reverse the effects of red eye removal.

Saturation

Adjust saturation to change the amount of gray in your picture. To make the image colors warmer, move the slider to the right. Move to the left to make the image more gray.

Note: Saturation is best used on Color PhotoStitch and Color Tile PhotoStitch embroideries.

Move the Saturation slider bar to the desired setting, or enter a value directly in the box. The initial value for Saturation is 0.

Save Picture

Use Save Picture to save changes to a picture that you edited. The Save Picture dialog appears.

The following file formats may be saved: Windows or OS2 Bitmap (.bmp), JPEG Low Quality (.jpg), JPEG High Quality (.jpg), Tagged Image File Format uncompressed (.tif) and Portable Network Graphics (.png).

Note: Portable Network Graphics (.png) is recommended as it is relatively compact, yet preserves the colors of the photo.

Preview

The panel on the left shows the original picture, and the preview picture on the right shows the result of applying Autolevel, Red Eye Removal, and adjusting saturation.

Back

Return to the Remove Background page.

Continue

Go to the Design Size page.

Design Size

Set the size of the design

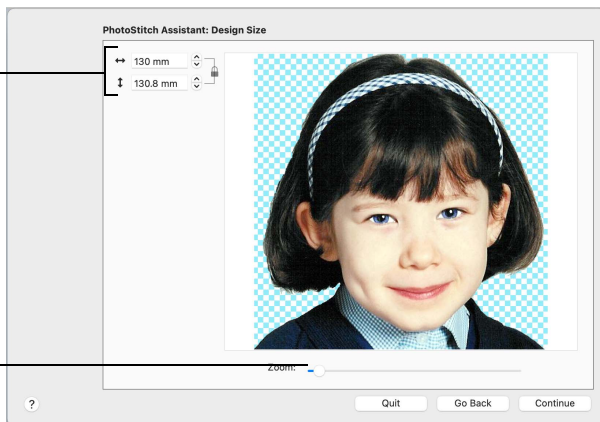

Zoom in and out on the design

Use the Design Size page to set the size for your PhotoStitch.

The lock indicator shows that the original proportions of the rectangle or hoop cannot be changed.

Set the Design Size

- Click the Size up and down arrows or enter a number to change the design size.

Zoom

Use the Zoom bar to change the view of the picture. Zoom in (drag the slider to the right) to magnify the view. Zoom out (drag the slider to the left) to shrink the view.

When zoomed in, use the scroll bars or swipe to move around.

Go Back

Return to the Remove Background page.

Continue

The available options depend on your choice in the Choose Embroidery Type page.

- For Color PhotoStitch Embroidery, Sepia PhotoStitch Embroidery, Monochrome PhotoStitch Embroidery, and Color Tile PhotoStitch Embroidery, go to the Choose Thread Colors page.
- For Linear PhotoStitch Embroidery, go to the Linear Embroidery Options page.

Choose Thread Colors

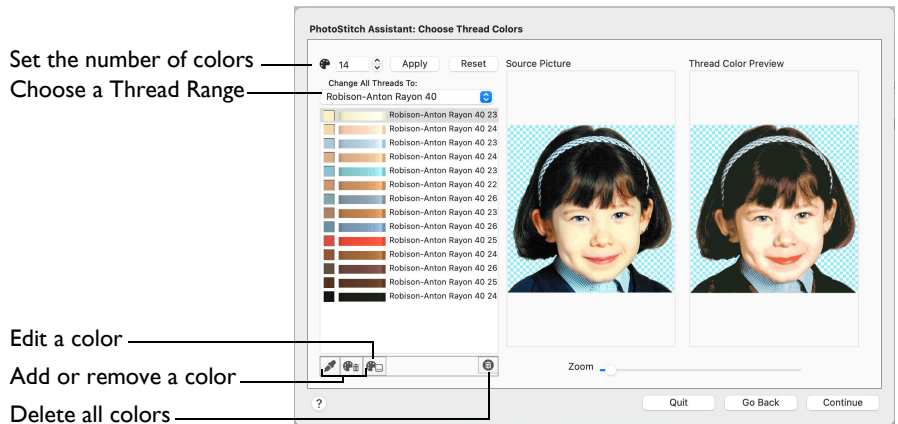

Use the Choose Thread Colors page to match thread colors to colors in the photo. The Choose Thread Colors page appears when you are creating a color, sepia, monochrome or color tile PhotoStitch embroidery.

Color Selection

Number of Colors : Set the number of thread colors used in the embroidery. The number of colors is initially set to the recommended number for the picture.

Note: An initial palette of 7 colors is provided for a sepia PhotoStitch, and 11 colors for a monochrome PhotoStitch.

- Click the Number of Colors up and down arrows or enter a number to change the number of colors.

Apply: Update the list of threads and the thread color preview.

Reset: Return the thread list to the initial (recommended) set of threads. The palette is reset to 7 colors for a sepia PhotoStitch, or 11 colors for a monochrome PhotoStitch.

Note: When Reset is used, any custom thread matches that were made must be re-selected with Edit Selected Color.

Change All Threads To

Change the thread range. When a thread range is chosen, each color in the picture is assigned the nearest matching thread color from the chosen thread range.

- Choose a thread range from the pop-up menu.

Note: When a new thread range is chosen, all custom thread matches set by Edit Selected Color are lost.

Picture and Thread Color List

The list shows a thread color for each color currently selected from the picture.

The same thread color may be matched to two or more colors in the picture. Each thread color can be individually changed with Edit Selected Color. When thread colors are changed in the list, the Thread Color Preview is updated.

Note: When more than one color in the picture is matched to the same thread color, the number of color changes in the final embroidery is reduced.



Change Colors

Pick New Colors

Use Pick New Colors  to add thread colors to the list by selecting them from the source picture.

Note: The thread color is picked for the clicked color according to the RGB (red, green, blue) value at the point clicked. If there is already a thread color assigned to that exact RGB value, it is highlighted in the list instead of adding a thread color to the list.

Pick a New Thread Color

- 1 Click Pick New Colors .
- 2 Move the pointer over the Source Picture. The pointer changes to an eye-dropper .
- 3 Click the picture to pick up the color under the tip of the eye-dropper.
The nearest matching thread color from the selected Thread Range is automatically selected and added to the thread color list. Because the PhotoStitch effects use a color blending process, the colors are recalculated.

Delete Selected Color

Use Delete Selected Color  to remove the highlighted color from the list.

Because the PhotoStitch effects use a color blending process, the colors are recalculated. The Thread Color Preview is displayed again, with the reduced set of thread colors.

Edit Selected Color

Use Edit Selected Color  to change a thread color.

Note: It is recommended only to use Edit Selected Color after the main thread range has been selected.

- Click a color in the list, then click Edit Selected Color. The Color Selection dialog appears so that a different thread color can be chosen. See “Color Selection Dialog” on page 79.

Delete All Colors

Use Delete All Colors  to remove all the thread colors from the list.

Note: Delete All Colors can be used to clear all colors before using Pick New Colors to choose colors from the Source Picture.

Previews

Source Picture: This shows the original picture, after being rotated and cropped, in full color.

Thread Color Preview: This shows how the thread colors have been chosen to replace colors in the picture. This gives an approximate indication of where thread blocks will be in the final design.

Note: If variegated threads have been selected, only the first color is shown in the preview.

Zoom

Use the Zoom bar to change the view of the picture. Zoom in (drag the slider to the right) to magnify the view. Zoom out (drag the slider to the left) to shrink the view.

When zoomed in, use the scroll bars or swipe to move around.

Go Back

Return to the Design Size page.

Continue

The available options depend on your choice in the Choose Embroidery Type page.

- For Color PhotoStitch Embroidery, Sepia PhotoStitch Embroidery, and Monochrome PhotoStitch Embroidery, go to the PhotoStitch Embroidery Options page.
- For Color Tile Embroidery, go to the Color Tile Options page.

PhotoStitch Embroidery Options

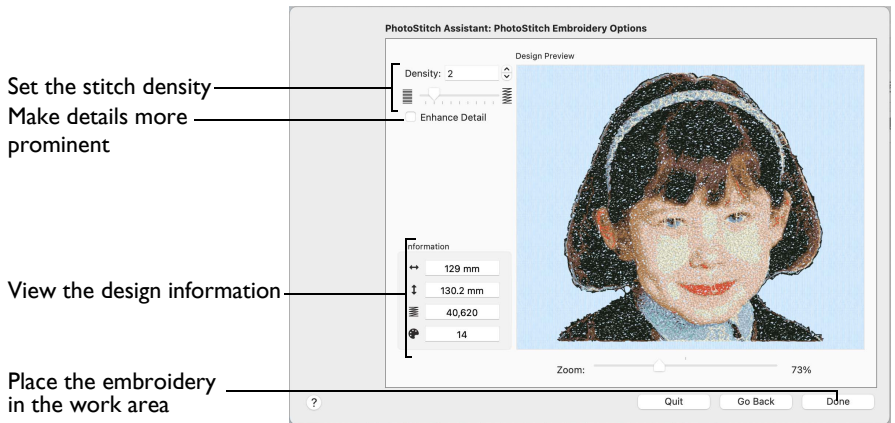

Use the PhotoStitch Embroidery Options page to change the stitch density and enhance detail in the picture. View and check the final design in 3D before closing the PhotoStitch Assistant.

Stitch Options

Use Density to change the number of stitches, or Enhance Detail to bring out the detail in the picture.

Enhance Detail: This makes details in the picture more prominent. For example, it can be used to improve definition in a photo with good detail, but little contrast.

Note: Enhance Detail does not change the colors used, it affects the way that those colors are used.

Density: Select the density of the stitching. 1 is the standard default density, 9 is the most open.

Zoom

Use the Zoom bar to change the view of the picture. Zoom in (drag the slider to the right) to magnify the view. Zoom out (drag the slider to the left) to shrink the view.

When zoomed in, use the scroll bars or swipe to move around.

Design Information

The design information boxes show the number of stitches in the embroidery, the height and width and the total number of color changes.

Go Back

If desired, use the Go Back button to go back through the PhotoStitch Assistant and modify settings before previewing the design again.

Done

Accept the final design and close the PhotoStitch Assistant.

Color Tile Options

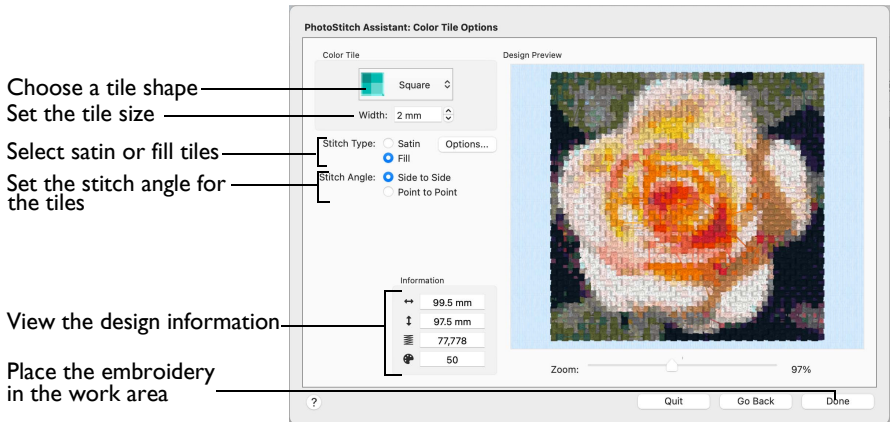

Use the Color Tile Options page to choose tile shape for the embroidery, select the stitch type, and the tile size and angle. View and check the final design in 3D before closing the PhotoStitch Assistant.

The Color Tile Options page of the PhotoStitch Assistant only appears when you create a Color Tile embroidery.

Color Tile

The available tile shapes are:

- Diamond
- Square
- Hexagon

The default tile shape is Diamond.

The tile size is based on the width of the tile at its widest point.

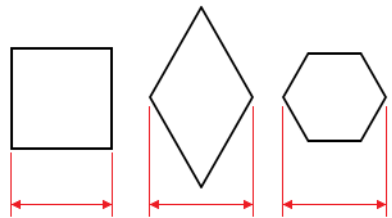

- Choose a tile shape from the pop-up menu.

Width

Select the width (size) of the tiles.

- Click the arrows to set Width from 2 to 5mm, or enter a value in the number box.

Stitch Type

The stitch options selected here are retained until changed.

Satin

Use Satin stitch for the tiles.

- Select Satin, then click the Options button to set the Density options.

Satin Density

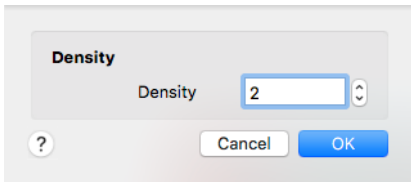

Set the stitch Density for the Satin stitch tiles. The lower the number, the closer together the stitches and the more stitches are produced.

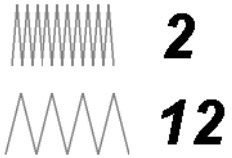

- Click the arrows to set Density from 2 to 12, or enter a value in the number box.

Fill

Use Fill for the tiles.

- Select Fill, then click the Options button to set the Density options.

Fill Density

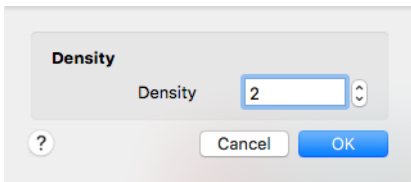

Set the stitch Density for the Fill tiles. The lower the number, the closer together the stitches and the more stitches are produced.

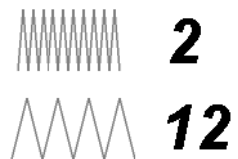

- Click the arrows to set Density from 2 to 12, or enter a value in the number box.

Stitch Angle

Set the stitch angle for the tiles. **Side to Side** uses stitches that are parallel to the sides of the shape, and **Point to Point** uses stitches that run from corner to corner of the shape.

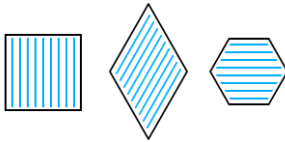

Side to Side

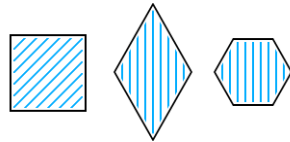

Point to Point

- Select the **Stitch Angle** for the tiles.

Zoom

Use the **Zoom** bar to change the view of the picture. **Zoom in** (drag the slider to the right) to magnify the view. **Zoom out** (drag the slider to the left) to shrink the view.

When zoomed in, use the scroll bars or swipe to move around.

Design Information

The design information boxes show the number of stitches in the embroidery, the height and width and the total number of color changes.

Go Back

If desired, use the **Go Back** button to go back through the **PhotoStitch Assistant** and modify settings before previewing the design again.

Done

Accept the final design and close the **PhotoStitch Assistant**.

Linear Embroidery Options

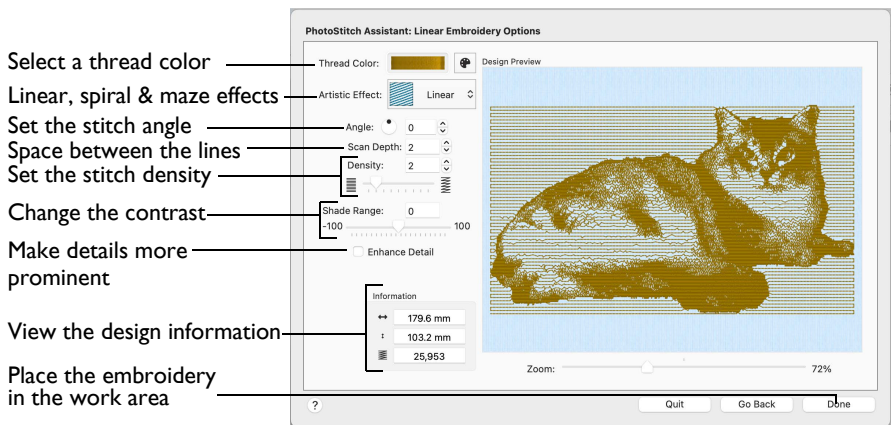

Use the Linear Embroidery Options page to choose the color for the embroidery. Optionally, use a Linear, Spiral or one of four Maze stitch effects, change the angle of the stitching, select scan depth and density, and enhance detail in the picture. View and check the final design in 3D before closing the PhotoStitch Assistant.

The Linear Embroidery Options page of the PhotoStitch Assistant only appears when you are creating a Linear PhotoStitch embroidery.

Thread Color

Use Thread Color to select the color used for stitching the linear PhotoStitch embroidery.

- Click Thread Color . The Color Selection dialog opens. See “Color Select” on page 78.

Artistic Effect

Use an artistic effect. The available options are Linear, Spiral and four Maze effects.

- Choose an artistic effect from the pop-up menu.





Monochrome Linear

Choose Monochrome Linear  to use straight lines of thread for the basic stitch pattern. The lines are smooth for light areas of the picture. Zigzag stitches on either side of the lines emphasize the detail of the picture.

Monochrome Spiral

Choose Monochrome Spiral  to use circular lines of thread for the basic stitch pattern. The lines are smooth for light areas of the picture. Zigzag stitches on either side of the lines emphasize the detail of the picture.

Monochrome Maze

Choose the Monochrome Maze (, ,  and ) modes to use one of four patterns to build up the picture. The stitching is sparse for light areas of the picture, which also reveals the basic shape used by the Maze mode you have chosen. Increased density of stitching emphasizes the detail of the picture.

Angle

Use Angle to change the angle at which the stitches are created for the embroidery. Changes in Angle are visible in the preview.

- Enter an Angle from 0 to 360 degrees. The initial setting is 0.

Note: Alter the Angle by typing a number in the box, or use the up and down arrows to change the number. The computer will recalculate how to stitch the picture.

Enhance Detail

Use Enhance Detail to make details in the picture more prominent. For example, it can be used to improve definition in a picture with good detail, but little contrast.

By default, Enhance Detail is deselected.

Scan Depth

Scan Depth refers to the distance between the lines that produce an embroidery from a picture. The lower the Scan Depth figure, the finer the detail shown in the embroidery, and the more stitches produced.

Changes in Scan Depth are visible in the preview.

- Set Scan Depth from 1 to 20. The default and recommended setting is 2.

Density

The density of the stitching along each line. The lower the Density number, the closer together the stitches, and the more stitches are produced.

Changes in Density are visible in the preview.

Note: Depending on the fabric and machine used, a lower number may produce more detail in the embroidery.

- Set Density from 1 to 9. The recommended (and default) setting is 2.

Shade Range

Change the contrast in the picture. Negative values make the picture darker, and positive values make the picture lighter.

Zoom

Use the Zoom bar to change the view of the picture. Zoom in (drag the slider to the right) to magnify the view. Zoom out (drag the slider to the left) to shrink the view.

When zoomed in, use the scroll bars or swipe to move around.

Design Information

The design information boxes show the number of stitches in the embroidery, the height and width and the total number of color changes.

Go Back

Return to the Design Size page.

Done

Accept the final design and close the PhotoStitch Assistant.

Use the Family Tree Assistant to create an embroidered family chart of up to three generations of ancestors or descendants for an individual.

Use the Family Tree Assistant  to enter the names and relationships of other family members, and select lettering, a frame and connectors to use for the family chart.

On the work area use Save to save the family tree

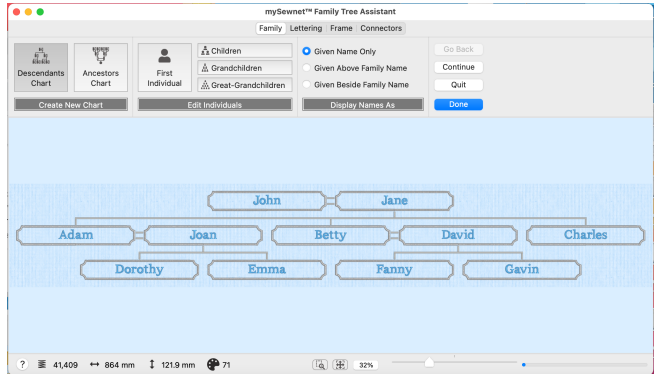

embroidery as a grouped .vp4 file for later use.







Note: The most recently created family tree is stored by the assistant. It is reopened the next time the assistant is used.

Family Tree Assistant

Use the Family Tree Assistant to create a family tree for an individual. Enter the family members for a Descendants Chart or for an Ancestors Chart, and choose how the names will be presented. Select a font style, thread color, shape and size. Surround the names with a frame or flourish. Choose Connectors to link the partners in the chart.

- In the Create window  of the Control Panel  click Family Tree Assistant .
- Choose Assistants > Family Tree Assistant.

Overview





- 1 In the Create window  of the Control Panel  click Family Tree Assistant . Alternatively, choose Assistants > Family Tree Assistant. The Family page opens.
- 2 In the Family page, select to start a Descendants Chart , or an Ancestors Chart . A Descendants Chart shows the partner, children, grandchildren and great-grandchildren of the selected individual. This example uses a Descendants Chart. An Ancestors Chart shows the father and mother, grandparents, and great-grandparents of the selected individual.
- 3 If you have previously created a family tree chart, you are asked if you want to remove the family data that you entered then. Click OK to continue. The First Individual dialog opens.

Note: To open an existing family tree, click the First Individual button.

- 4 In the First Individual dialog, enter the Given Name and Family Name of the person the tree is for, and indicate if they are Male or Female.
- 5 Click Continue to enter further individuals in the family tree.

<p>Enter the details for the First Individual in the family tree.</p>	<p>Add the details for the children of the First Individual.</p>	<p>Add the details for grandchildren of the First Individual.</p>

Note: The family chart embroidery appears as you enter the data.

- 6 Enter the names and gender of the partner and children of the first individual, adding the oldest first.
- 7 Click Continue to add grandchildren (the children of the oldest child).
 Note: Click Continue again to add grandchildren for each of the other children, and then to add great-grandchildren for each of the grandchildren.
- 8 When you have finished entering information for the family tree, click Done to view the tree in the Family page of the assistant.
 Note: Use the First Individual , Children , Grandchildren , and Great-Grandchildren  buttons to change the details for the individuals that you entered. The dialog opens at the oldest; click Continue to view the other siblings.
- 9 Use the Display Names As options to show only the Given Names, or to also view the Family Names.
- 10 Click Continue to change the lettering used in the family tree. Alternatively, click the Lettering tab.
- 11 In the Lettering page select the style for the text in the family tree. Choose the font, size, color, spacing and stitch type options for the names.

Set the font size and layout Set the connection type Change the thread color

Choose a font Set the stitch type options Adjust other settings or finish

- 12 Click Continue to change the frames used in the family tree.

- 13** In the Frame page choose whether to use frames, and select a frame, corners, side pieces or a flourish for each individual. Change the color and stitch options for the frame.

Use a Frame, Corners or Side Pieces

Change the appearance of the stitching in the frame

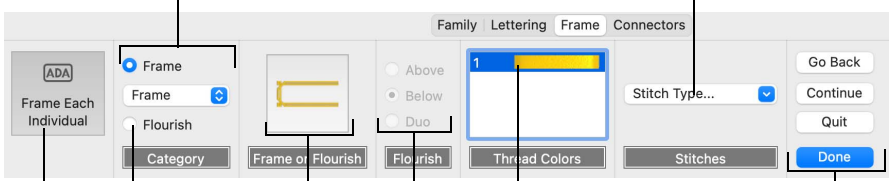

Use flourishes

Select a frame

Change the thread color for the frame

Place a frame around each name

Choose the flourish position

Adjust other settings or finish

- 14** Click Continue to change the connectors used between partners in the family tree.

- 15** In the Connectors page select satin line or a running stitch line for connectors, or use no connectors.

Choose a line type for connectors

Change the thread color

Adjust other settings or finish

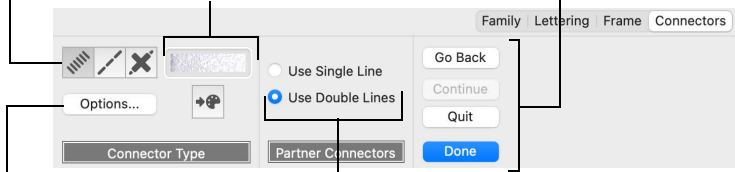

Change the settings for the connectors

Use double stitch lines to indicate a partnership

- 16** Choose a single or double line connector for partners. Change the thread color used for connectors.

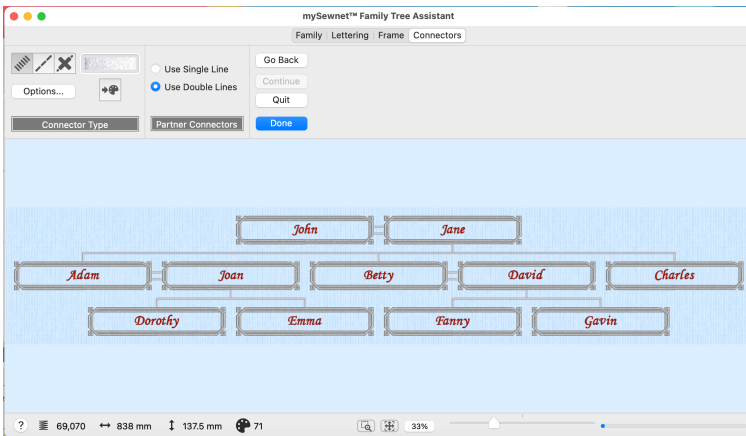

- 17** Check your work by clicking the tabs or by using Continue and Go Back to view the Family Tree Assistant pages. Adjust your settings as desired.



- 18** Click Done to place the family tree chart in the work area as a grouped .vp4 file with fixed lettering and frames.

Family

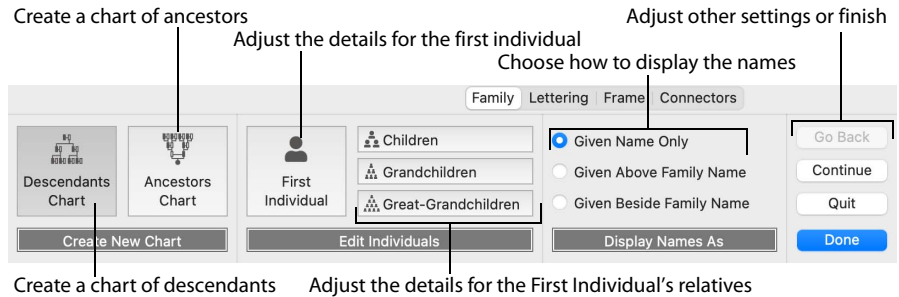
In the Family page, choose a Descendants or Ancestors Chart, and then add and adjust the details for a First Individual, and for other family members. Choose whether just Given Names, or Given and Family names will be displayed, and how they will be placed.



Create New Chart

Choose from Descendants Chart  and Ancestors Chart .

- A Descendants Chart shows the partner, children, grandchildren and great-grandchildren of the selected individual.
- An Ancestors Chart shows the father and mother, grandparents, and great-grandparents of the selected individual.

- Click to select the desired option. The First Individual dialog opens. See “First Individual” on page 319.

Edit Individuals

After creating a family tree, use the Edit Individuals options to change the details for family members. The options for the Descendants Chart and the Ancestors Chart are different.

First Individual  opens the First Individual dialog (the box for the key person in the family tree). See “First Individual” on page 319.

Descendants Chart

Children  opens the Children dialog (the box for the partner of the first individual, and any of their children). See “Children” on page 319.

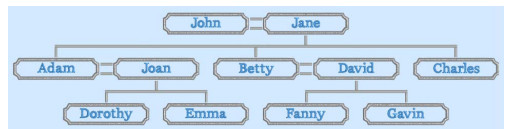

Grandchildren  opens the Grandchildren dialog for the first entered child (the box for the partner of the first child, and any of their children). See “Grandchildren” on page 320.

Note: Click Continue to view the Grandchildren dialogs for the other children.

Great-Grandchildren  opens the Great-Grandchildren dialog for the first entered grandchild (the box for the partner of the first grandchild, and any of their children). See “Great-Grandchildren” on page 320.

Note: Click Continue to view the Great-Grandchildren dialogs for the other grandchildren.

Ancestors Chart

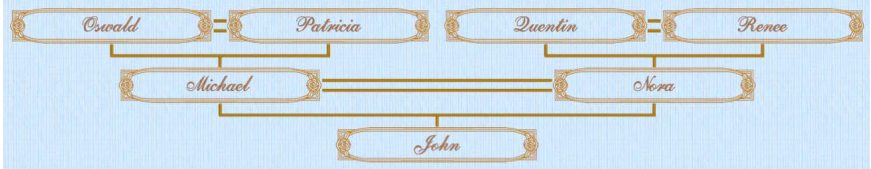

Parents  opens the Parents dialog for the first individual. See “Parents” on page 321.

Grandparents  opens the Grandparents dialog for the father’s father for the first individual, and their partner. See “Grandparents” on page 321.

Note: Click Continue to view the Grandparents dialogs for the other parents.

Great-Grandparents  opens the Great-Grandparents dialog for the great-grandfather on the father’s side. See “Great-Grandparents” on page 322.

Note: Click Continue to view the Great-Grandparents dialogs for the other grandparents.

Display Names As

Select how to display the names of the individuals in the family tree.

- Given Name Only shows only the first name for the family members.
- Given Above Family Name shows the first name above the family name.
- Given Beside Family Name shows the first name alongside the family name.



Continue

Go to the Lettering page.

Note: Alternatively, click the Lettering tab.

Done

Accept the final family tree and close the Family Tree Assistant.

Cancel

Close the Family Tree Assistant without creating a family tree.

First Individual

Use the First Individual dialog to enter the names for the First Individual, and indicate their gender.

Given Name

Enter the Given Name (first name) for the First Individual.

Family Name

Enter the Family Name (surname) for the First Individual.

Gender

Select Male or Female for the gender of the First Individual.

First Individual

Enter the name and gender for the First Individual.

Given Name: John

Family Name: Evans

Gender: Male Female

Create a Descendants chart.

Close Go Back Continue

Descendants Chart

Use a Descendants Chart to show the partner, children, grandchildren and great-grandchildren of the first individual.

Children

Use the Children dialog to enter the names of the partner and children of the First Individual. Use Enter Another Partner to add a second partner and their children.

Partner

Enter the Given Name and the Family Name for the First Individual's partner.

Children

Enter the Given Name and Family Name for each of the family's children, and indicate their gender.

Note: Enter the names of the children in order of age, with the oldest first.

Enter Another Partner

Click the Enter Another Partner button to open a second Children dialog. Enter the details for a second family here.

Children

Please enter family names for Jane Evans

Partner

Given Name: Jane

Family Name: Smith

Children

	Given Name	Family Name	
1:	Adam	Evans	<input type="radio"/> M <input type="radio"/> F
2:	Betty	Evans	<input type="radio"/> M <input checked="" type="radio"/> F
3:	Charles	Evans	<input checked="" type="radio"/> M <input type="radio"/> F
4:			<input type="radio"/> M <input checked="" type="radio"/> F
5:			<input type="radio"/> M <input checked="" type="radio"/> F
6:			<input type="radio"/> M <input checked="" type="radio"/> F

Enter Another Partner

Leave the name for any individual blank to not include them in the tree. You may return to add data later.

Close Go Back Continue

Grandchildren

Use the Grandchildren dialog to enter the names of the partner and children of a child of the First Individual. Use Enter Another Partner to add a second partner and their children.

Note: The children of the First Individual are displayed in the order in which they were entered. So, if the oldest was entered first, they will be displayed first. Click Continue to view the details for the other children.

Partner

Enter the Given Name and the Family Name for the child's partner.

Children

Enter the Given Name and Family Name for each of the family's children, and indicate their gender.

Note: Enter the names of the children in order of age, with the oldest first.

Enter Another Partner

Click the Enter Another Partner button to open a second Grandchildren dialog. Enter the details for a second family here.

Grandchildren

Please enter family names for Adam Evans

Partner

Given Name: Joan
Family Name: Green

Children

	Given Name	Family Name		
1:	Dorothy	Evans	<input type="radio"/> M	<input checked="" type="radio"/> F
2:	Emma	Evans	<input type="radio"/> M	<input checked="" type="radio"/> F
3:			<input type="radio"/> M	<input checked="" type="radio"/> F
4:			<input type="radio"/> M	<input checked="" type="radio"/> F
5:			<input type="radio"/> M	<input checked="" type="radio"/> F
6:			<input type="radio"/> M	<input checked="" type="radio"/> F

Enter Another Partner

Leave the name for any individual blank to not include them in the tree. You may return to add data later.

Close Go Back Continue

Great-Grandchildren

Use the Great-Grandchildren dialog to enter the names of the partner and children of a grandchild of the First Individual. Use Enter Another Partner to add a second partner and their children.

Note: The grandchildren of the First Individual are displayed in the order in which they were entered. So, if the oldest was entered first, they will be displayed first. Click Continue to view the details for the other grandchildren.

Partner

Enter the Given Name and the Family Name for the grandchild's partner.

Children

Enter the Given Name and Family Name for each of the family's children, and indicate their gender.

Note: Enter the names of the children in order of age, with the oldest first.

Great-Grandchildren

Please enter family names for Dorothy Evans

Partner

Given Name: Howard
Family Name: Jones

Children

	Given Name	Family Name		
1:	Ivan	Jones	<input checked="" type="radio"/> M	<input type="radio"/> F
2:	Joseph	Jones	<input checked="" type="radio"/> M	<input type="radio"/> F
3:	Kathy	Jones	<input type="radio"/> M	<input checked="" type="radio"/> F
4:			<input type="radio"/> M	<input checked="" type="radio"/> F
5:			<input type="radio"/> M	<input checked="" type="radio"/> F
6:			<input type="radio"/> M	<input checked="" type="radio"/> F

Enter Another Partner

Leave the name for any individual blank to not include them in the tree. You may return to add data later.

Close Go Back Continue

Enter Another Partner

Click the Enter Another Partner button to open a second Great-Grandchildren dialog. Enter the details for a second family here.

Ancestors Chart

Use an Ancestors Chart to show the father and mother, grandparents, and great-grandparents of the first individual.

Parents

Use the Parents dialog to enter the names of the parents of the First Individual.

Father

Enter the Given Name and the Family Name for the First Individual's father.

Mother

Enter the Given Name and the Family Name for the First Individual's mother.

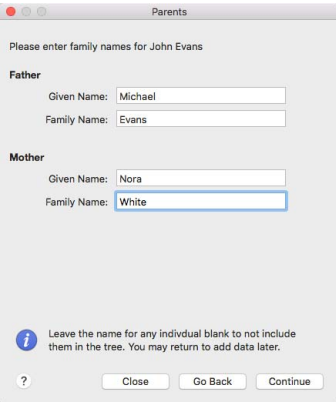

The screenshot shows a dialog box titled "Parents" with the subtitle "Please enter family names for John Evans". It contains two sections: "Father" and "Mother". Under "Father", the "Given Name" field is filled with "Michael" and the "Family Name" field is filled with "Evans". Under "Mother", the "Given Name" field is filled with "Nora" and the "Family Name" field is filled with "White". At the bottom, there is an information icon with the text "Leave the name for any individual blank to not include them in the tree. You may return to add data later." and three buttons: "?", "Close", "Go Back", and "Continue".

Grandparents

Use the Grandparents dialog to enter the names of the grandparents of the First Individual.

Note: The father's parents are displayed first. Click Continue to view the mother's parents.

Father

Enter the Given Name and the Family Name for the First Individual's grandfather.

Mother

Enter the Given Name and the Family Name for the First Individual's grandmother.

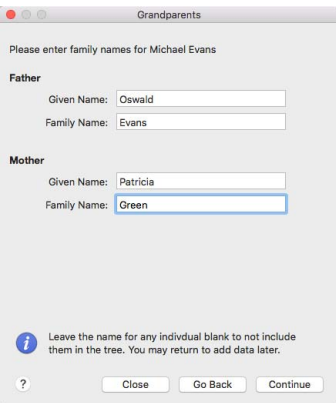

The screenshot shows a dialog box titled "Grandparents" with the subtitle "Please enter family names for Michael Evans". It contains two sections: "Father" and "Mother". Under "Father", the "Given Name" field is filled with "Oswald" and the "Family Name" field is filled with "Evans". Under "Mother", the "Given Name" field is filled with "Patricia" and the "Family Name" field is filled with "Green". At the bottom, there is an information icon with the text "Leave the name for any individual blank to not include them in the tree. You may return to add data later." and three buttons: "?", "Close", "Go Back", and "Continue".

Great-Grandparents

Use the Great-Grandparents dialog to enter the names of the great-grandparents of the First Individual.

Note: The father's father's parents are displayed first. Click Continue to view the other grandparents in the order father, mother, father, mother.

Father

Enter the Given Name and the Family Name for the First Individual's great-grandfather.

Mother

Enter the Given Name and the Family Name for the First Individual's great-grandmother.

Great-Grandparents

Please enter family names for Oswald Evans

Father

Given Name: Simon

Family Name: Evans

Mother

Given Name: Tina

Family Name: Baker

Leave the name for any individual blank to not include them in the tree. You may return to add data later.

? Close Go Back Continue

Lettering

Use the Lettering page to select the style for the text in the family tree. Choose the font, size, color, spacing and stitch type options for the names.

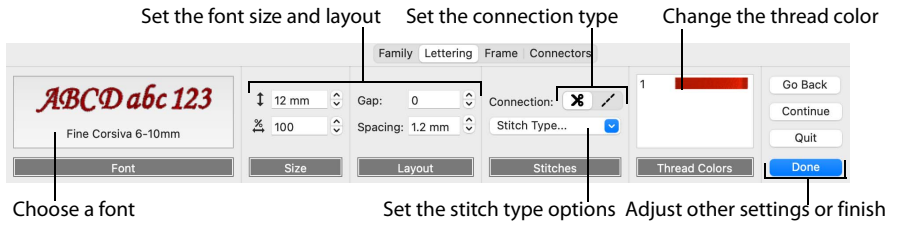

Lettering is created from the fonts available in the mySewnet™ Embroidery Software. Set lettering styles in the Lettering page of the Family Tree Assistant. Font means lettering style. The current font is shown in the Lettering page.

As the lettering is changed, the preview below reflects the changes made.

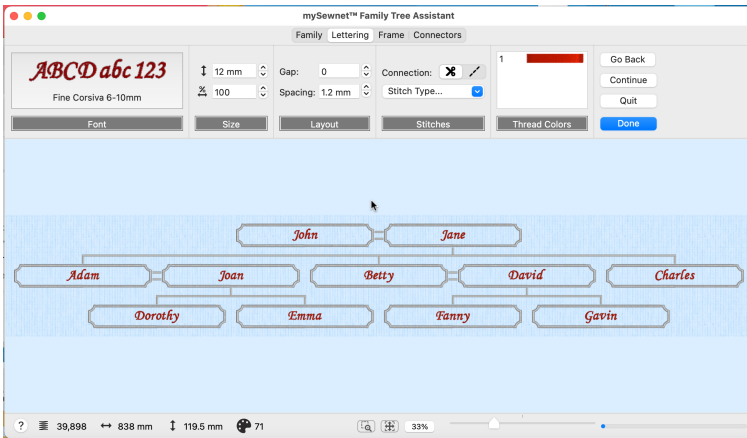

Change the Appearance of Lettering

Follow these steps to change the appearance of the lettering in a family tree:

Note: For more on lettering, see “Creating Lettering” on page 355.

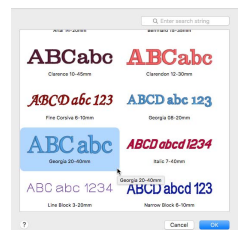

Select a Font

Click the font display, and the font dialog appears.





- 2 Scroll up or down to select a font from one of the 18 themed font categories.
Note: The font name specifies the recommended size range for each font. For example, Rian 10-30mm has a recommended size range of 10mm to 30mm. Font names with UC are uppercase only fonts (that is, they have no lowercase characters), and with LC are lowercase only. For more information on fonts, see “About Fonts” on page 359.

Set the Size and Layout

- 3 Set the font Size  in millimeters or inches as desired, from 3mm to 200mm.
Note: This sets the height of the 'A' character in the font. All other characters and symbols are sized relative to the height of 'A'. The size is initially set to the minimum recommended size for the chosen font. Fonts appear best when using the recommended size range. See “Font Size” on page 362.
- 4 If desired, change the proportions of the lettering in the percentage Width  box. Change the width from one quarter to four times the default setting. See “Height and Width” on page 362.
- 5 If desired, change the Gap from -99 to 99. Negative values move characters closer together, and positive values move them farther apart. See “Gap and Kerning” on page 362.
Note: Lowercase characters in Script fonts are not affected by the Gap setting.
- 6 To change the distance between multiple lines of text, adjust Spacing from 1.0 to 5.0.
Note: Spacing is relative to the height of the 'A' character. The default spacing is 1.2.

Choose a Connection Method

- 7 To choose the connection method, click Trim  (joined by movement stitches that are automatically trimmed by compatible machines) or Running Stitch , as desired. See “Connection” on page 363.
Note: Trim is recommended for most fonts. Running Stitch is recommended for very small text using Nearest Point fonts.

Change Letter Properties and Color

- 8 Select a line or fill type from the Stitch Type pop-up menu. The properties dialog for the stitch type appears. See “Choosing Stitch Properties” on page 462.
- 9 Use the properties dialog to change the lettering properties, for example the density, and the stitch length, angle and pattern.
Note: If the Stitch Type area is dimmed (unavailable), this means that the font was designed with properties that cannot be edited. This is usually because the properties are not the same throughout the font. For instance, different letters may use different fill patterns. For example, in the Modern category, Bremen UC 10-25mm has Satin Column stitches, therefore the Satin Column option is available. Bremen UC 15-60mm has Pattern Fill stitches, therefore the Pattern Fill option is available. In the Monogram category, Athletic Square 2C UC 30-80mm has both Satin Column and Pattern Fill stitches, therefore both options are available. In the Floral category Acorn 6C UC 35-60mm uses more than one type of Pattern Fill, therefore no Stitch Type is available.
- 10 Set the Thread Color to use when embroidering the text. Click one of the thread color blocks to open the Color Selection dialog. See “Color Selection Dialog” on page 79. Scroll down to see other font colors.

Go Back

- Click Go Back to go to the Family page. Alternatively, click the Family tab.

Continue

Go to the Frame page.

Done

Accept the final family tree and close the Family Tree Assistant.

Cancel

Close the Family Tree Assistant without creating a family tree.

Frame

Use the Frame page to choose whether to use frames, and to select a frame, corners, side pieces or a flourish for each individual. Change the color and stitch options for the frame.

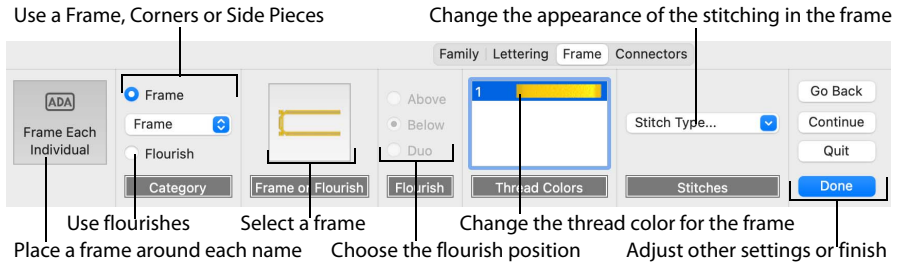

Choose from the categories of corners, frames and side pieces. Then choose a frame set, and select a design. Alternatively, select Flourish and choose a flourish to be placed above, below or as a duo above and below the selected name.

Note: In the text below corners, flourishes, frames and side pieces are referred to collectively as frames.

As the frames are changed, the preview below reflects the changes made.

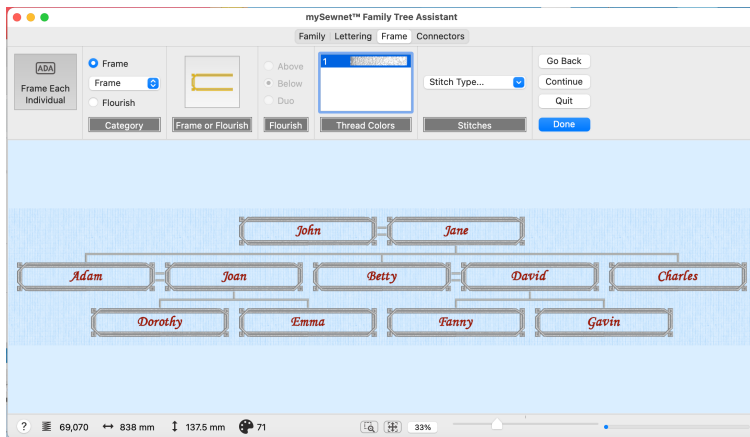

Frame Each Individual

Choose whether to use a frame, corners, side pieces, or a flourish for each individual's name, or to use the name alone.

Note: Frames and flourishes are placed at a size to suit the names.

Category

Frames, corners, flourishes or side pieces are placed around the names. Click Frame and select one of corners, frames or side pieces from the Category pop-up menu, or click Flourish.

Frame or Flourish

Select a frame or flourish from one of the sets in the Frames dialog.

Flourish

Choose a position for the Flourish:

Above: Place the flourish above the name.

Below: Place the flourish below the name.

Duo: Place vertically mirrored flourishes above and below the name.

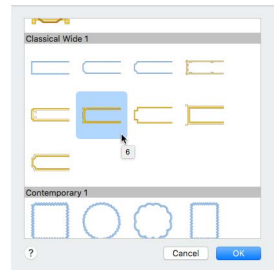

Thread Colors

Set the Thread Color to use when embroidering the frame. Click one of the thread color blocks to open the Color Selection dialog. See “Color Selection Dialog” on page 79.

Stitch Type

Use the Stitch Type pop-up menu to alter the appearance of the stitching used in the frame.

Note: Changes made to the stitch properties for a frame set are retained until a new frame set is selected.

- To change the Stitch Type, select a stitch type from the pop-up menu to open the properties dialog for the stitch type. See “Choosing Stitch Properties” on page 462.

Go Back

Go to the Lettering page.

Note: Alternatively, click the Lettering tab.

Continue

Go to the Connectors page.

Done

Accept the final family tree and close the Family Tree Assistant.

Cancel

Close the Family Tree Assistant without creating a family tree.

Connectors

Use the Connectors page to choose the line type and color for connectors between family members, or to use no connectors; and use single or double line connectors for partners.

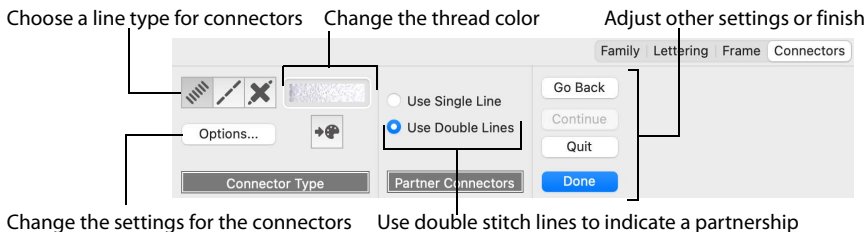

Note: A single running stitch line is used between partners when No Line is selected.

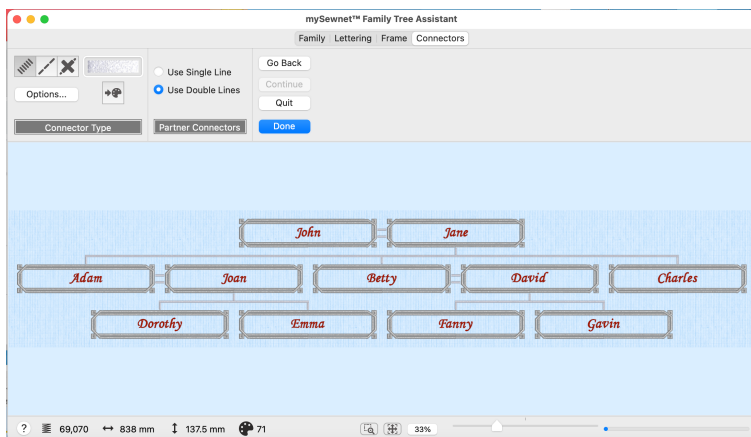

Select a satin line or running stitch line for connectors between family members, or use no connectors. Choose the thread color used for all connectors. Choose a single or double line connector for partners.



Connector Type

Choose Satin Line  or Running Line  for connectors between family members, or choose No Line  to place connectors only between partners.

Note: If No Line is selected for connectors between family members, a single running stitch line will be placed between partners.

- Click Options to set the stitch properties for the family connector lines. The properties dialog for the stitch type opens. See “Satin Line” on page 504 and “Running Stitch” on page 501.

- Click Thread Color  to set the color for all connectors in the Color Selection dialog. See “Color Selection Dialog” on page 79.

Partner Connectors

Choose Use Single Line to place a single line connector between partners, and choose Use Double Lines to place a double line connector between partners.

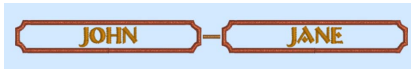

Use Single Line

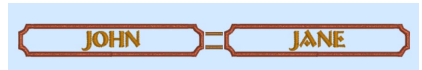

Use Double Lines

Go Back

Go to the Frame page.

Note: Alternatively, click the Frame tab.

Done



Accept the final family tree and close the Family Tree Assistant.

Cancel

Close the Family Tree Assistant without creating a family tree.

Create a Family Tree Embroidery

Note: Before you start, run Reset All Apps in mySewnet™ Configure  to use the initial settings for the fonts, frames and connectors in the family tree embroidery.

- 1 In the Create window  of the Control Panel , click Family Tree Assistant. Alternatively, choose Assistants > Family Tree Assistant. The Family page opens.
- 2 In the Family page, select Ancestors Chart .
- 3 In the First Individual dialog, in Given Name, enter "John". In Family Name enter "Green".
- 4 Ensure that Gender is set to Male and click Continue.

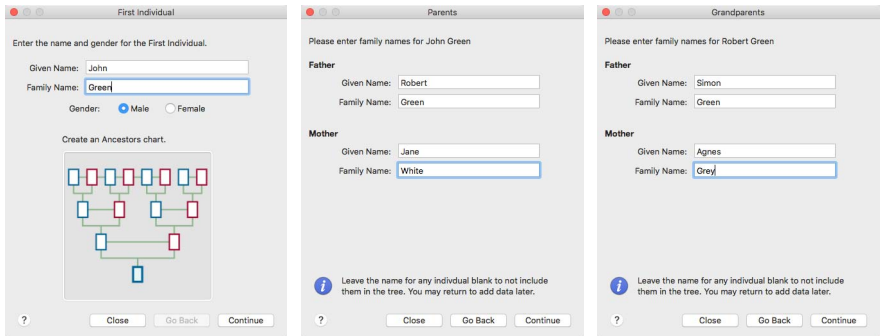

- 5 In the Parents dialog, enter "Robert" as the Given Name for Father.
- 6 For Mother, enter "Jane" as the Given Name and "White" as the Family Name. Click Continue.
- 7 In the Grandparents dialog for Robert Green, enter "Simon" as the Given Name for Father, and "Agnes" and "Grey" as the Given Name and Family Name for Mother. Click Continue.
- 8 In the Grandparents dialog for Jane White, enter "Thomas" as the Given Name for Father, and "Susan" and "Black" as the Given Name and Family Name for Mother.
- 9 Click Close to finish entering names for the family tree.

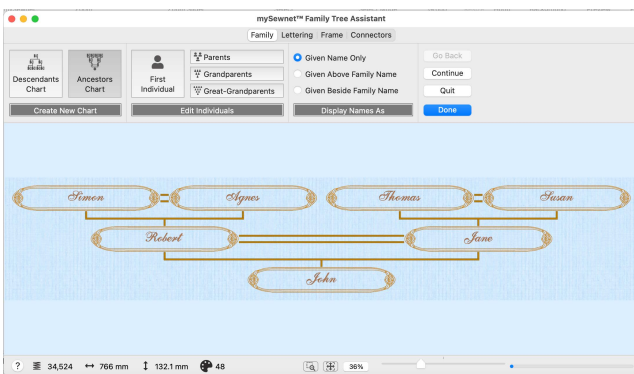

Note: When you click Close the family tree is saved. If you shut down mySewnet™ Embroidery, and then reopen it and the Family Tree Assistant, the family tree you entered is displayed.

- 10 Click to select Given Beside Family Name. The family names are now also displayed.

Note: At the bottom of the Family Tree Assistant window the number of stitches and the design dimensions change. Use this to check whether the design will fit in the desired hoop.

- 11 Click Grandparents . The Grandparents dialog for Robert Green is opened.
- 12 Click Continue to view the other Grandparents dialog.
- 13 In the Family Name field for Mother, change "Black" to "Brown". The family tree design behind the dialog is updated with the name Susan Brown.

Note: You can correct mistakes and add information to the family tree after creation.

- 14 Click Close.

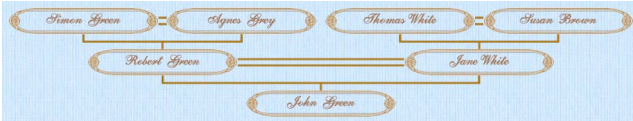

The family tree design is rather wide. To use the design on a cushion or in a frame, a taller format would look better.

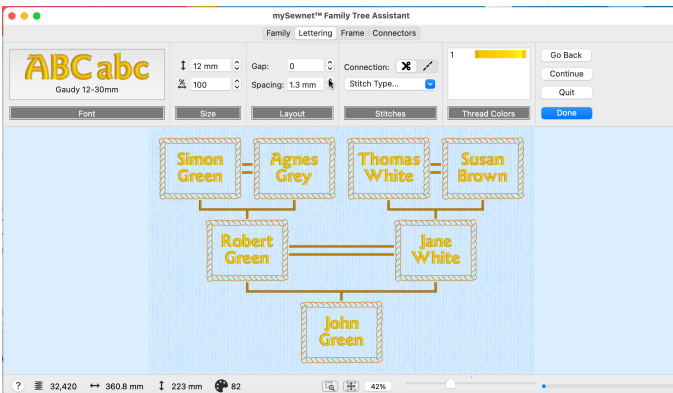
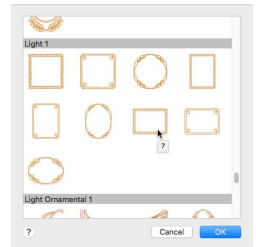

- 15 Click Given Name Above Family Name. The design is now even wider! These frames were better suited to the side by side format.
- 16 Click the Frame tab.
- 17 Click the displayed frame in the Frame or Flourish area to see the Frames viewer.
- 18 Browse to the Light I category and select the rectangular horizontal frame 7 to change the design proportions. Click OK.
- 19 Select the Lettering tab to change the font.
Note: The Adina font used in the assistant theme is brown rather than the standard pink, and is used at Size 12mm.
- 20 For a more contemporary look, click the displayed font, and in the font viewer browse to the Modern Category and select Gaudy 12 - 30mm. Click OK.
Note: This is the same size as the Adina font previously used.
- 21 The top and bottom lines of lettering touch with some names. Click the up arrow for Spacing once, to set it to 1.3.

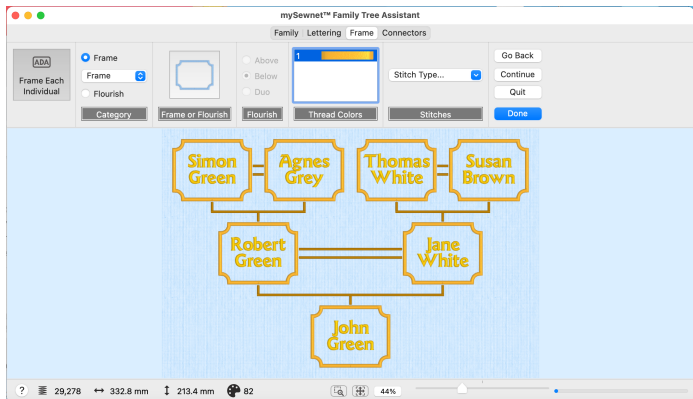

- 22 Select the Frame tab again to choose a satin frame to go with the lettering.
- 23 Click the displayed frame in the Frame or Flourish area, and in the Frames viewer browse to the Classical I category.

- 24 Select frame 9 and click OK.
- 25 Click the blue thread color, and in the 'find thread' field in the Color Selection dialog enter the number 2216. Select Robison-Anton Rayon 40, 2216 Marigold and click OK.



- 26 Select the Connectors tab.
- 27 The connectors are too prominent. Click Thread Color  and in the 'find thread' field in the Color Selection dialog enter the number 2408.
- 28 Select Robison-Anton Rayon 40, 2408 Star Gold. (This is the color used by the lettering.) Click OK.
- 29 In Connector Type, select Running Stitch .

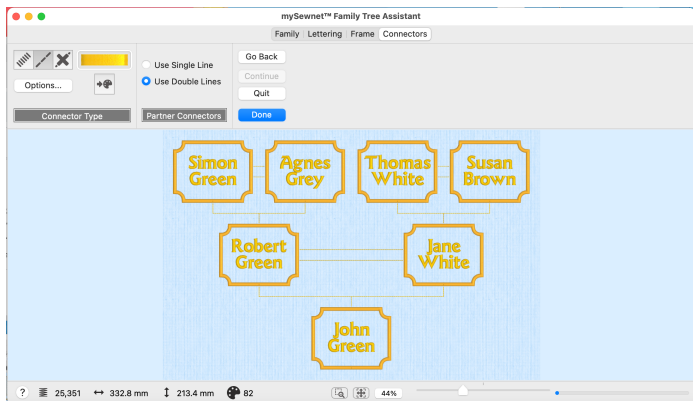

Note: Alternatively, you could have changed the width and density of the satin line connectors with Options.

- 30 Click Done to place the family tree chart in the work area as a grouped .vp4 file with fixed lettering and frames.
- 31 Click Hoop , and in the Hoop Selection dialog deselect Enter Hoop Size.
- 32 In the Universal Hoop Group, set the Hoop Size to 360mm x 260mm - Universal Large Hoop 5, Rotated orientation. Click OK.



Note: You could also use the Split Project to split the design for a smaller hoop.

When you next open mySewnet™ Embroidery, your family tree will be available for further editing, or to create a completely different embroidery design.



Use the ExpressMonogram Assistant to create a monogram of up to three letters, selecting a font style, thread color, shape and size. If desired, add a border.

Use the ExpressMonogram Assistant  to create a monogram of up to three letters from a set of initials, choosing a font style, thread color, shape and size. Surround the monogram with a border, or create a monogram with no border and add a Frame or Flourish in the Frame window, or a motif underline in the Border window.

Create a monogram

- In the Create window  of the Control Panel  click ExpressMonogram Assistant.
- Choose Assistants > ExpressMonogram Assistant.

Use the ExpressMonogram Assistant

- 1 In the Create window  of the Control Panel  click > ExpressMonogram Assistant . Alternatively, choose Assistants > ExpressMonogram Assistant.
- 2 Select a monogram type.
- 3 Step through the rest of the ExpressMonogram Assistant.
Note: Progress through the pages using Continue and Go Back, or click Done at any time.
- 4 When you finish, the new monogram embroidery is in the center of the hoop.
Note: Any existing monogram or background is retained in the work area.
- 5 Use Save, then Export to keep the new embroidery.

ExpressMonogram Assistant

Use the ExpressMonogram Assistant to create a monogram from a set of initials. The Monogram page of the ExpressMonogram Assistant appears.

Select a font style, thread color, shape and size. Surround the monogram with a border. Alternatively, create a monogram with no border, then add a Frame or Flourish in the Frame window, or a motif underline in the Border window.

Create a Monogram

- In the Create window  of the Control Panel  click ExpressMonogram Assistant . Alternatively, choose Assistants > ExpressMonogram Assistant. The Monogram page opens.

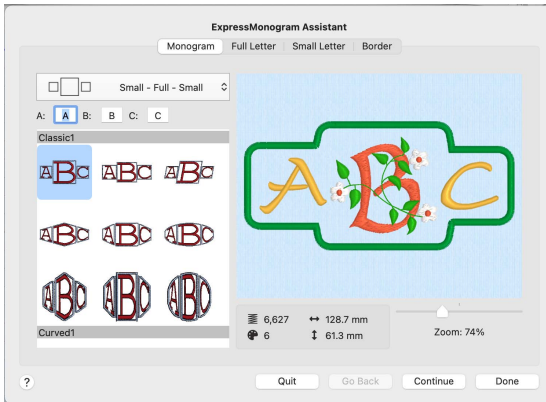

- Choose a monogram type from the pop-up menu on the left. Select how many letters to use, and whether they are Full or Small.
Note: The size of a Small letter is proportional to the Full monogram letter. You can use different fonts and colors for Small letters.
- Enter the letters for your monogram in the boxes A, B and C.
If the box for the letter is blank, a question mark is inserted instead.
Note: For traditional monograms, letters are used in the order of given name, family name, middle name.
- Select a monogram Envelope category and type from the scrolling window. All the envelopes available use the number of Full and Small letters that you have chosen. Choose an Envelope that uses the desired size ratio for your Full and Small letters.
Note: You can return to this page later if you want to adjust the choices you made.

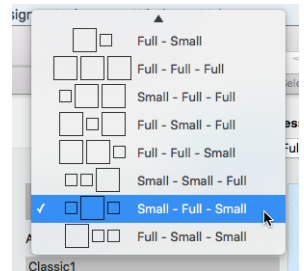

- 5 Click Continue. The Full Letter page appears.

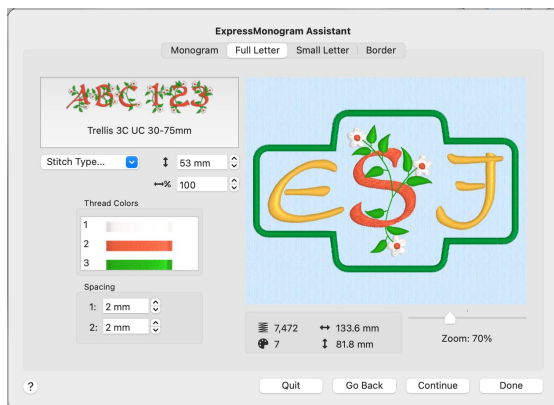

Adjust the style and size of the large letters in the monogram, and the space between all letters in this page.

- 6 Click the displayed font to select a font from the scrolling window. For example select the font Curly UC 15-30mm in the Monogram Category in the displayed list of fonts.

Note: The Monogram fonts are recommended for use with the Classic envelopes that use SFS (small, full, small characters), as they are designed with mainly even width characters.

- 7 Select a Height \updownarrow for the letter(s).

Note: For best results, choose a size within the recommended range shown in the font name. The size is initially set to the middle of this range.

- 8 Change Percent Width \rightleftarrows to make the letters wider or narrower.

The Width setting is a proportion of the overall size.

Check the size in the design information as you progress, to be sure that the embroidery will fit in the desired location.

- 9 Use Spacing 1 and Spacing 2 to adjust the amount of space in millimeters between the letters. Use negative values to interlock letters, if desired.

You may need to adjust the spacing after selecting the font for the small letters.

Note: Spacing will affect whether individual borders are created around the letters in the monogram.



- 10** Click on a thread color to display the Color Selection dialog. Here you can select another shade by clicking on it, or by entering the thread number in the Find Thread text box. Click OK to close. In the Stitch Type pop-up menu you can change the properties for the stitching in the font. The pop-up menu may be dimmed (unavailable), depending on which stitch types are present in the font.
- 11** Click Continue. If you selected a monogram that included small letters, as well as large ones, the Small Letter page appears. Otherwise the Border page will appear.

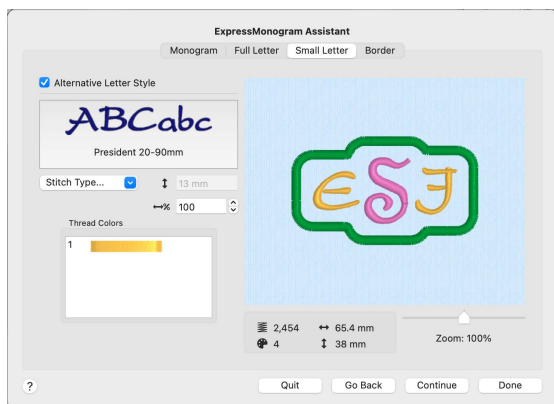
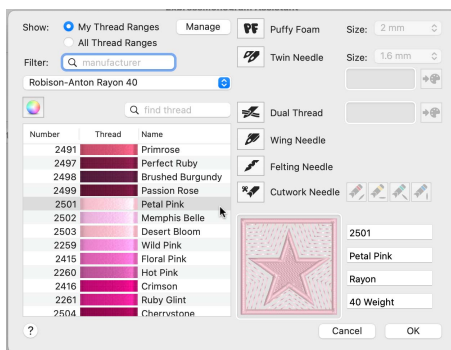

- 12** In this page, adjust the style and color of the small letters in the monogram.
Note: Deselect 'Alternative Letter Style' to use the same font, color and thread as for the Full letters.
- 13** Click Continue. The Border page appears.
- 14** Increase Margin to give more room around the letters (the amount of space around letters is also affected by the Spacing settings in the Full Letter page).
- 15** Choose whether to use rounded corners and individual letter borders for the monogram letters.
Note: The individual borders will only show if there is enough space between the letters.

16 Select a Stitch Type, and use Options to set its properties.

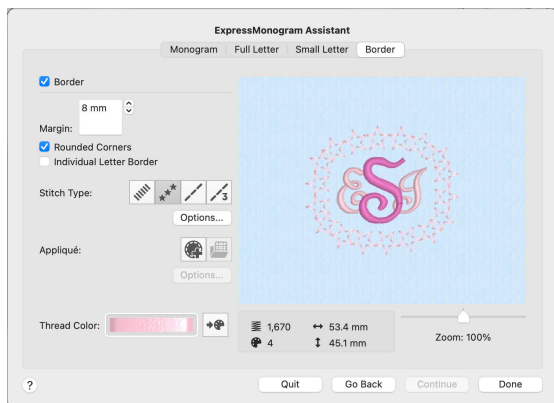

Note: You can also change the border thread color.

- 17** Click Done to close the assistant and place the embroidery in the work area.
- 18** Use Save to save the monogram as a multipart embroidery in .vp4 format.
- 19** To adjust the monogram further, Insert or Open the saved monogram, then Control-click and choose Properties. The monogram is opened in the ExpressMonogram Assistant.

Monogram

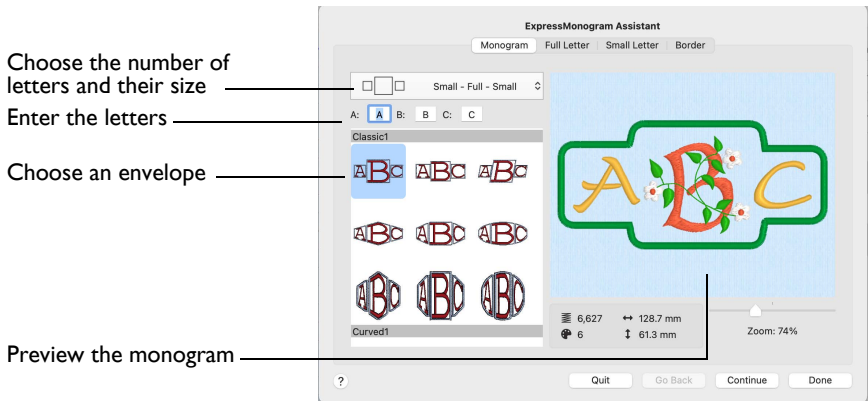

Use the Monogram page to select the number and size of letters for the monogram, enter the letters, and to choose an envelope category and type. View your choices in the preview.

Note: For traditional monograms, letters are used in the order of given name, family name, middle name, with the family name as a large character in the middle: SFS (small, full, small).

Choose Letters

- In the pop-up menu, choose the number of letters and their size (Small or Full). Then enter the initials for the monogram in boxes A, B and C.





Note: If you use a Monogram font, only upper case letters are used in the embroidery, even if you entered lower case letters.

Envelope

- Select an envelope category and type from the scrolling window.

Note: The envelope that you choose affects the relative size of the full and small letters. For example, the small letters in the Small, Full, Small (SFS) Straight1 category are relatively smaller than those in the SFS Straight2 category.

Preview

A preview of the embroidered monogram, and its stitch count , width , height  and number of color blocks  is displayed.

Zoom

Use the Zoom bar to change the view of the picture. Zoom in (drag the slider to the right) to magnify the view. Zoom out (drag the slider to the left) to shrink the view.

When zoomed in, use the scroll bars or swipe to move around.

Quit

Close the ExpressMonogram Assistant without creating a monogram.

Continue

Go to the Full Letter page.

Note: Alternatively, click the Full Letter button.

Done

Accept the final design and close the ExpressMonogram Assistant.

Full Letter

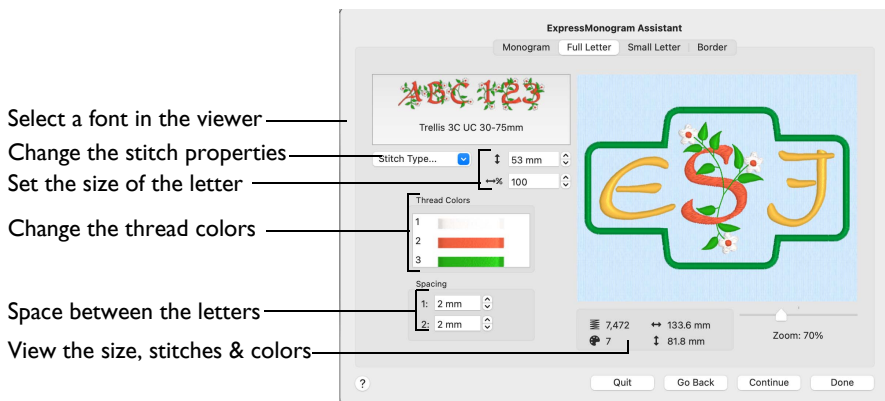

Use the Full Letter page to select how the large letters in the monogram are displayed. Select the font, size, stitch type, thread color and spacing of the letters.

Font

Use the font area to view fonts, and choose a font.

The font name specifies the recommended size range for each font. The initial font size for Full letters is in the middle of the recommended range.

Note: The Monogram fonts are recommended for use with the Classic envelopes that use SFS (small, full, small characters), as they are designed with mainly even width characters.

Select a Font

- Click the displayed font, and choose a font in the font viewer.

Stitch Type

Use **Stitch Type** to change the properties for the stitch types in the font in the properties dialog for that font. See “Choosing Stitch Properties” on page 462.

- In the **Stitch Type** pop-up menu, choose one of the stitch types for the font. Use the properties dialog to adjust the settings for that stitch type, then click **OK** to apply your changes.

Note: The **Stitch Type** pop-up menu is only available if the font contains at least one stitch type with editable properties.



Height

Height  sets the height of the 'A' character in the font. All other characters and symbols are sized relative to the height of 'A'. The size is initially set to a medium size for the chosen font.

- Click the arrows or enter a value in the Number box to set Height from 3mm to 200mm.

Width

Width sets the Width percentage  of the Full letters, relative to the default size.

- Click the arrows or enter a value in the Number box to set Width percentage from 25% to 400% of the default setting.

Spacing

Set the distance between the letters in the monogram. Spacing 1 sets the distance between the first and second letters, Spacing 2 sets the distance between the second and third letters. You can use negative values to interlock letters.

Note: Spacing will affect whether individual borders are created around the monogram letters when a border is used.





- Click the up and down arrows or enter a value in the Number box to set Spacing 1 and Spacing 2 from -51.0mm to 51.0mm.

Thread Colors

Set the Thread Colors for the letters. The thread sample and preview are updated with the selected color.

- Click a thread to choose a different color in the Color Selection dialog. See “Color Selection Dialog” on page 79.

Preview

A preview of the embroidered monogram, and its stitch count , width , height  and number of color blocks  is displayed.

Zoom

Use the Zoom bar to change the view of the picture. Zoom in (drag the slider to the right) to magnify the view. Zoom out (drag the slider to the left) to shrink the view.

When zoomed in, use the scroll bars or swipe to move around.

Quit

Close the ExpressMonogram Assistant without creating a monogram.

Go Back

Return to the Monogram page.

Continue

Go to the Small Letter page if you are also using small letters, otherwise go to the Border page.

Done

Accept the final design and close the ExpressMonogram Assistant.

Small Letter

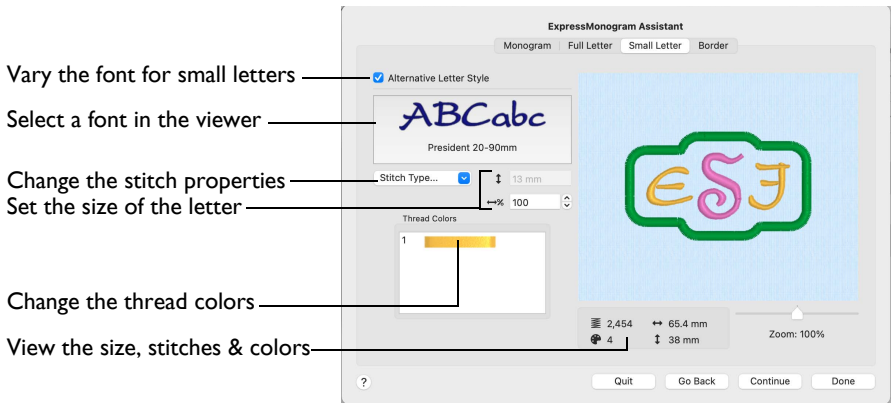

Use the Small Letter page to select how the small letters in the monogram are displayed. Select the font, percentage width, stitch type and thread color of the letters.

Note: The relative size of the small and large letters is set by the envelope selected in the Monogram page. To check that your small letters are within the recommended range, look at the Height for the small letters. Small letter height can be viewed, but not edited.

The Small Letter page only appears if you selected an envelope with small letters in the Monogram page.

Alternative Letter Style

If Alternative Letter Style is selected, the small letters in the monogram can use a different font, color and size from the full letters. This option is selected by default.

Note: If this option is deselected, the color and style of the small letters in the monogram are identical to the large letters, and all other options on this page are dimmed (unavailable).

Font

Use the font area to view and choose a font.

The font name specifies the recommended size range for each font.



Select a Font

- Click the displayed font, and choose a font in the font viewer.

Stitch Type

Use **Stitch Type** to change the properties for the stitch types in the font in the properties dialog for that font. See “Choosing Stitch Properties” on page 462.

- In the **Stitch Type** pop-up menu, choose one of the stitch types for the font. Use the properties dialog to adjust the settings for that stitch type, then click **OK** to apply your changes.

Note: The **Stitch Type** pop-up menu is only available if the font contains at least one stitch type with editable properties.

Height

Use **Height**  to view the height of the small letters.

Note: The height given is that of the 'A' character in the font, as calculated from the **Full Letter** size and the selected envelope. All other characters and symbols are sized relative to the height of 'A'

Width

Width sets the **Width percentage**  of the Small letters, relative to the default size.

- Click the arrows or enter a value in the **Number** box to set **Width percentage** from 25% to 400% of the default setting.

Thread Color



Set the **Thread Colors** for the letters. The thread sample and preview are updated with the selected color.

- Click a thread to choose a different color in the **Color Selection** dialog. See “Color Selection Dialog” on page 79.

Match Full and Small Letter Colors

- 1 To match the color of a Small letter to a Full letter, open the **Full Letter** page and click the desired thread color.
- 2 Note the thread name and number from the **Color Selection** dialog.
- 3 Go to the **Small Letter** page.
- 4 Click the thread color to be changed, enter the color number for the other color in the **Find Thread** box, and click **OK**. The colors will now match.

Preview

A preview of the embroidered monogram, and its stitch count , width , height  and number of color blocks  is displayed.

Zoom

Use the Zoom bar to change the view of the picture. Zoom in (drag the slider to the right) to magnify the view. Zoom out (drag the slider to the left) to shrink the view.

When zoomed in, use the scroll bars or swipe to move around.

Quit

Close the ExpressMonogram Assistant without creating a monogram.

Go Back

Return to the Full Letter page.

Continue

Go to the Border page.

Done

Accept the final design and close the ExpressMonogram Assistant.

Border

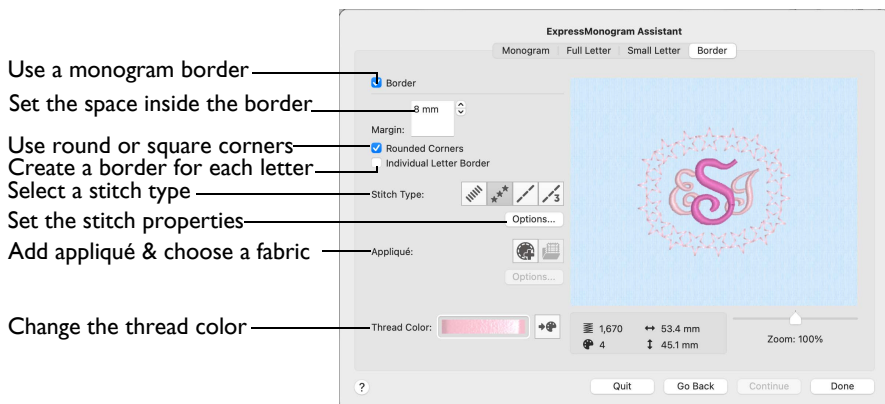

Use the Border page of the ExpressMonogram Assistant to place a border around the monogram, and to select the thread color for the border.

The border can have rounded or square corners, and letters can be bordered individually. The available border types are satin line, running stitch, triple stitch and motif line. The Options button is used to set the stitch properties.

Margin

Use Margin to set the distance between the monogram and the border around it.

- Click the arrows or enter a value in the Number box to set Margin from zero to 20mm.

Rounded Corners

Use rounded or square corners for the border around the monogram.

- Select Rounded Corners to smooth the corners of the monogram border.

Individual Letter Border

Use Individual Letter Border to place a border between the individual letters in the monogram.

Note: Borders will not appear between the letters in the monogram if they are too close together.



- Select Individual Letter Border to place a border around each letter.
- To make the individual letter borders visible, go to the Full Letter page and increase Spacing 1 and Spacing 2. Then return to the Border page.

Stitch Types

The stitch types available for automatically created borders are:



- Satin Line: see “Satin Line” on page 504.
- Motif Line: see “Motif Line” on page 506.

- Running Stitch: see “Running Stitch” on page 501.
- Triple Stitch: see “Triple Stitch” on page 503.

- Select a stitch type, then click Options to set the properties for the selected stitch type.

Appliqué

Add appliqué to the monogram and select a fabric.





- Click Add Appliqué  to use appliqué, and then click Select Fabric  to change the fabric. Click the Options button to select an Appliqué Method. See “Creating Appliqué Areas” on page 184.

Thread Color

Use Thread Color to select the color used for stitching the monogram border.

- Click Thread Color . The Color Selection dialog opens. See “Color Select” on page 78.

Preview

A preview of the embroidered monogram, and its stitch count , width , height  and number of color blocks  is displayed.

Zoom

Use the Zoom bar to change the view of the picture. Zoom in (drag the slider to the right) to magnify the view. Zoom out (drag the slider to the left) to shrink the view.

When zoomed in, use the scroll bars or swipe to move around.

Quit

Close the ExpressMonogram Assistant without creating a monogram.





Go Back

Return to the Small Letter or Full Letter page.

Done

Accept the final design and close the ExpressMonogram Assistant.

Create a Monogram with a Border

- 1 If required, choose File > New.
- 2 Click the Hoop button  and set the hoop size to 100mm x 100mm - Universal Square Hoop I. See “Hoop Selection” on page 22.
- 3 In the Create window  of the Control Panel  click ExpressMonogram Assistant . Alternatively, choose Assistants > ExpressMonogram Assistant. The Monogram page of the ExpressMonogram Assistant appears.

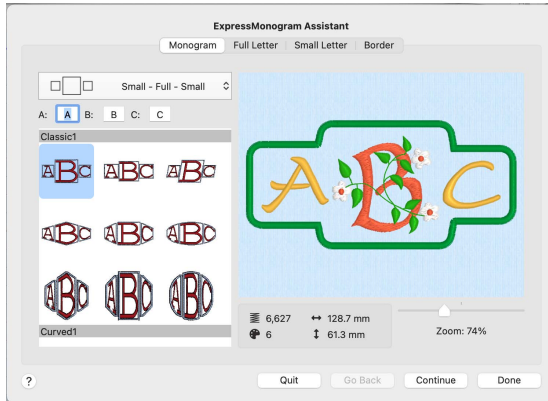

- 4 In the pop-up menu at the top left, choose the Small - Full - Small layout. This will produce a monogram with characters sized proportionally: small, full, small (SFS).
- 5 Enter the letters 'E', 'S' and 'J' in boxes A, B and C.
Note: E, S and J represent the name Elizabeth Jane Smith, using traditional monogram style where letters are used in the order of given name, family name, middle name. If the letters were all full size, EJS could be used as an alternative.
- 6 In the Envelopes window, choose the second envelope in the Classic category. Its name is SFS_Classic02.

Note: If you position the arrow pointer over a thumbnail without clicking, the name of the envelope is shown. The name stands for Small-Full-Small, using the second envelope in the Classic-I category. In this envelope the small characters are relatively larger than those in the envelope to the left, which will suit the curly initials to be used.

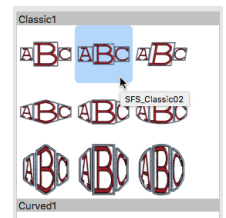
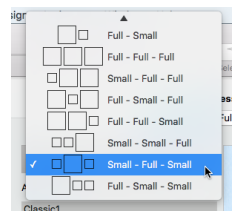

7 Click Continue, or click the Full Letter button. The Full Letter page appears.

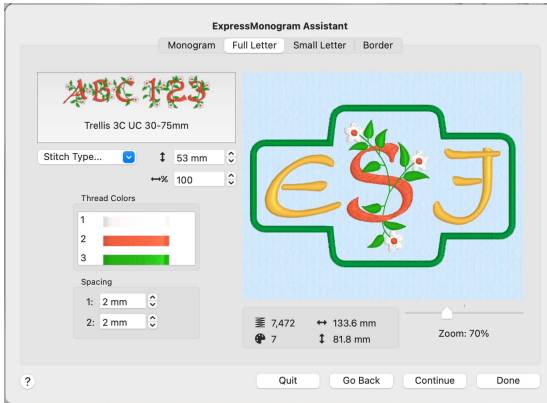

8 Click the displayed font, and scroll down to see the fonts in the Monogram category.

Note: This category includes fonts that are recommended for the Classic envelopes using SFS (small, full, small characters).

9 Click to select the font Curly UC 15-30mm, then click OK to close the viewer.

10 Leave the font size at 22mm.

The initial size of a font is midway in the font size range.

11 Note that the Height ↑ and Width ↔ measurements below the preview have changed.



Use these dimensions as a guide to the size of your final monogram as you try different options. If you have a desired final size you may need to alter the font size, or the border.

12 Click the pink thread, and in the Color Selection dialog choose Robison-Anton Rayon 40 in the Thread Range pop-up menu. The thread changes to Floral Pink, number 2415. Click OK.



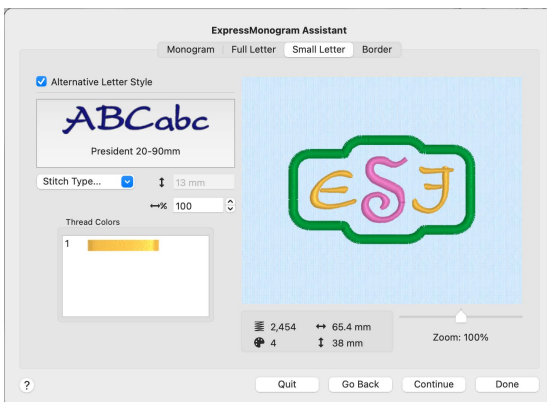

Note: This only affects the letter S, as it is the only 'Full' letter.

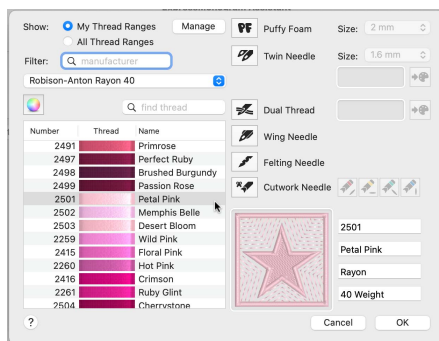

13 Click Continue, or click the Small Letter button, and the Small Letter page appears.



- 14 Ensure that 'Alternative Letter Style' is selected.
 Note: If Alternative Letter Style is not selected, the same font and color are used for small letters and the full letters.
- 15 In the Font viewer enter "Curly" in the Search  box. Two Curly fonts are shown.
- 16 Click to select Curly UC 15-30mm, then click OK to use it for the small letters.
- 17 Note that the Height  measurement below the font viewer has changed. This is the height of the letter 'A' for the small letter font. It should be within the recommended size range for the font (as mentioned in the font name). If the height is outside the recommended range, you may need to return to the Monogram page and change the envelope, or use the Full Letter page to change the full letter size
- 18 Click the pink color and the Color Selection dialog appears.
- 19 In the Thread Range pop-up menu choose Robison-Anton Rayon 40.
- 20 Scroll up and choose color 2501 (Petal Pink).
- 21 Click OK. The smaller letters are now a pale pink.
- 22 Click Continue, or click the Border button, and the Border page appears.



You can use a Motif Line , a Satin Line , or a Running Stitch  or Triple Stitch  line. You can also add appliqué fabric to the monogram.

- 23 Select Motif Line . The solid green border is replaced by a line of stars.
- 24 Select Satin Line  and the satin stitches appear again.
- 25 Click the Thread Color button  to display the Color Selection dialog.



- 26 Ensure that 'Robison-Anton Rayon 40' is selected.
- 27 In Find Thread enter 2501 and choose color 2501 (Petal Pink).
- 28 Click OK to close the Color Selection dialog. The satin border of the monogram is now pink.

- 29 Click the 'Individual Letter Border' checkbox to place lines between the letters in the monogram.
- Note:* Although 'Individual Letter Border' is now checked, borders do not appear between the letters as they are relatively closely spaced.

- 30 To see individual letter borders in the monogram, the spacing must be increased. Click the Full Letter button to return to the Full Letter page.





- 31 Click the up arrow in Spacing 1 to increase the gap to 15mm. (This is the distance between the first and second letters.)
- 32 Click the up arrow in Spacing 2 to increase the gap to 15mm. (This is the distance between the second and third letters.)
- The letters now have individual borders. This format may be desired when embroidering badges.

Note: If you position the arrow pointer over a measurement box without clicking, the alternative measurement is shown. You may also enter the alternative measurement with units of mm or " (including fractions) and it will be automatically converted.

- 33 For a traditional monogram effect, the letters may interlock. Set Spacing 1 to -3 mm, and set Spacing 2 to -4 mm.

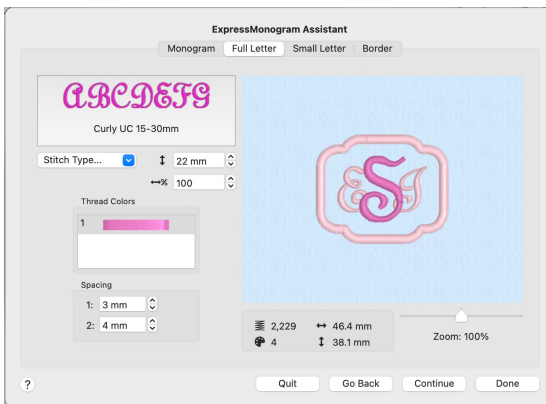
The new positions of the letters can be seen in the Preview. The border adjusts to fit.



- 34 Click Done to close the assistant. There is a brief delay while overlap removal calculations occur, and the design is ColorSorted. The monogram is then displayed in the work area. (The density of the overlapping letters is quite low, so in this case no stitches are removed.)
- 35 Ensure that the Control Panel button  is open at the Design window.

36 Click Settings. The settings information appears in the Settings box.

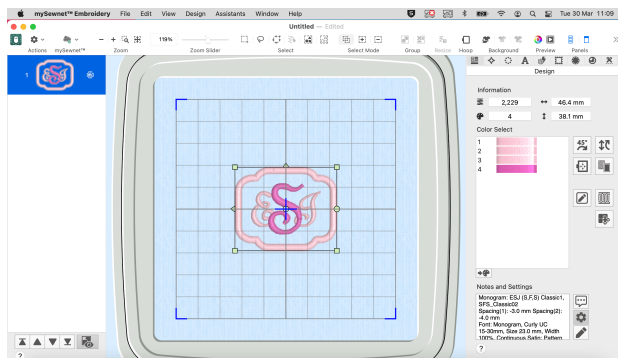

37 Click Edit to see all of the text.

Note: The Settings give information on the letters, dimensions and font used in the monogram, including the font size for the large letter, and any patterns and fills used. This information can be used to recreate the monogram later, if necessary.

Click the Edit button if you wish to edit these notes. The Settings dialog is displayed. Amend the Settings as desired, then click OK to save your edits.

38 Click Actions  on the toolbar and choose Save, or press ⌘S.

Note: This will save the monogram as a multipart .vp4 file. When you open or insert this file in the work area, Control-click and choose Properties to open it in the ExpressMonogram Assistant.

39 Click Actions  on the toolbar and choose Export, or press ⌘⌘S.



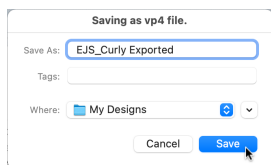

40 In the Export dialog, ensure that .vp4 is selected and click Continue.

41 In the saving as dialog, browse to mySewnet/My Designs, and save the embroidery as EJS_Curly. This saves a version ready for stitching out.



Note: You could use the Background Assistant to preview the use of this monogram on a blouse or towel. See “Backgrounds” on page 53.

Create a Two Letter Monogram

- 1 If required, choose File > New.
- 2 Click the Hoop button  and set the hoop size to 150mm x 150mm - Universal Square Hoop 2. See “Hoop Selection” on page 22.
- 3 In the Create window  of the Control Panel  click ExpressMonogram Assistant . Alternatively, choose Assistants > ExpressMonogram Assistant. The Monogram page of the ExpressMonogram Assistant appears.
- 4 In the pop-up menu at the top left, choose the Full - Full layout. This will produce a monogram with two equal sized characters: full, full (FF).
- 5 Enter the letters 'A' and 'D' in boxes A and B.

- 6 In the Envelope window, scroll down to the third envelope in the Straight I category. Its name is FF_Straight03.

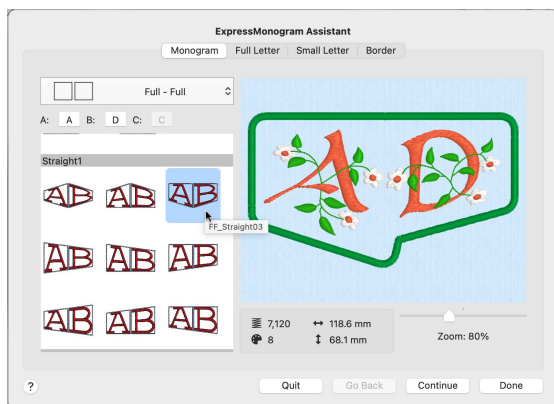

This is for Full-Full, using the third envelope in the Straight I category.

- 7 Click Continue, or the Full Letter tab.
- 8 Click the Font Display, the font Viewer opens.
- 9 Scroll to the Display section.
- 10 Click to choose the font Revue UC 25-120mm MW, then click OK. The MW suffix indicates that this font uses a MultiWave Fill.
- 11 Leave the font size at 72mm.

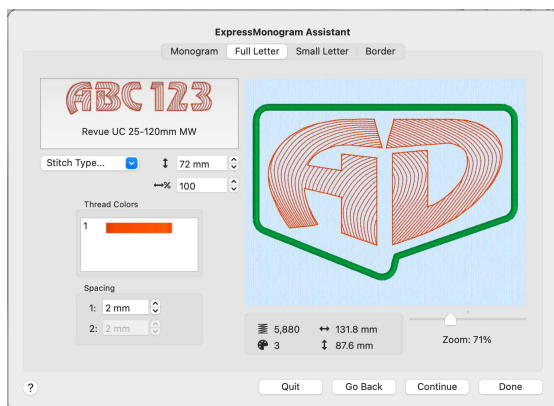



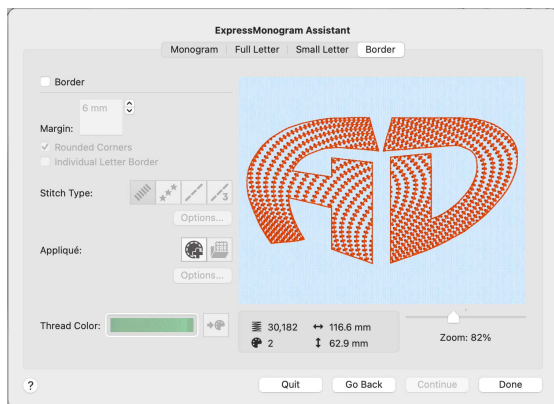
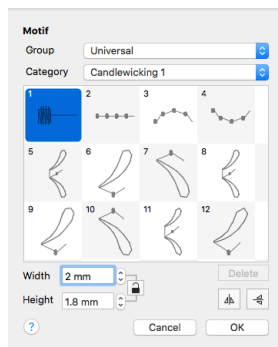

- 12 In the Stitch Type pop-up menu, choose MultiWave Fill. The MultiWave Fill options dialog appears.
- Note: Use the MultiWave Fill options dialog to edit the properties of the fill for this font.
- 13 Select the Use Motifs checkbox.

- 14 Click the Motif button. The motif dialog appears, with the motif set to a star.
- 15 Set the Group to Universal and the Category to Candlewicking 1.
- 16 In the pattern viewer, ensure that Pattern 1 is selected.
- 17 Check that Non-proportional  is selected (lock open).
- 18 Set the Height to 1.8mm, and the Width to 2.0mm.
- 19 Click OK twice to close the Motif dialog and the MultiWave Fill options dialog.
The fill now has a striking candlewick pattern.
- 20 Ensure that Spacing 1 is set to 2mm.
Note: As there are only two letters, Spacing 2 is dimmed (unavailable).
- 21 Click Continue. The Border page appears.
Note: As there are no small letters, the Small Letter page is not displayed.
- 22 Deselect the Border checkbox to remove the border around the monogram.



- 23 Click Done to close the assistant. The monogram is displayed in the mySewnet™ Embroidery work area.
- 24 Click Actions  on the toolbar and choose Save, or press \mathbb{S} .
- 25 Save the monogram as the file AD.vp4 in mySewnet/My Designs.
Note: This will save the monogram as a multipart .vp4 file. When you open or insert this file in the work area, Control-click and choose Properties to open it in the ExpressMonogram Assistant.
If desired, you can add a frame to the monogram in the Frame window. See “Creating Frames, Borders and Underlines” on page 445.

This chapter describes how you can use the Lettering window to personalize your embroidery project with the fonts available in mySewnet™ Embroidery.

In the Letter window you can create lettering to personalize your embroidery project using single or multicolor fonts (lettering styles) and fonts of special characters. Alternatively, use the ExpressMonogram Assistant. Use Font Manager  to search for fonts by name or size, and to create, rename, duplicate and delete user generated fonts. Use QuickFont  to create new fonts for mySewnet™ Embroidery from most TrueType® or OpenType® fonts on your computer. Import embroidered letters to create a font with Import Font From Embroideries . Use Name Changer  to create a series of embroideries with varied lettering automatically from a template.

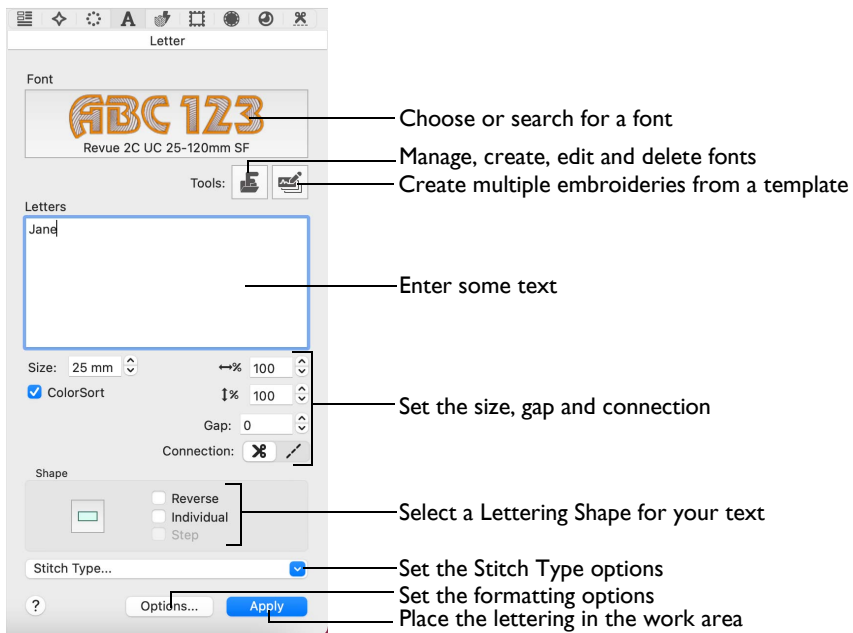

Choose the font, line format, size, stitch type and thread color. Place lettering around your embroidery, or anywhere on the work area. Lettering can be resized with constant stitch density, and the stitch properties adjusted, until it is fixed as embroidery.

To Open the Letter Window

- Click Control Panel, then click Letter .

To learn how to	Go to
Create Lettering	See “Create Lettering” on page 356.
Set properties for new lettering	See “Setting Letter Options” on page 381.
Use the font viewer	See “Font Viewer” on page 358.
Use Block lettering to sculpt text	See “Using Block Lettering” on page 380.
Change an existing block of lettering	See “Changing Letter Properties” on page 398.
Check the spelling in your lettering	See “Check Your Spelling” on page 364.
Add special characters, e.g. accents	See “Emoji and Symbols” on page 365.
Enter letters in an alternative alphabet, e.g. Greek	See “Alternative Alphabets” on page 365.
Create and adjust circles of lettering	See “Using Circular Lettering Shapes” on page 368.
Use straight and wavy lettering lines	See “Fit Lettering to a Line” on page 369.
Place a full circle of lettering around an embroidery	See “Full Circle Lettering: I Love the Sunshine” on page 391 and “Let’s Go Fishing” on page 392.
Create a monogram from individual letters	See “Individual Letter Monogram” on page 394.
Change lettering colors	See “Change the Colors in Lettering” on page 399.
Create a monogram with a border automatically	See “Create a Monogram with a Border” on page 348.
Create your own embroidered font	See “QuickFont” on page 401.
Import embroideries to form a font	See “Import Font from Embroideries” on page 385.
Create, rename and delete personal fonts	See “Font Manager” on page 382.
Create a series of embroideries with varied lettering from a template	See “Name Changer” on page 433.

Create Lettering

- 1 Open the Letter window **A**.
- 2 Click the displayed font, and scroll up or down the Font Viewer to select a font. For more information on fonts, see “About Fonts” on page 359.

3 Set the Size in millimeters as desired, from 3mm to 200mm.

This sets the height of the 'A' character in the font. Other characters and symbols are sized accordingly. See “Font Size” on page 362.

4 Set the proportions, the gap between the letters, and the connection type (trim or running stitch).

5 Click in the Letters text box and the pointer becomes an I-beam.

If needed, drag to highlight any existing text and overwrite it.

6 Enter your desired text, pressing Option–Return to create more than one line of text.

Control–click to view alternatives for words underlined in red by the spelling checker.

Note: Some Lettering Shapes can only use one line of text. See “Lettering Shapes” on page 366.

7 Choose a Lettering Shape. See “Using Block Lettering” on page 380.

You can reverse the order of letters, position (or kern) letters individually, or use Step to rotate the letters at a different angle from the line. See “Fit Lettering to a Line” on page 369.

8 Choose a Stitch Type from the pop-up menu, and edit its properties in the dialog. See “Stitch Type” on page 363.

9 Click Options to change the alignment and line spacing. See “Letter Options” on page 365.

10 Click Apply.

The lettering appears in the work area, leaving any existing lettering unchanged.

11 Control–click the lettering and choose Properties to adjust the lettering properties. See “Letter Properties” on page 396.

12 Drag the handles on the lettering to resize the lettering, or adjust the proportions for the lettering shape. Hold the Shift key for most lettering shapes to keep the proportions as you resize. Hold the Option key for most lettering shapes to resize from the center. See “Lettering Shapes” on page 366.

Note: Alternatively, use the ExpressMonogram Assistant to create a one, two or three letter monogram, and add a border automatically.

Searching for Lettering

1 Open the Letter window **A**.

2 Click the displayed font to open the font menu.

3 To search for a font by name, at the top of the font dialog in the Search box, enter the name of the font or font category that you want to find. Note: Part of the name will narrow the list of fonts displayed, so a search for 'Athletic' will display fonts from the Applique, Foam, Fun and Monogram Categories.

4 Click clear **✕** to remove the text from the search box.

5 To search for a font by size, select (check) the Size checkbox to enable searching by size.

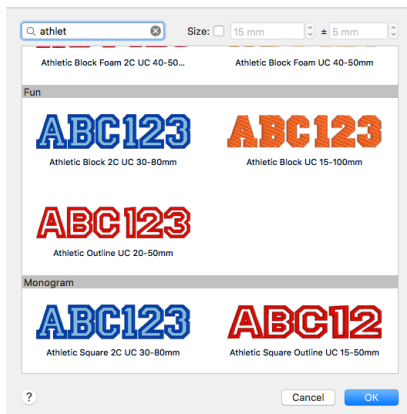

- 6 Enter the desired Size for the font in the Size number box.
- 7 To choose a size range, adjust the number in the Range \pm box. The list of displayed fonts will change.
For example, set Size to 5mm, and the Range to 5mm, to select a small font for a quilt label. You could also set an exact size (Range 0mm) to find an imported embroidery font.

Font Viewer

Use the Font Viewer to browse fonts and select a font for lettering.

To Open the Font Viewer

- 1 Open the Letter window **A**.
- 2 Click the font sample.
- 3 Scroll up or down the list of font Categories and fonts to choose a font.
Alternatively, enter a part of a font name in the Search box to search for a font.
- 4 Click on a font to highlight it.
- 5 Click OK to select the font.



Font Search

Use Font Search to search for a font by name or size.

Search for a font by name Search for a font by size Set the size range for the font search



Search

Search for a font by name.

- Enter the desired text in the Search box. Click Clear  to remove the search text.

Note: Click Clear  before searching by Size.

Size

Search for fonts by their recommended size.

- Ensure that the Size checkbox is selected (checked), then enter the desired size in the Size number box.

Note: The Size is based on the height of the uppercase 'A' character in the font. The recommended font size forms part of the name, for example Corinthian 15-35mm. See “Font Size” on page 362.

Range

To choose a size range, adjust the number in the Range \pm box, increasing the number to give a larger size range.

Note: For example, if the search range is 10-20mm, then fonts with ranges 5-15mm, 15-25mm, 12-16mm and 5-50mm will be visible, but fonts with ranges 3-8mm & 30-60mm will not. An imported embroidery font within this range will also be found.

About Fonts

Font means lettering style. In mySewnet™ Embroidery there are over 200 fonts, in 18 themed font categories. The currently selected font is previewed in the Font

section of the Lettering window. While mySewnet™ Embroidery remains open, the most recently used font is remembered.

To Select a Font

- Click font sample in the in the Letter window and scroll up or down the Font Viewer to select a font.

The category called My Fonts is the default location for fonts you create with the QuickFont.

Font Category

When a font category is selected, the font preview shows the first font in that category. There are 18 themed font categories:

Appliqué	Fonts for use with appliqué fabrics.
Children	Child-themed and "cute" fonts such as fonts similar to children's writing and animal fonts.
Display	Decorative fonts using specialty and pattern fills, often used in large sizes.
Effects	Fonts using special thread colors and needles such as needle felting, twin needle and wing needle.
Elegant	Stylish fonts with a heritage feeling, such as gothic and illuminated alphabets.
Floral	Fonts with leaves and flowers decorating the letters.
Foam	Fonts for use with puffy foam for a raised 3D effect.
Fun	Informal fonts, such as athletic or party fonts.
Future	Informal fonts with a hi-tech theme.
Modern	Fonts with 'clean' designs in modern styles.
Monogram	These fonts have most characters of equal width, designed for use in monograms. They are all uppercase only.
My Fonts	My Fonts is the default category for fonts you create.
National	Fonts associated with particular cultures, or alternative alphabets such as Greek and Hebrew.
Nearest Point	Nearest point fonts use special logic to determine the best way to join characters together. There are four versions of each character to enable the special joining method. Nearest Point fonts are ideally used with Running Stitch connection.
Retro	Classic Art Nouveau and Art Deco style fonts.
Scary	Informal fonts with a spooky or horror theme.
Script	Script fonts have a special joining method where all adjacent lowercase characters are directly joined together and are not affected by the Gap setting. This is used to give an appearance of handwriting in different styles.
Traditional	Old-fashioned fonts.
Wild West	Informal fonts with a cowboy theme.

Font Name

Font names include information in addition to the name of the lettering style. All font names include the recommended size range, and other information is often included.

Font Type

2C	The font uses two colors (also 3C for colors, etc.)
LC	Lowercase only font
NP	Nearest Point font
UC	Uppercase only font

Recommended Font Size

A recommended font size is included in the name. For instance, 25-120mm indicates the font is recommended for use at sizes from 25mm to 120mm.

SuperFonts

For SuperFonts provided in different stitch type variations, a stitch type abbreviation is also present at the end of the name, for example SF for Spiral Fill.

CF	Contour Fill
MF	Motif Fill
MW	MultiWave Fill
QS	QuiltStipple Fill
RF	Radial Fill
SF	Spiral Fill
SH	Shape Fill
XH	Crosshatch Fill
CH	Curved Crosshatch Fill
ML	Motif Line

Examples

Revue 2C UC 25-120mm SF in the Display Category: this font uses two colors (2C), is uppercase only, has a recommended size range of 25mm to 120mm, and uses Spiral Fill.

Antonia NP 05-10mm in the Nearest Point Category: this font is a Nearest Point font and has a recommended size range of 5mm to 10mm.

Font Size

Font size can be set from 3mm to 200mm. The size is based on the height of the uppercase 'A' character in the font. All other characters are sized relative to the height of 'A'. Fonts are initially set at the minimum recommended size for the font.

The recommended font size forms part of the name. For instance, Corinthian 15-35mm should be used with Size set from 15mm to 35mm.

In the National fonts using alternative alphabets, the character in the 'A' is used as the basis for sizing the characters.

If you set a satin font to a very large size, use Satin Properties to choose a pattern which will prevent loose stitching that may catch and pull easily. See “Satin Column” on page 494.

Once lettering has been converted to an embroidery it can only be scaled and resized in the same way as any other embroidery. If further adjustments are required, place the text again as new lettering.

To Set a Font Size

- In the Lettering window, click the Size up and down arrows or enter a number to change the font size.
- When lettering has been placed in the work area, you can resize it using Letter Properties. See “Changing Letter Properties” on page 398.
- In the work area, with some Lettering Shapes you can use the green handles on the selection box to resize the lettering. See “Using Block Lettering” on page 380.

Height and Width

Adjust height and width separately, to change the lettering proportions. For instance, you can make characters taller without increasing their width.

Height and width can be set from 25% to 400% of the original size, in steps of 1%.

Changing the Height and Width

- Enter a number in the height or width number box.
- Use the arrows to increase or decrease the height or width.

Gap and Kerning

Use Gap to change the spacing between characters in a line of lettering. A negative value brings the letters closer together and a positive value moves them farther apart. Gap can be set from -99 to +99. The settings stay the same until you change them or mySewnet™ Embroidery is closed.

Lowercase characters in Script fonts are not affected by the Gap setting.

Note: Increasing the Gap setting is recommended for Perspective lettering.

Adjusting Spacing Between Letters in a Line

- Enter a number in the Gap number box.
- Use the arrows to increase or decrease the Gap.

Automatic Kerning

Characters are spaced by automatic kerning according to the way that adjacent pairs of characters fit together. For example, the letters 'AV' need less space between them than 'AB' because of the shape of the characters. The Gap setting increases or decreases the spacing set by automatic kerning.

Script fonts have a special joining method where all adjacent lowercase characters are directly joined together and are not affected by the Gap setting.

The Gap is based on the width of the A character. A Gap of 1.0 is equal to 6% of the width of the A character.

To set the spacing between specific letters, set the letters to Individual in the Lettering window. See “Individual Letter Monogram” on page 394.

Connection

Use connection to select how the characters are joined together.

Trim: Insert a movement stitch (which will be trimmed if your embroidery machine has this feature) before and after each character in the lettering.

Running Stitch: Join the letters with small stitches. Use Running Stitch connection for small lettering with Nearest Point fonts.

Stitch Type

Use Stitch Type to alter the appearance of the stitching used in the lettering.

Note: If the Stitch Type area is dimmed, this means that the font was designed with properties that cannot be edited. This is usually because the properties vary within the font. For instance, different letters may use different fill patterns.

Note: To see the properties that can be edited in each font, refer to the mySewnet™ Fonts Guide in the Sample Guides folder.

To change the Stitch Type

- Choose a stitch type from the pop-up menu, then click the button with the ellipsis (three dots) to open the properties dialog for the stitch type. See “Choosing Stitch Properties” on page 462.

ColorSort

Use ColorSort to create lettering with the minimum number of color blocks. See “Lettering Color and ColorSort” on page 399.

- Select (check) ColorSort to use the minimum number of color blocks.

About Lettering

Text for lettering is entered in the Letters text box. This text will remain until you enter new text or close mySewnet™ Embroidery.

Note: If Check Spelling While Typing is selected, unrecognized words are underlined in red. If Correct Spelling Automatically is selected, suggested replacements are shown for unrecognized words.

To Enter Text for Lettering

- Enter text in the Letters text box.
- To start a new line of text, or break an existing line in two, use Option–Return (hold the Option key, then press Return). Use the arrow keys to move around the lines of text.

Note: Some Lettering Shapes (Circle Clockwise, Circle Counter-Clockwise, Fit to Straight Line and Fit to Wavy Line) can only use one line of text. Additional lines of text are combined with the first line for those Lettering Shapes. Full Circle only uses two lines of text. Any additional lines of text are combined with the second line.

- To change the text for lettering that has already been placed, select the lettering then Control–click within the lettering and the Letter Properties dialog appears. Letter Properties is not available after lettering has been fixed as embroidery. See “Changing Letter Properties” on page 398.

In an uppercase (UC) font any lowercase letters entered appear as uppercase, and in a lowercase (LC) font uppercase letters appear as lowercase.

If you enter special characters that are not available in a font, they do not appear on the work area when you apply the lettering.

Spelling Checker

The spelling checker underlines unrecognized words in red. You can select alternatives from the context menu.

Check Your Spelling

- 1 Control–click in the Letters text box and a context menu appears.
- 2 In the context menu choose Spelling and Grammar > Check Spelling While Typing.
- 3 Enter the words "Roses are red, viles are blue" in the Letters text box. The word "viles" is underlined in red.
- 4 Control–click to select the word. A context menu appears, with suggested alternatives listed at the top.
- 5 Choose the word "violets" from the context menu. The word is replaced in the Letters text box.
You can also use Learn Spelling to add words to the dictionary, for example your name, or use Ignore Spelling to ignore the suggestion.
- 6 Alternatively, choose Correct Spelling Automatically to see suggested replacements for unrecognized words.

Emoji and Symbols

Use Emoji & Symbols to add emoji (smileys), symbols and the extra characters used in many languages, for example ß, that are not present on your keyboard.

- Choose Edit > Emoji & Symbols (^⌘Space).

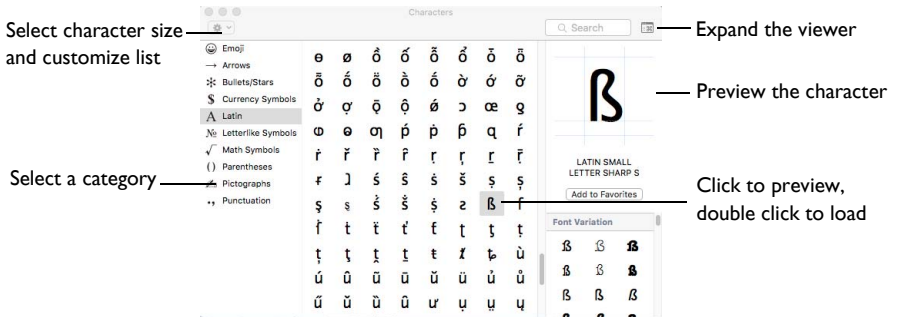

Add a Special Character to Your Text

- 1 Choose Edit > Emoji & Symbols.
- 2 Expand the viewer.
- 3 In the Characters Viewer, select a character category, e.g. Latin.
- 4 Click the desired character to select it. The character is previewed.
- 5 Double-click on the character to place it in the Letters text box.
- 6 Click Apply to place the lettering in the work area.



Note: See the Reference Guide for a list of the available characters.

Alternative Alphabets

To enter characters in other alphabets from the National font category, such as Greek and Hebrew, refer to the Character Sets section for the keys used. The Character Sets section shows the key to press to obtain the desired character. See “Character Sets” on page 559.

Letter Options

Use the Letter Options dialog to choose the alignment and line spacing when creating lettering.

All options stay the same until you change them, or close mySewnet™ Embroidery.

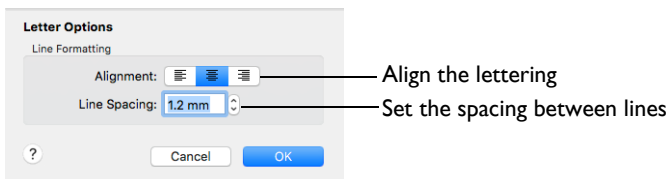

To change lettering after you have clicked Apply, use the Letter Properties dialog. See “Letter Properties” on page 396.

Line Formatting

Control how multiple lines of text are arranged relative to each other.

Alignment

Use the Alignment buttons to select left, center or right alignment. Text is initially centered.

Note: The Alignment setting does not affect circular lettering shapes.

Line Spacing

Use Line Spacing to change the distance between multiple lines of text.

Line Spacing can be adjusted from 1.0 to 5.0. The initial spacing is 1.2 for each new block of lettering.

Note: Line Spacing is based on the height of the A character. Spacing of 1.0 is equal to the height of the A character, plus 6%. If you have lower case lettering with descenders (the tails below the baseline on the g, p, q and y characters), you may wish to increase the Spacing, for example to 1.5.

Lettering Shapes

There are three categories of lettering shapes: Block, Line and Vertical Block.

- **Block**
Starting from a template, mould the block of letters to the desired shape. See “Block” on page 370.
- **Line**
Place letters along a straight, curved or wavy line. See “Line” on page 367.
- **Vertical Block**
Place lettering in a straight vertical line. See “Vertical Block” on page 370.

Using Lettering Shapes

If you have used the Lettering window previously in that session of mySewnet™ Embroidery, the last setting is remembered. You can adjust lettering with the handles (green squares) until it is fixed as embroidery, for example when you ColorSort it.

Note: Some Lettering Shapes (Circle Clockwise, Circle Counter-Clockwise, Fit to Straight Line and Fit to Wavy Line) can only use one line of text. Additional lines of text are combined with the first line for those Lettering Shapes. Full Circle only uses two lines of text. Any additional lines of text are combined with the second line.

Reverse: When the Reverse checkbox is selected, the lettering is mirrored. Reverse is available for all lettering shapes.

Note: Monograms created with the ExpressMonogram Assistant have light green handles; select Properties from the Context menu to adjust the Monogram settings. See “ExpressMonogram Assistant” on page 333.

Line

Place letters along a straight, curved or wavy line. Use the handles to adjust the position of the letters and the shape of the line.

- You cannot resize these lettering shapes with the handles.
Note: Control-click to open the Letter Properties dialog to resize the lettering. See “Changing Letter Properties” on page 398.
- Flip handles are not available. You can mirror after fixing the lettering as stitches.
- These lettering shapes can only use one line of text, or two for Full Circle. Additional lines are combined with the first line, or the second line for Full Circle.

Circle Shapes

Place characters along a curved line. Circle lettering shapes always use Center alignment.

- Rotate handles are not available for the Circle lettering shapes. To rotate, fix the lettering as stitches first.

Circle
Clockwise

Use Circle Clockwise  to place lettering clockwise around a circle.

Drag the square green handle to adjust the radius of the circle and the position of the lettering. Multiple lines of text are placed in the same line. Hold down Shift, then drag the handle to move the lettering around the circle without changing the size of the circle.

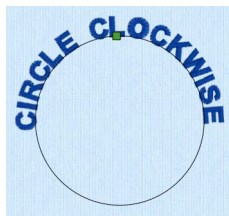

Circle Counter-
Clockwise

Use Circle Counter-Clockwise  to place lettering counter-clockwise around a circle.

Drag the square green handle to adjust the radius of the circle and the position of the lettering. Multiple lines of text are placed in the same line. Hold down Shift, then drag the handle to move the lettering around the circle without changing the size of the circle.



Full Circle Use Full Circle  to place two sections of text on opposite sides of a circle. When entering characters in the Letters text box, enter Option-Return to make a new line where you want to split the text. When the lettering is initially placed, the text on the first line is at the top of the circle and the text on the second line is at the bottom of the circle. If more than two lines of text are entered, Full Circle places all extra lines in the second line.

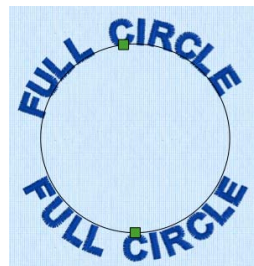

There are two square green handles. Drag either handle to adjust the radius of the circle. Hold down Shift, then drag either handle to move the attached lettering around the circle without changing the size of the circle.

Using Circular Lettering Shapes

The handles for circular lettering shapes adjust the positioning of the lettering, not the size.

- 1 Enter a short line of text in the Lettering window. See “Create Lettering” on page 356.
- 2 In the Lettering Shape area, click Circle Clockwise.
- 3 Click Apply. The lettering appears in a line over the top of a circle.
- 4 Drag the square green handle at the top of the circle of lettering downwards. The pointer changes to the circle size pointer .

The circle becomes smaller, but the size of the letters is unaffected.

- 5 Undo your change. The circle returns to its original size.
- 6 Hold down the Shift key and drag the square green handle at the top of the circle to the right of the circle. The line of lettering moves to the right side of the circle.

Note: You cannot resize circular lettering shapes with the handles. Use the Size and/or the height and width settings in Letter Properties. See “Changing Letter Properties” on page 398. Rotate and flip handles are not available. To rotate or mirror, use ColorSort to fix the lettering as embroidery first. The alignment setting does not affect circular lettering shapes.

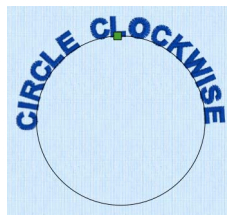

Fit to Straight and Wavy Lines

Use these line types to place lettering along a straight or wavy line.

Step: When the Step checkbox is selected, the letters can be rotated to any angle. Step is available for Fit to Straight Line and Fit to Wavy Line. See “Fit Lettering to a Line” on page 369.

Fit To Straight Line Use Fit To Straight Line  to place lettering along a line.

Drag the square green end handles to rotate the line to any angle and to extend the line. Drag the round green handle to move the text along the line.

The text may also be rotated independently of the position of the line. Select the Step option, then click Apply to create new lettering. There is an additional round green handle at the end of another line. Drag this handle to rotate the letters to any angle.

Note: You cannot resize

Fit To Straight Line lettering with the handles. Use the Size and/or the height and width settings in Letter Properties. Fit to Straight Line places multiple lines of text onto the same line.

Note: Flip handles are not available. To mirror, use ColorSort to fix the lettering as embroidery first.

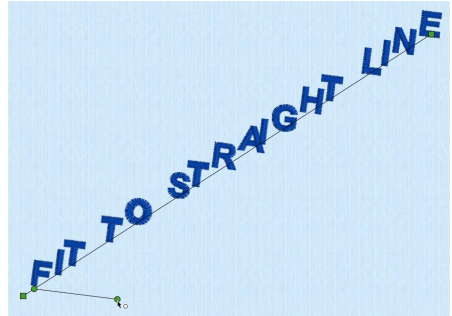

Fit To Wavy Line Use Fit To Wavy Line  to place lettering along a curved line.

Drag the square green handles to change the curve to any shape. Drag the round green handle to move the text along the line.

The text may also be rotated independently of the position of the line. Select the Step option, then click Apply to create new lettering. There is an additional round green handle at the end of another line. Drag this handle to rotate the letters to any angle.

Note: You cannot resize Fit To Wavy Line lettering with the handles. Use the Size and/or the Height and Width settings in Letter Properties. Fit to Wavy Line places multiple lines of text onto the same line.

Note: Flip handles are not available. To mirror, use ColorSort to fix the lettering as embroidery first.



Fit Lettering to a Line

- 1 Enter a short line of text in the Lettering window. See “Create Lettering” on page 356.
- 2 In the Lettering Shape area, click Fit to Straight Line.

- 3 Click Apply. The lettering appears along a sloping line.
- 4 Drag the square green handle on the right upwards. The angle on the line changes, but the size of the lettering, and the space between the letters does not.
- 5 Undo your change.
- 6 Drag the circular control along the line and to the right. The first letter of the lettering moves to the position of the circular control.
- 7 Delete the lettering.
- 8 In the Lettering window, select the checkbox labeled "Step".
- 9 Click Apply. There is now a green circular control at the end of a line below the lettering.
- 10 Drag the green control downwards. The letters in the line rotate.
- 11 Delete the lettering.
- 12 In the Lettering Shape area, click Fit to Wavy Line.
- 13 Click Apply. The lettering is now on a wavy line with four square green handles, and two green circular controls.
- 14 Adjust the controls to change the position of the letters.

Vertical Block

Use Vertical Block  to place lettering in a straight vertical line with an outline box that has four square green handles. Drag the handles to resize the lettering.

Note: Lettering is created with Center alignment by default. For Vertical Block, this changes the alignment of characters in each column of lettering.

Note: Hold the Shift key as you drag to resize proportionally, and hold the Option key to resize from the center.

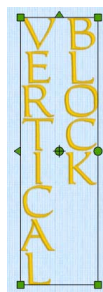

Block

There are 29 Block templates available. A block can be changed to any other kind of block using the handles and Handles menu options.

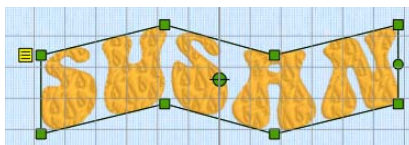

To change the settings for a Block

- Click the yellow handle on the selected block, and use the options in the Handles menu to change the Top and Bottom line types, and to set different Constraints.



Individual: When the Individual checkbox is selected, the letters can be moved and resized individually. Only one line of lettering can be made when Individual is selected. See "Individual Letter Monogram" on page 394.

Handles Menu

Use the Handles menu  to adjust the settings for the selected block of lettering.



Change Template Settings in the Block Menu

- 1 Open the Letter window .

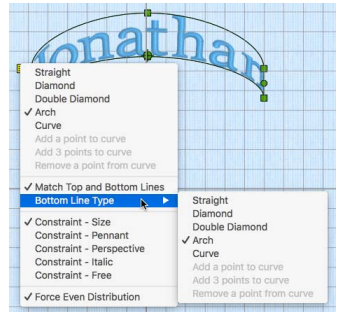
- 2 Enter the text "Jonathan" in the Letters text box. See "Using Block Lettering" on page 380.
 - 3 Click the current Lettering Shape, and in the pop-up menu, choose Arch Over , then click Apply to place the name.
- Note:* The top and bottom lines of the lettering use the Arch line type, with a single handle in the middle.
- 4 Drag the lettering to the top of the work area.
 - 5 Drag the two middle handles (top and bottom) upwards, to raise the height of the arch.
 - 6 Click the yellow Handles button  to open the handles menu.



- Note:* In the menu the line type is shown as Arch.
- 7 Deselect Match Top and Bottom Lines. This enables you to use a different line type for the top and bottom of the shape.
 - 8 Open the Handles menu  again, and then click to open the Bottom Line Type submenu.
- Note:* The line type for the bottom line is also Arch.
- 9 In the submenu, change the bottom line to Straight.
- Note:* The bottom of the lettering is now a straight line with a handle at each end.

- 10 Open the Handles menu  again, and change the top line to Diamond.
- Note:* The top line forms a point, instead of a curve. The Double Diamond option forms a straight line with two peaks.
- 11 Open the Handles menu  again, and change the top line to Curve.
- Note:* The top line now has a curve with two handles.

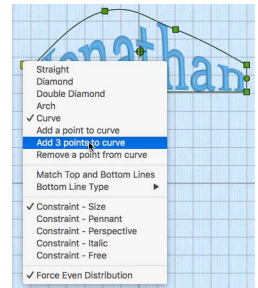

- 12 Move the two middle handles on the top line separately.
 - 13 Open the Handles menu  again, and choose Add 3 points to curve. Three more handles are added to the top of the block.
- Note:* The add and remove points options are only available when the line type is a Curve.
- 14 Adjust the top line as desired.

While you can adjust the top and bottom as desired, the sides are still parallel straight lines, and if you move the handle at the top of one side, the handle at the top of the other side moves with it. This is Constraint - Size.

Note: If you hold the Shift key while dragging, the proportions of the shape are locked. With Option key the shape is resized from the center.

- 15 In the Handles menu, choose Constraint - Pennant.
 - 16 Drag the handle at the top right upwards. The handle below it moves in the opposite direction.
- Note:* With a rectangular block, this would create a shape like a pennant. Hold down the Shift key to create a skewed rectangle effect.

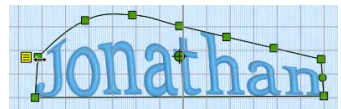



- 17 In the Handles menu, choose Constraint - Perspective.
 - 18 Drag the handle at the top right to the left. The lines on the side of the block now form a slope.
 - 19 In the Handles menu, choose Constraint - Free. You can now move any of the corner handles in any direction you like.
- Note:* You can only drag the middle handles in the curve up and down.

- 20 In the Handles menu, deselect Force Even Distribution.
- 21 Drag one of the middle handles on the curve sideways. The letters move with the handle. The functions in the Handles menu enable you to sculpt a block of lettering into almost any shape you like.

Top and Bottom Line Types

Choose a line type for the top and bottom of the block to set how the lettering is displayed.

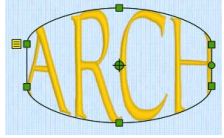
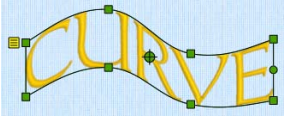
- | | | |
|----------------|---|--|
| Straight | Use Straight to create a lettering block with a straight line for the top and / or bottom, and with a handle at each end. |  |
| Diamond | Use Diamond to create a lettering block with a point at the top and / or bottom. Drag the central handle to change the angle of the slope. |  |
| Double Diamond | Use Double Diamond to create a lettering block with straight lines between the four handles at the top and / or bottom. Drag the central handles to change the angle of the straight lines. |  |
| Arch | Use Arch to create a lettering block with a curve at the top and / or bottom. Drag the central handle to change the angle of the curve. |  |
| Curve | Use Curve to create a lettering block with curved lines between the four handles at the top and / or bottom. Drag the central handles to change the curves between the handles. |  |
- Note:* You can add and remove extra points (handles) in a Curve.

Add and Remove Points to a Curve

- Use the Add and Remove points functions to change the number of points in a Curve.
 - Add a point to curve adds a single point to the right end of the selected curve.
 - Add 3 points to curve adds three points to the right end of the selected curve.
 - Remove a point from curve deletes a single point from the right end of the selected curve.

Note: The minimum number of points in a Curve is four.

Match Top and Bottom Lines

- Use Match Top and Bottom Lines to use the same line type for the top and bottom lines in a block.

Note: When Match Top and Bottom Lines is selected, the Bottom Line Type submenu is not available.

Constraints

Constraints affect how the corner handles on a block behave.

- Size** When Constraint - Size is used, the two corners adjacent to the corner that is dragged move the same distance, in the same direction. The corner diagonally opposite does not move. The handles on the straight or curved lines between the corners move in proportion. This preserves the shape of the block, while the size changes.

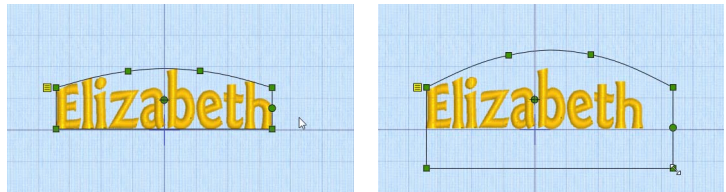

Note: If you hold the Shift key while dragging, the proportions of the shape are locked. With the Option key the shape is resized from the center.

- Pennant** When Constraint - Pennant is used, the corner above or below the corner that is dragged moves the same distance towards or away from the dragged corner vertically. The other two corners do not move. This forms a pennant shape.

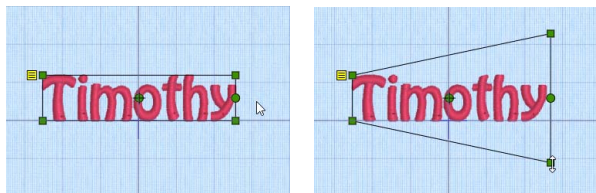

Note: Hold down the Shift key to give a vertical skew to the lettering.

- Perspective** When Constraint - Perspective is used, the corner to the right or left of the corner that is dragged moves the same distance towards or away from the dragged corner horizontally. The other two corners do not move. This gives a perspective effect.

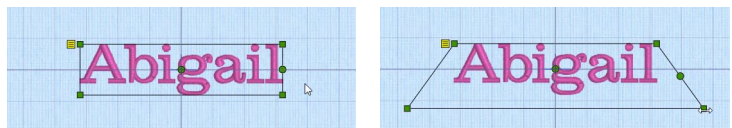

Note: If you hold the Shift key while dragging, the two handles move together as with Italic.

Italic When Constraint - Italic is used, the corner to the right or left of the corner that is dragged moves the same distance, in the same direction. The other two corners do not move. This gives an italic look to the lettering.

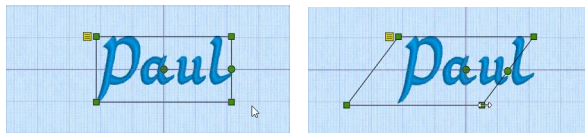

Note: If you hold the Shift key while dragging, the two handles move separately as with Perspective.

Free When Constraint - Free is used, the corner handles can be dragged in any direction.

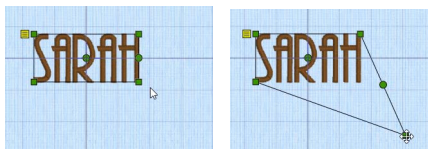

Note: If you hold the Shift key while dragging, the proportions of the shape are locked. With the Option key the shape is resized from the center.

Force Even Distribution

- Use Force Even Distribution to distribute the handles between the two corners evenly.

Note: Force Even Distribution affects both the top and bottom of the block.

Block Templates

There are 29 templates for use with lettering.

Horizontal Block

Use Horizontal Block  to place lettering in a straight line with an outline box that has four square green handles. Drag the handles to resize the lettering.



Note: Hold the Shift key as you drag to resize proportionally, and hold the Option key to resize from the center.

Template Settings: Straight, Straight; Constraint - Size, Force Even Distribution

Rounded

Use Rounded  to place lettering in an envelope with an outwardly curving top and base. There are six square green handles. Drag the handles to resize the lettering and the curvature of the arches.



Template Settings: Arch, Arch; Constraint - Size, Force Even Distribution

Double Arch Use Double Arch  to place lettering in an envelope with an inwardly curving top and base. There are six square green handles. Drag the handles to resize the lettering and the curvature of the arches.

Template Settings: Arch, Arch; Constraint - Size, Force Even Distribution

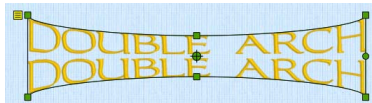

Diamond Use Diamond  to place lettering in a diamond envelope. There are six square green handles. Drag the handles to resize the lettering and the distance between vertical pairs of handles. Hold down Shift, then drag the handles to move the vertical pairs of handles while keeping the same distance between them.



When the Individual checkbox is selected, each letter is created in a diamond-shaped envelope and can be moved and resized individually.



Template Settings: Diamond, Diamond; Constraint - Pennant, Force Even Distribution

Italic Use Italic  to place lettering in an envelope that is slanted to the right. There are four square green handles. Drag the handles to resize the lettering. Hold down Shift, then drag the handles to the left or right to change the slant of the text.



When the Individual checkbox is selected, each letter is created in an italic envelope and can be moved and resized individually.

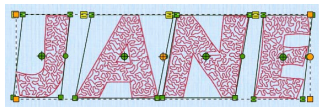

Template Settings: Straight, Straight; Constraint - Italic, Force Even Distribution

Freeform Use Freeform  to place lettering in a fully adjustable straight envelope. There will be 4 square green handles. Drag the handles to resize the lettering and change the shape as desired.





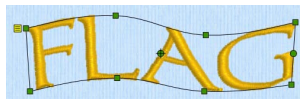

Template Settings: Straight, Straight; Constraint - Free

Flag Use Flag  to place lettering in a curving envelope. There will be eight square green handles. Drag the handles to resize the lettering and change the shape.



Template Settings: Curve, Reflect Top and Bottom Lines; Constraint - Perspective, Force Even Distribution

- Free Sculpt** Use Free Sculpt  to place lettering in a fully adjustable curved envelope. There will be 14 square green handles. Drag the handles to resize the lettering and change the shape as desired.
Template Settings: Curve, Curve; Constraint - Free
- Arch Over** Use Arch Over  to place lettering in an envelope with an outwardly curving top and an inwardly curving base. There are six square green handles. Drag the handles to resize the lettering and the curvature of the top and base.
Template Settings: Arch, Arch; Constraint - Size, Force Even Distribution
- Arch Under** Use Arch Under  to place lettering in an envelope with an inwardly curving top and an outwardly curving base. There are six square green handles. Drag the handles to resize the lettering and the curvature of the top and base.
Template Settings: Arch, Arch; Constraint - Size, Force Even Distribution
- Fan** Use Fan  to place lettering in an envelope with an outwardly curving top and an inwardly curving base. There will be six square green handles. Drag the handles to resize the lettering, and the angle and curvature of the top and base.
Template Settings: Arch, Reflect Top and Bottom Lines; Constraint - Perspective, Force Even Distribution
- Bowl** Use Bowl  to place lettering in an envelope with an inwardly curving top and an outwardly curving base. There will be six square green handles. Click and drag the handles to resize the lettering, and the angle and curvature of the top and base.
Template Settings: Arch, Reflect Top and Bottom Lines; Constraint - Perspective, Force Even Distribution

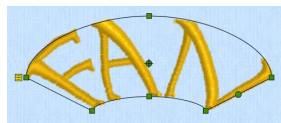
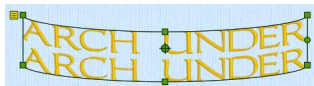
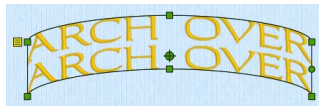
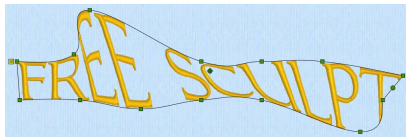

Pennant Right Use Pennant Right  to place lettering in an envelope that is larger on the right side. There are four square green handles. Drag the handles to change the size of each end of the pennant. Hold down Shift, then drag the handles to move one end of the pennant up or down. When the Individual checkbox is selected, each letter is created in a pennant-shaped envelope and can be moved and resized individually. Template Settings: Straight, Straight; Constraint - Pennant, Force Even Distribution



Pennant Left Use Pennant Left  to place lettering in an envelope that is larger on the left side. There are four square green handles. Drag the handles to change the size of each end of the pennant. Hold down Shift, then drag the handles to move one end of the pennant up or down. When the Individual checkbox is selected, each letter is created in a pennant-shaped envelope and can be moved and resized individually. Template Settings: Straight, Straight; Constraint - Pennant, Force Even Distribution

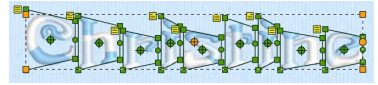

Perspective Use Perspective  to place lettering in an envelope that is narrower at the top. There are four square green handles. Drag the handles to resize the lettering and change the width of the top or bottom of the text. Hold down Shift, then drag the handles to the left or right to change the slant of the text. *Note: Increasing the Gap setting is recommended for Perspective lettering.* When the Individual checkbox is selected, each letter is created in a perspective-shaped envelope and can be moved and resized individually. Template Settings: Straight, Straight; Constraint - Perspective, Force Even Distribution



Bridge Convex Down Use Bridge Convex Down  to place lettering in an envelope with a flat top and an outwardly curving base. There are five square green handles. Drag the handles to resize the lettering and the curvature of the base. Template Settings: Straight, Arch; Constraint - Size, Force Even Distribution



Bridge Concave Down Use Bridge Concave Down  to place lettering in an envelope with a flat top and an inwardly curving base. There are five square green handles. Drag the handles to resize the lettering and the curvature of the base. Template Settings: Straight, Arch; Constraint - Size, Force Even Distribution



Bridge Convex Up Use Bridge Convex Up  to place lettering in an envelope with a flat base and an outwardly curving top. There are five square green handles. Drag the handles to resize the lettering and the curvature of the top. Template Settings: Arch, Straight; Constraint - Size, Force Even Distribution

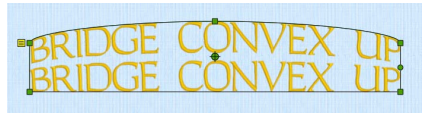







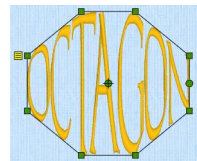



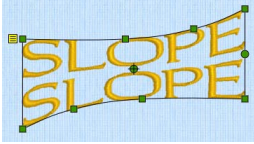

Bridge Concave Up Use Bridge Concave Up  to place lettering in an envelope with a flat base and an inwardly curving top. There are five square green handles. Drag the handles to resize the lettering and the curvature of the top. Template Settings: Arch, Straight; Constraint - Size, Force Even Distribution

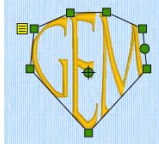

Octagon Use Octagon  to place lettering in a octagonal envelope. There will be eight square green handles. Click and drag the handles to resize the lettering and the distance between vertical pairs of handles. Template Settings: Double Diamond, Reflect Top and Bottom Lines; Constraint - Size, Force Even Distribution

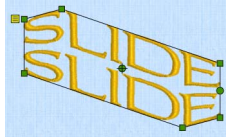

- Zigzag** Use Zigzag  to place lettering in an angled line envelope. There will be eight square green handles. Click and drag the handles to resize the lettering and the angle of the sides. Template Settings: Double Diamond, Reflect Top and Bottom Lines; Constraint - Italic 
- Chevron** Use Chevron  to place lettering in a peaked envelope. There will be six square green handles. Click and drag the handles to resize the lettering and the angle of the sides. Template Settings: Diamond, Reflect Top and Bottom Lines; Constraint - Perspective, Force Even Distribution 
- Slope** Use Slope  to place lettering in a curved sloping envelope. There will be eight square green handles. Click and drag the handles to resize the lettering and change the shape. Template Settings: Curve, Reflect Top and Bottom Lines; Constraint - Italic 
- Butte** Use Butte  to place lettering in a straight sided envelope with eight square green handles. Click and drag the handles to resize the lettering and the distance between the sides. Template Settings: Double Diamond, Reflect Top and Bottom Lines; Constraint - Perspective 
- Gem** Use Gem  to place lettering in an envelope with seven square green handles. Click and drag the handles to resize the lettering. Template Settings: Double Diamond, Diamond; Constraint - Perspective, Force Even Distribution 
- Slide** Use Slide  to place lettering in a sloping rectangular envelope. There will be six square green handles. Click and drag the handles to resize the lettering and the distance between vertical pairs of handles. Template Settings: Diamond, Reflect Top and Bottom Lines; Constraint - Italic 

Pentagon Use Pentagon  to place lettering in an envelope with a peaked top, a straight base, and sloping sides. There will be five square green handles. Click and drag the handles to resize the lettering and change the angle of the sides and top.

Template Settings: Diamond, Straight; Constraint - Size; Force Even Distribution

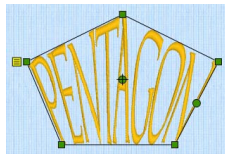

Ramp Use Ramp  to place lettering in an envelope with a curved top, a straight base, and sloping sides. There will be six square green handles. Click and drag the handles to resize the lettering and change the angle of the sides and top.

Template Settings: Curve, Straight; Constraint - Italic

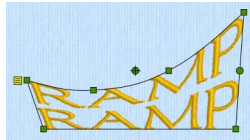

Rocket Use Rocket  to place lettering in an envelope with a peaked top and an arched base. There will be six square green handles. Click and drag the handles to resize and reshape the lettering.

Template Settings: Diamond, Arch; Constraint - Perspective



Using Block Lettering

- 1 Enter the text "Backwards" in the Letter window. See "Create Lettering" on page 356.
- 2 In the Lettering Shape area, click the Lettering Shape button and choose Horizontal Block.
- 3 Click Apply. The lettering appears in the work area.
- 4 Drag the text a short distance to the right. A four-arrow pointer appears as you drag.
- 5 Place the pointer over one of the square green handles at the corners of the lettering. The Adjust/resize pointer  appears.
- 6 Use the handles to adjust the size and shape of the lettering. Hold the Shift key to keep the proportions. Hold the Option key to resize from the center.
- 7 Control-click and choose Delete to remove the lettering from the work area.
- 8 In the Lettering window, select the checkbox labeled "Reverse".
- 9 Click Apply. The lettering appears on the work area with the text mirrored.
- 10 Delete the lettering and deselect Reverse.
- 11 In the Lettering window, select the checkbox labeled "Individual", and change the text in the box to "SINGLE".
- 12 Click Apply. The lettering appears on the work area with each letter in its own selection box.

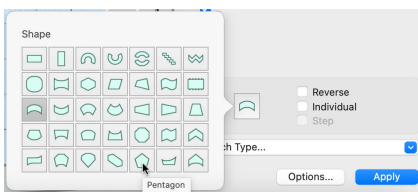

- 13 To use another lettering shape, select a different Lettering Shape button and click Apply again.

Setting Letter Options

- 1 Enter some text in the Lettering window. See “Create Lettering” on page 356.
- 2 Click the arrows for height and width to change the proportions of the lettering from 25% to 400%. Alternatively, enter a size in the number box.
- 3 Adjust Gap to change the spacing between the letters. Click the arrows, or enter a value. Negative values move letters closer together, and positive values move them farther apart.
- 4 Select Trim or Running Stitch as the connection method.
Note: Use Running Stitch connection for small single-color lettering with Nearest Point fonts.
- 5 Select a Lettering Shape for your lettering. See “Using Block Lettering” on page 380.
- 6 Click Options. The Letter Options dialog appears.
- 7 Select the alignment of the line of lettering. Click Left, Center or Right, as desired.
- 8 Click the arrows for Line Spacing to set the distance between multiple lines of text. Alternatively, enter a size in the number box.
- 9 Click OK to close the Letter Options dialog.
- 10 Choose a line or fill type from the Stitch Type pop-up menu with the ellipsis (3 dots). The properties dialog for the stitch type opens. See “Choosing Stitch Properties” on page 462.
- 11 Change the stitch properties for the lettering in the properties dialog, for example the density, pattern, angle or stitch length. Click OK to close the dialog.
- 12 In the Lettering window, click Apply to view your lettering.

To change the lettering, use Control-click to open the Letter Properties dialog or a stitch properties dialog (see “Changing Letter Properties” on page 398). To change settings for new pieces of lettering, open the Letter Options dialog again, and alter your settings. Then click Apply in the Lettering window again.

Font Manager

Use Font Manager to arrange, rename, duplicate and delete user fonts.

Note: Font Manager only displays user created fonts.

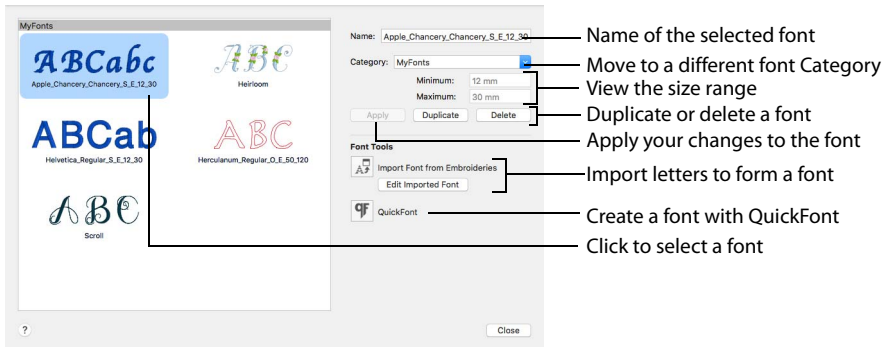

Font Preview

The selected font is previewed, showing its type, name, category and size range.

Name

Use the Name text box to change the name of the selected user font.

To rename a font

- Edit the font name in the text box, then click Apply to save your changes.

Note: Remember to preserve the size range information when changing the name. Changing the name does not change the size range.

Category

Select a different Category for the font, or enter the name for a new font Category.

Change the font Category

- Select a Category from the pop-up menu, and click Apply to confirm the change. The font moves to its new Category.

Note: If the selected Category already contains a font with the same name, an error message is displayed: "A font already exists in this category with this name." Rename the font, or select another font.

Size

View the Minimum and Maximum recommended size for the font.



Note: This is the size range used by Font Search.

Duplicate

Use Duplicate to create a copy of the selected user font.

The copy is placed in the same Category as the original font, using the same name suffixed with "Copy of ".

Make a Copy of a Personal Font



- 1 Open the Letter window .
- 2 Click to launch Font Manager .
- 3 Click the font you want to copy in Font Manager.
- 4 Click the Duplicate button. The font name changes to the original name with "Copy of " in front.
Your original font and its copy are now in the font category, with your new font selected.
- 5 In Name, change the text to give your copied font a new name.
Note: Take care not to remove the part of the name indicating the font size.
- 6 Click Apply to save the copied font under the new name.
- 7 If desired, use the Category pop-up menu to place the font in a different Category, then click Apply again to confirm this change.
Note: Alternatively, enter the name for a new font Category, then move the font.

Delete

Use Delete to remove the selected user font from your computer. You cannot delete system fonts using Delete.

Note: If you delete a font that you used in an embroidery, when you open the embroidery again the lettering will have been fixed as an embroidery. You will no longer be able to edit the lettering.

Delete a Font

- Note:* Make a backup of your fonts before using Delete, as you cannot Undo font removal.
- 1 Open the Letter window .
 - 2 Click to launch Font Manager .
 - Note:* You can only Delete a User generated (personal) font.
 - 3 Click to select the font you want to delete in Font Manager.
 - 4 Click the Delete button. A message is displayed "This will remove your font and cannot be undone. Do you want to continue?".
 - 5 Click Yes to remove the font from your computer.
Note: If you deleted the wrong font, copy it back in from your backup.

Font Tools

Import Font from Embroideries

Use Import Font from Embroideries  to import individual embroidered letters to create a font in the Import Font from Embroideries dialog. Use the Edit Imported Font button to make changes to an imported font. See "Import Font from Embroideries" on page 385.

QuickFont

Use QuickFont  to create new fonts for mySewnet™ Embroidery automatically from most TrueType® or OpenType® fonts on your computer in mySewnet™ QuickFont. See “QuickFont” on page 401.

Import Font from Embroideries

Use Import Font From Embroideries  to import individual embroidered letters to create a font. Browse to individual letters, or drag them from the Finder.

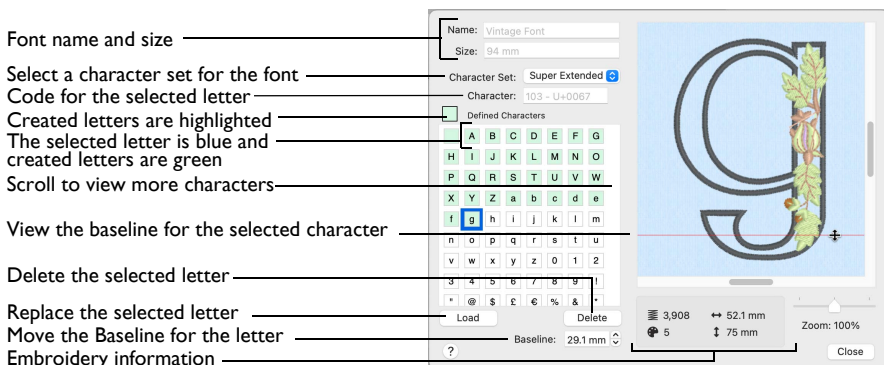

Note: For best results, remove any stray stitches in mySewnet™ Stitch Editor before importing the letters.

As the imported letters are stitch files, rather than fully adjustable design files, they work best at their original size, with the minimum of reshaping.

Note: Imported fonts work best with the Line, Vertical Block and Horizontal Block lettering shapes.

Name

The name that the font was given in the Select a Name dialog is displayed.

Note: This name is unique. An error message is displayed if an existing name is used.

Size

The size of the font. This is taken from the size of the Upper Case 'A', which is the first letter in the font to be created.

Character Set

Choose a character set for the font. The available options are: Extended, Super Extended, Latin 1, Western 1, Western 2, Western 3, Western 4, Cyrillic 1, Cyrillic 2, Cyrillic 3, Hiragana 1, Hiragana2, Greek 1 and Hebrew 1. The default character set is Extended.

Note: For more information on character sets, see “Select Font” on page 404.

Character

The ASCII character code for the selected letter is given.

Defined Characters

The letters that have already been created are highlighted in green, and the selected letter is highlighted in blue. Scroll down to view more letters (for example Lower Case letters).

- Click to select a letter to create, replace or delete in the letter panel.
- Use Page Up and Page Down on the keyboard to move between the letters.

Load

Use Load to replace the current character with a different embroidery. For example, reload if an incorrect character was selected, or to reload the embroidery at its original settings.

- Click Load to reload the selected character.

Delete

Use Delete if a character was created in error, for example if a Lower Case letter was added to an Upper Case font.

- Click Delete to remove the selected character from the letter panel.





Baseline

Adjust the Baseline for descender characters like Lower Case g, p, and y, or where a decoration on the character descends below the natural Baseline for the character.

Note: The dashed top red line indicates the position of the top of the Upper Case A. Use this when adjusting the position of letters and punctuation symbols.

- Enter a number for the Baseline of the selected character.
- Use the up and down arrows to adjust the positioning of the character on the Baseline, or drag the solid red Baseline to position the character.

Design Information

The Design Information shows the stitch count , dimensions (Width  and Height ) ,and number of colors  for the character embroidery.

Zoom Bar

Use the Zoom Bar at the bottom of the screen to zoom in or out from the center of the embroidered letter.

- Use the slider to zoom in or out from the selected character.

Select a Name



Use the Select a Name dialog to give your imported font a name.

Note: An error message is displayed if the name has already been used.

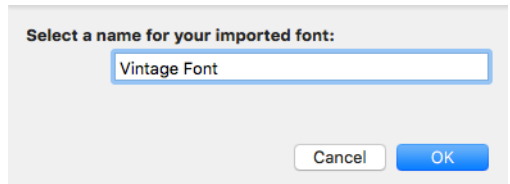
Name the font, then click OK to select the letter 'A' for the font in the Open dialog.



Create a Font from Embroidered Letters

- 1 Place your embroidered letters in a folder on your computer.
Note: The font illustrated here is Vintage Floral Monogram from the mySewnet™ Library.
- 2 Open the Letter window .
- 3 Click Font Manager . The Font Manager dialog opens.
- 4 Click Import Font from Embroideries . A dialog opens for you to name your font.
- 5 Enter a name for your font, and click OK.
The font naming dialog closes and an Open dialog appears.
- 6 In the Open dialog, browse to the folder with your embroidered letters.
Note: The Icon View option is useful when selecting letters.

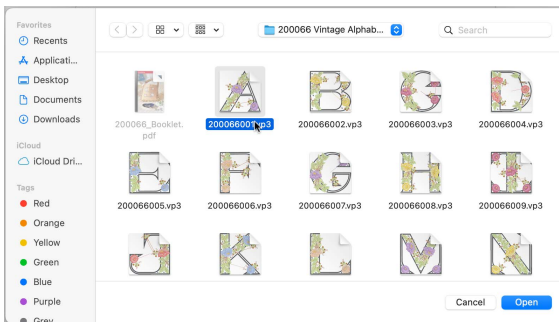
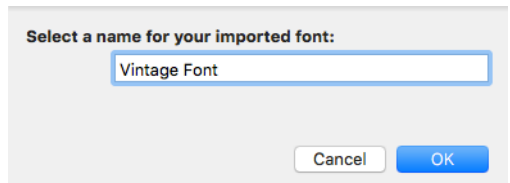

- 7 Select the Upper Case letter 'A', then click Open. The Import Font from Embroideries dialog opens with the letter 'A' selected.

Note: There is a red Baseline under the letter 'A'. The Baseline sets where the letter is placed along the line relative to the other letters in the font.

Note: When using Import Font from Embroideries to create a font from individual embroideries, the Upper Case 'A' is always created first. The size of the letters in the font is taken from the letter 'A'.

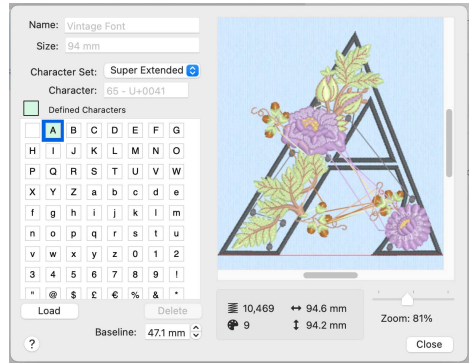

- 8 In the Letter panel on the left, click the letter 'B'. The Open dialog opens for you to load the letter 'B'.
- 9 Click to select the letter 'B', then click Open to load it in the Import Font from Embroideries dialog.

Note: There is a red dashed line above the 'B'. This line indicates the position of the top of the letter 'A'.

- 10 Click to select the letter 'C' and load it.
- 11 Without closing Import Font from Embroideries, open a Finder window and browse to the letters for your font.
- 12 In the Finder window, select the letter 'D' and drag it to tile D in the Import Font from Embroideries dialog.

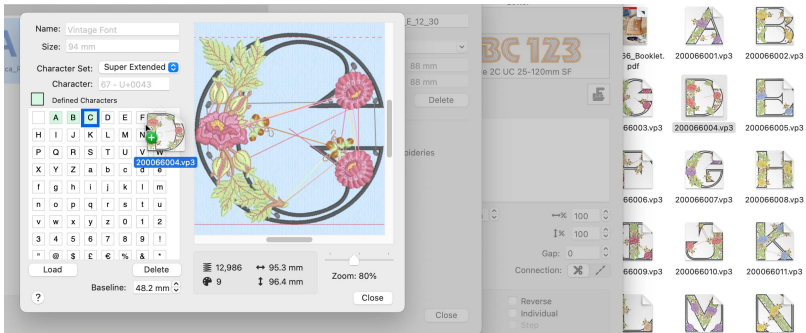

- 13 Select the letter 'G' and drag it to the E tile. The letter 'E' is highlighted, but the letter 'G' is in the preview.
 - 14 Drag the letter 'E' to place it in the correct position.
- Note:* You can also use Load and Delete to replace and remove unwanted letters.

15 Select and drag to load the other upper case letters in your alphabet, then load the lower case letters up to the letter 'f'.

16 Drag the small 'g' onto its tile.

17 The solid red line across the preview is the Baseline for the selected letter. Drag the Baseline upwards so that the body of the 'g' rests on it, and the tail hangs below. The line moves up across the letter.

You can also use the up and down arrows by the Baseline number box to adjust the Baseline, or enter a number.

Note: The Baseline sets where the letter will be placed along the line relative to the other letters in the font.

18 Scroll down the Defined Characters display to view more letters.

19 Drag the apostrophe onto its tile.
Note: You can use the comma for an apostrophe.

20 Drag the Baseline downwards to place the apostrophe just below the dashed line at the top.

Note: You may need to zoom out using the slider to adjust the position of the lines.

21 Load the remaining embroideries for the font, and adjust the Baseline for the letters.

22 Click Close twice when you have finished, to close this and the Font Manager dialog.
Note: When you need to take a break, click Close to save the font, and Font Manager, then browse to it in the My Fonts Category to load it again with the Edit Imported Font button.

Adjust your Imported Font

23 Select your new font in the Letter window.

24 In the Letters text box, enter a series of letters to view their position relative to the Baseline, for example "abcdefghijklm".

25 In the Shape pop-up menu, choose Fit to Straight Line , then click Apply.

26 If needed, adjust the hoop size and orientation so that your lettering will fit.

Note: For larger letters, use a custom hoop size.

27 Drag the green handle on the right up or down so that the lettering lies horizontally along one of the grid lines.

28 Drag the lettering to the bottom of the hoop.

29 Open the Font Manager .

Note: Your lettering should be visible below the Font Manager.

30 Ensure that your imported font is selected, and click Edit Imported Font.

31 In the Import Font dialog, select a letter that needs adjusting. In this example I will adjust 'f'.

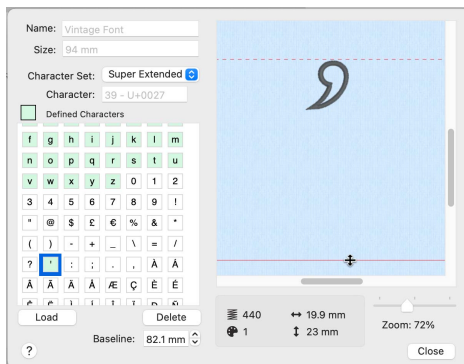
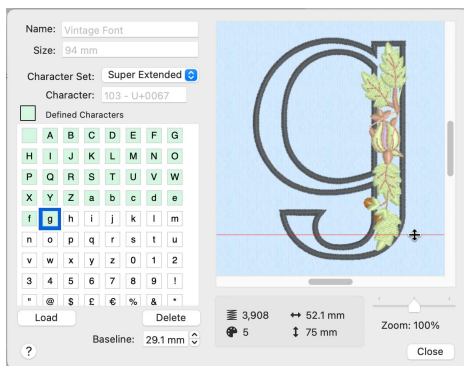

- 32 Drag the solid red Baseline below the 'f' upwards so that the bottom of the 'f' will be below the Baseline.

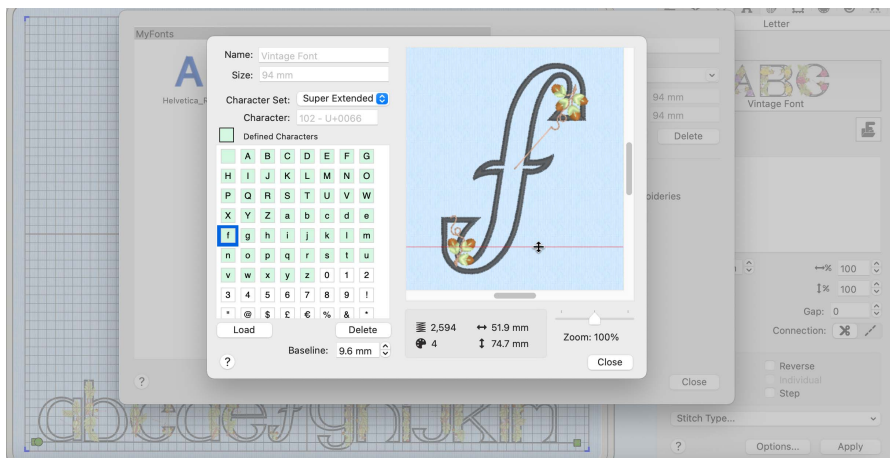

- 33 Release the mouse. The letter 'f' in the text below the dialog moves downwards.
34 Adjust the Baseline again so that the letter 'f' is aligned correctly with the other letters.
35 Select the small letter 'j'.
Note: Either click on the 'j', or use the Page Up and Page Down keys on the keyboard to move through the letters in the dialog.
36 Adjust the 'j', then adjust any other letters in that line.

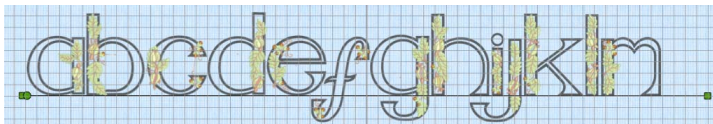

- 37 Adjust the other letters in your alphabet.
If you want to start again with a particular letter, click Load and reload the embroidery.
Note: Many Upper Case fonts will need little Baseline adjustment. Lower Case letters are likely to need more adjustment, particularly letters like p, g, and y with descenders.
38 When you have adjusted all of your letters, click Close to save your font, and then in Font Manager click Close again.
39 Use your new font in the Letter tab.
Note: To fine tune the placing of your letters in the work area, use the Individual option.











Imported fonts work best with the Line, Vertical Block and Horizontal Block lettering shapes.

As the imported letters are stitch files, rather than fully adjustable design files, they work best at or near to their original size, with the minimum of reshaping.

Lettering Examples

Use lettering to enhance an embroidery, or create a monogram.

Full Circle Lettering: I Love the Sunshine

- 1 If required, choose File > New.
- 2 Click Hoop  and in the Universal Hoop Groups select 260mm x 200mm - Universal Large Hoop 3.
- 3 Set Orientation to Rotated and click OK.
- 4 Choose mySewnet™ Embroidery > Preferences or , and ensure that the Grid size is set to 10mm.
- 5 Choose File > Insert. See “Insert” on page 25.
- 6 Browse to mySewnet/Samples/Embroidery/Stitch.
- 7 Scroll down to "Sunshine Applique Large.vp4" and select it.
- 8 Click Open to load the embroidery into the work area.
The embroidery has white or blue handles on its selection box, depending on the Resize  mode.
- 9 In the Letter window  of the Control Panel , click the displayed font, and scroll down the font viewer until you see the Traditional font category.
- 10 Select the font Georgia 20-40mm and click OK.
- 11 Deselect (uncheck) ColorSort.
Note: Each letter will have its own color block.
- 12 Enter the words "I love the" in the Letters text box.
- 13 Press Option-Return to start a new line.
- 14 Enter the word "Sunshine".
- 15 In the Lettering Shape pop-up menu, click Full Circle.
- 16 Click Apply. The lettering appears in the center of the work area surrounding the embroidery. Its handles are green.
Note: The green handles indicate that the lettering has not yet been fixed as an embroidery.
Note: If the lettering does not surround the embroidery, the embroidery was not selected. Click Actions  > Undo or  to undo the lettering, click to select the embroidery, then click Apply again.
- 17 Drag the square green handle at the top of the circle of lettering downwards half a grid square.
The circle becomes smaller, but the size of the letters is unaffected.
- 18 Open the Design window  of the Control Panel .
Each letter has a separate color block in the Color Select area.
- 19 Move the arrow pointer over the 9th color block and pause for a moment. The letter 'S' is highlighted, and a popup description of the thread is displayed.
- 20 Click the color block. The Color Selection dialog appears.
- 21 Select 'All Thread Ranges'.
- 22 Choose Solar Active Ultra Violet 40 from the pop-up menu.

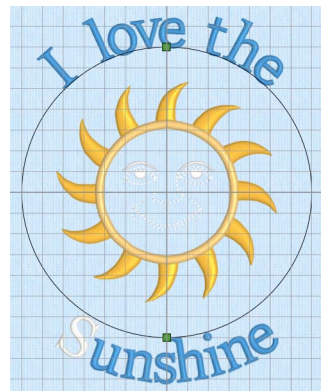
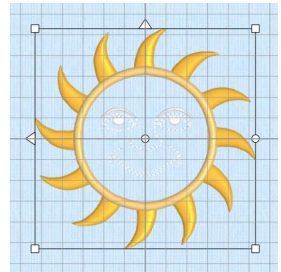

23 Select thread color 0002 (White/Orange). Click OK to change the color. The S in Sunshine is now white.

24 Change each of the other color blocks in the word 'Sunshine' to Solar Active Ultra Violet 40, thread color 0002 (White/Orange).

25 Control-click the lettering, and choose Fix as Stitches in the Context menu. The lettering now has white or blue handles (depending on the resize  setting). You can no longer adjust other stitch properties.

26 Click Design > ColorSort. There are now only two thread colors.

27 Click the blue (number 1) in the Color Select and in the Color Selection dialog ensure that All Thread Ranges is selected, then choose Solar Active Ultra Violet 40 from the pop-up menu.

28 Select thread color 0001 (White/Yellow) and click OK to change the color.

29 In the toolbar, click Select All Visible , then click Design > Center in Hoop. Both the sun embroidery and the lettering are centered in the hoop.

30 Click Life View .

31 Click Solar Reactive . The sun's face and the lettering change from white to yellow and orange. *Note: Solar Reactive simulates the sun shining on the photochromic threads in the design. The threads change shade to show the colors they will become in sunlight.*

32 Click File > Save and save the embroidery as 'I love the Sunshine'. This will save the sun and lettering separately within this multipart embroidery, making further adjustment easier.

33 Click File > Export to export the sunshine embroidery.

34 In the Export dialog, ensure that .vp4 is selected and click Continue.

35 In the Saving as dialog, browse to mySewnet/My Designs, and save the embroidery as 'I love the Sunshine' (a .vp4 file extension and the word Exported are added automatically). *Note: When exported, the embroidery is automatically combined and ColorSorted if those options are selected.*

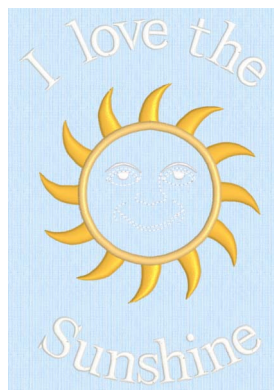

Let's Go Fishing

Surround an embroidery with lettering.

1 If required, choose File > New.

2 Choose mySewnet™ Embroidery > Preferences or , and ensure that the Grid size is set to 5mm.

3 Choose File > Insert. See "Insert" on page 25.

4 Browse to mySewnet/Samples/Embroidery/Stitch.

5 Scroll down to "Crane in Pond.vp4".

- 6 Click to load the embroidery into the work area. The embroidery has white or blue handles on its selection box, depending on the Resize \mathbb{Z} mode.
- 7 In the Lettering window **A**, choose the Traditional font category from the pop-up menu.
- 8 Click the displayed font, and in the font viewer scroll to the Traditional category and choose Arial 14-20mm.
- 9 Ensure that ColorSort is selected (checked).
- 10 Enter the words "Let's Go" in the Letters text box.
- 11 Press Option-Return to start a new line.
- 12 Enter the word "Fishing".



- 13 In the Lettering Shape area, click Full Circle.
- 14 Click Apply. The lettering appears in the center of the work area surrounding the embroidery. Its handles are green.

The green handles indicate that the lettering has not yet been fixed as an embroidery. If the lettering does not surround the embroidery, the embroidery was not selected. Click to select it, then click Apply again.

- 15 A larger size may look better. Control-click the lettering and choose Delete from the menu to delete the lettering.
- 16 In the Lettering window, click the up arrow to change Size to 16mm.
- 17 Select the embroidery and click Apply.

- 18 Drag the square green handle at the top of the circle of lettering downwards. The circle becomes smaller, but the size of the letters is unaffected.
- 19 Undo your change. The circle returns to its original size.



- As the main subject of the embroidery is on the left side, the lettering does not appear to be centered.
- 20 Hold down the Shift key and drag the square green handle at the top of the circle approximately one grid square to the left. The "Let's Go" lettering moves around the left edge of the circle so that the "L" in "Let's" is nearer the left side of the tree in the crane embroidery. The design now looks more balanced. Use $\mathbb{K} \rightarrow$ or $\mathbb{K} \leftarrow$, if needed, to change between selecting the embroidery and the lettering, or use the FilmStrip.
 - 21 Press $\mathbb{K} \rightarrow$ or $\mathbb{K} \leftarrow$ to select the lettering, if it is not selected.
 - 22 In the Control Panel, click Design \mathbb{E} . The Design window appears.
 - 23 Note that there is only one color for the letters (the ColorSort option ensures that the minimum number of colors are used).
 - 24 In the toolbar, click Select All Visible \mathbb{A} and then click Group \mathbb{G} . The crane embroidery and the lettering are grouped as a multipart embroidery. See "Group" on page 91.

The grouped embroidery now has orange handles. Use Reveal Groups \mathbb{R} to adjust the lettering separately.

Note: When exported, an embroidery is automatically combined and ColorSorted.

Individual Letter Monogram

- In the Lettering window, click the displayed font, and scroll down until you see the Monogram font category.
Note: These fonts have most characters of equal width, designed for monograms. They are all upper case only.
- Choose Athletic Square 2C UC 30-80mm and click OK.
This is a two-color monogram font.
- Enter the letters "OTG" in the Letters text box.
Since this is an uppercase font, it is not required to enter uppercase letters.
- In the Lettering Shape pop-up menu, click Horizontal Line.
- Select the checkbox labeled "Individual".
- In the Stitch Type pop-up menu and choose Pattern Fill.
The stitch type can be changed in the Letter window before the lettering is created. To change the stitch type for lettering placed in the work area, Control-click each letter separately and select the stitch type from the context menu.
- In the Pattern Fill properties dialog, click the Pattern button.
- In the Pattern viewer, choose Diamonds from the pattern pop-up menu.
- Click the pattern in row 1, column 1 (number 97).
- Click OK to return to the Letter window.
- Click Apply. Each letter forms a separate block, with its own handles.
- Drag the lettering towards the top of the screen. The pointer changes to the Move  pointer, and the lettering moves as a block.
- Click outside the lettering. None of the letters are now selected.
- Click the "T". It alone is surrounded by a selection box.
- Drag the top right green handle up and to the right, until the T is approximately twice the height, and one and two-thirds the width, of the other two letters.
- Drag the T to the left so that it is midway between the two letters.
- Alternatively, use the arrow keys to nudge the T into position.
This forms a simple three-letter monogram.
Note: To create monograms with different fonts for the large and small letters, use the ExpressMonogram Assistant.

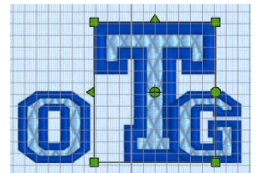
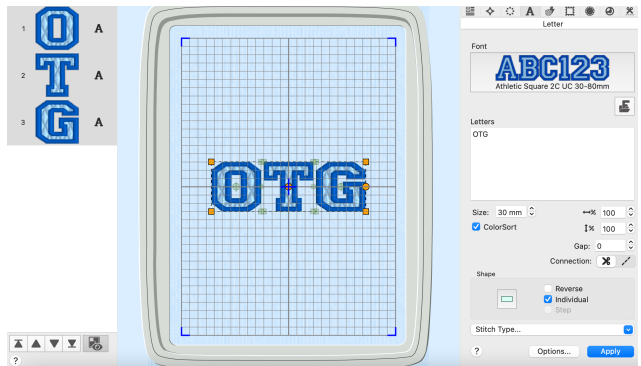

18 In the Control Panel, click Design. The Design window appears. As only the T is selected, only the two threads for the T can be seen in Color Select.

19 Click Select All Visible  in the toolbar. All three letters are surrounded by selection boxes again. See “Select All Visible” on page 89.

20 Choose Design > Combine Selected. See “Combine Selected” on page 30.

The three letters are combined and fixed as a single embroidery. In Color Select separate threads can be seen for each of the three letters.

21 Choose Design > ColorSort. There are now only two thread colors. See “ColorSort” on page 86.

You could also change the thread colors for single letters in the monogram. See “Change the Colors in Lettering” on page 399.

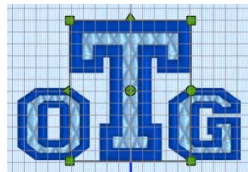

Edit Lettering

You can adjust lettering after it has been placed in the work area, but before it has been fixed as an embroidery.

Note: A block of lettering that has not been fixed as an embroidery has green handles. Lettering fixed as an embroidery has white or blue handles, depending on the Resize setting. See “Resize and Scale” on page 96.

To Adjust Lettering

- Drag the green handles to change the size and arrangement of a block of lettering. See “Lettering Shapes” on page 366.
- Control-click a block of lettering and choose an option from the context menu:
 - Choose Properties to change the text, proportions, connection and line formatting. See “Changing Letter Properties” on page 398.
 - Choose a stitch type and open its properties dialog to alter properties such as density, pattern, angle and stitch length. See “Choosing Stitch Properties” on page 462.
- To change the thread colors in the lettering, in the Control Panel click Design, then click a thread color. See “Color Select” on page 78.
- Fix the lettering as an embroidery. See “Fixing Lettering as an Embroidery” on page 400.

Edit the Stitch Type

You can edit the stitch type of lettering placed in the work area.

Note: If the lettering is placed as individual letters, each letter must be changed separately.

To edit a Stitch Type

- Control-click the lettering and choose a stitch type from the context menu. The properties dialog for the stitch type opens.

Change the Fill in Lettering

- 1 In the Lettering window, click the displayed font, and in the Search  box enter Inform UC 25-120mm QS. Click to select the font. This is an uppercase font using QuiltStipple fill.
- 2 Enter the name "Alex" in the Lettering window. See "Create Lettering" on page 356.
- 3 Under Lettering Shape, ensure that Individual is not selected, then click Apply. The lettering appears in the work area.
- 4 Drag the lettering towards the bottom of the screen.
- 5 Control-click the lettering and choose QuiltStipple Fill from the context menu. The QuiltStipple Fill properties dialog opens.
- 6 Set the Type to Straight.
- 7 Click OK to close the QuiltStipple Fill dialog. The fill now uses straight lines.
- 8 Open the QuiltStipple Fill dialog again.
- 9 Set the Spacing to 2 mm.
- 10 Click OK to close the QuiltStipple Fill dialog. The lines in the fill are now more widely spaced.

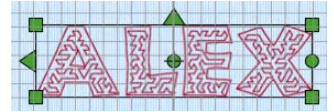
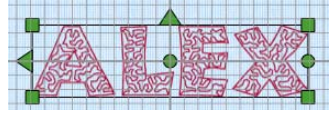

Letter Properties

Use the Letter Properties dialog to alter the font, lettering shape, text, proportions, connection and line formatting when editing lettering.

Note: Letter properties may not be changed once the lettering has been converted to embroidery.

Choose a different font Reduce the number of colors Change the spacing between the letters

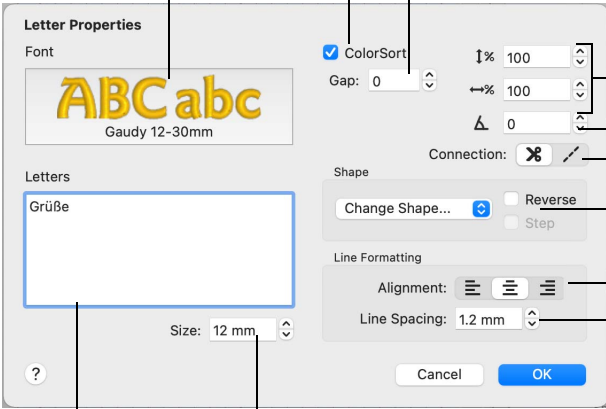

Letter Properties

Font

ABC abc
Gaudy 12-30mm

Letters

Grüße

Size: 12 mm

ColorSort Gap: 0

↑% 100 ↓% 100

↔% 100

△ 0

Connection:

Shape

Change Shape... Reverse Step

Line Formatting

Alignment:

Line Spacing: 1.2 mm

Cancel OK

Change the lettering text Change the font size

Change the height and width proportions of your lettering

Rotate the lettering

Select a connection method

Change the lettering shape

Align the lettering

Set the spacing between lines

To change lettering before you have clicked Apply, use the Letter window and Letter Options dialog. See "Letter Options" on page 365.

To open Letter Properties

In the work area, Control-click the lettering, and choose Properties from the context menu.

Note: You must Control-click directly on the text, or inside the circle for circular lettering shapes. If you click outside the text, a different context menu will appear.

Font

The font used for this lettering is shown. Click to change the font.

Letters

The Letters text box shows the current text. Edit the text as desired.

To start a new line of text, or break an existing line in two, use Option-Return. Scroll to see multiple lines of text.

Note: You can check the spelling of the text. See “Spelling Checker” on page 364.

Size

Font Size can be set from 3mm to 200mm. The size is based on the height of the uppercase 'A' character in the font, and all other characters are sized in proportion to this.

The recommended font size forms part of the name. For instance, Corinthian 15-35mm should be used with Size set from 15mm to 35mm.

Note: If you set a satin font to a very large size, use Satin Properties to choose a pattern which will prevent loose stitching that may catch and pull easily. See “Satin Column” on page 494.

To Change the Font Size

- Enter a number in the Size number box.
- Use the arrows to increase or decrease the size of the font.

ColorSort

Use ColorSort to create lettering with the minimum number of color blocks. See “Lettering Color and ColorSort” on page 399.

- Select (check) ColorSort to use the minimum number of color blocks.

Gap and Kerning

Use Gap to change the spacing between characters in a line of lettering from -99 to +99. A negative value brings the letters closer together and a positive value moves them farther apart. See “Letter Options” on page 365.

Adjusting Spacing Between Letters in a Line

- Enter a number in the Gap number box.
- Use the arrows to increase or decrease the Gap.

- To alter spacing between specific letters, create using the Individual setting.

Height and Width

Adjust height and width separately, to change the lettering proportions from 25% to 400% of the original size, in steps of 1%. For instance, you can make characters taller without increasing their width.

Changing the Height and Width

- Enter a number in the height or width number box.
- Use the arrows to increase or decrease the height or width.

Connection

Use connection to select how the characters are joined together.

Trim : Insert a movement stitch (which will be trimmed if your embroidery machine has this feature) before and after each character in the lettering.

Running Stitch : Join the letters with small stitches. Use Running Stitch connection for small lettering with Nearest Point fonts.

Note: All letters are created as a single color block, rather than each character having its own color block. For multiple lines of lettering with running stitch connection, a trim is inserted between each line.

Lettering Shape

Change the lettering shape, and select Reverse or Stepped lettering. See “Lettering Shapes” on page 366.

Line Formatting

Control how multiple lines of text are arranged relative to each other.

Alignment

Use the Alignment buttons to choose left, center or right alignment.

Note: The Alignment setting does not affect circular lettering shapes.

Line Spacing

Use Line Spacing to change the distance between multiple lines of text. Line Spacing can be adjusted from 1.0 to 5.0.

Changing Letter Properties

Use Letter Properties to change lettering after it has been placed, but before it has been fixed as an embroidery.

Note: To change the stitch type, Control-click the lettering and select the stitch type from the context menu. See “Stitch Type” on page 462.

- I Control-click within the lettering and select Properties from the context menu. The Letter Properties dialog appears.

- 2 Edit the text of the lettering in the Letters text box. Use Option–Return to add extra lines or break up existing lines of text.
Note: You can check the spelling of the text. See “Spelling Checker” on page 364.
- 3 Click the displayed font to change the font in the font viewer.
- 4 Click the displayed lettering shape to change the lettering shape.
- 5 Adjust Size to change the basic size of the lettering. It is recommended to use a size within the range indicated in the font name.
- 6 Click the arrows for height and width to change the proportions of the lettering. Alternatively, enter a size in the number box.
- 7 Adjust Gap to change the spacing between the letters. Click the arrows, or enter a value.
- 8 Select Trim or Running Stitch as the connection method.
- 9 Select the alignment of the line of lettering. Click Left, Center or Right, as desired.
- 10 Click the arrows for Line Spacing to set the distance between multiple lines of text.
- 11 Click OK to apply your changes to the selected lettering.

Lettering Color and ColorSort

The ColorSort option sets whether all the characters in a single-color font are placed as a single color block, or whether each character in the lettering is initially placed as a separate color block. This allows you to use different colors for each character, or the same color for all characters.

Note: If Running Stitch Connection is selected, a single color block is always used.

For multicolor fonts, each character has its own sequence of color blocks.

Note: When you export an embroidery for stitching, it is ColorSorted unless you change the default options.

Change the Colors in Lettering

- 1 In the Letter window, ensure that ColorSort is not selected (checked).
- 2 In the Control Panel, click Design . The Design window appears.
The thread colors for each letter can be seen in the Color Select area. There is a color block for each color in every letter.
- 3 Click the top color in the list. The Color Selection dialog opens. See “Color Selection Dialog” on page 79 for more information.
- 4 Change the color to a contrasting color.
- 5 Click OK to close the dialog.
In the work area one of the colors in the first letter in the text has changed. Use Color Select to change the color of individual letters in your lettering.
- 6 Control-click the lettering, and choose Fix as Stitches in the Context menu.
In the work area the handles on the lettering are now white. The lettering has been fixed as an embroidery.
- 7 Click Design > ColorSort. There is now only a single occurrence of each color. See “ColorSort” on page 86.
- 8 Chose Edit > Undo twice to reverse the sorting of the colors. The lettering has green handles again.

You can use the Colored Pencils to rapidly change groups of letters to different colors. Then, after using ColorSort, change the remaining single colors to the actual desired colors. See “Colors Window” on page 83.

Fixing Lettering as an Embroidery

Lettering is fixed as an embroidery when it is Combined with another design, or when Fix as Stitches is used. See “Fix as Stitches” on page 30.

If lettering is selected when opening the Modify  window, it will be fixed. The stitches are then created, and any further resizing of the embroidery may affect stitch density and length. The stitch properties, for example the density, pattern, angle or stitch length, may not be changed after it is fixed.

Note: When lettering is fixed as an embroidery, the handles change from green to white or blue. After lettering has been converted to embroidery, it can no longer be changed with Letter Properties.

To Reverse Fixing as an Embroidery

- Control-click and select Undo from the context menu.

Use QuickFont to create fonts automatically for use with your mySewnet™ Embroidery Software, or your embroidery machine.





Create a font automatically from a TrueType® or OpenType® font on your computer for use with your mySewnet™ Embroidery Software, or certain HUSQVARNA VIKING® or PFAFF® embroidery machines.



To create a font

- In Font Manager , click QuickFont .
- Click the QuickFont icon  in the Launchpad.
- Double-click the QuickFont icon  in the Finder.

Use mySewnet™ QuickFont

- 1 Open the Letter window  and click to launch Font Manager .
- 2 In Font Manager, click QuickFont . Alternatively, click the QuickFont icon  in the Launchpad.

Note: Progress through the pages using Continue and Go Back.

- 3 Choose a font on your computer as a base for your embroidered font.
- 4 Select a stitch type for your font.
- 5 Name the font and print a catalog.
- 6 Click Done to create and save the font.

How to Create a Font

Select Font

- 1 Start QuickFont . The Select Font page appears.
Note: The initial settings in QuickFont are remembered from the last time it was used.
- 2 In the Font pop-up menu, choose the desired font name. The previews to the right of the window change with the font choice.

- 3 In the Typeface pop-up menu, choose the desired style, for example Regular, Light, Bold or Oblique. The options will vary according to the selected font. The previews to the right of the window will change according to the style choice.
- 4 Select a File Type. Choose between:
 - A font to use in the mySewnet™ Embroidery Software
 - A font to use on your embroidery machine.
- 5 In the Character Set pop-up menu, choose the desired set. The choice of character set will vary, depending on the File Type chosen above.
- 6 Click Continue. The Set Stitch Options page appears.

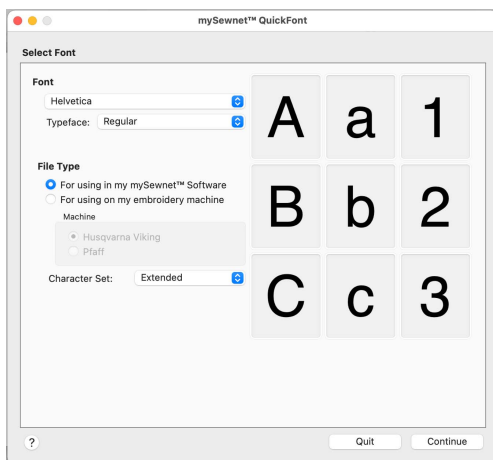

Set Stitch Options

- 7 In the Stitch Type pop-up menu, choose the desired Stitch Type. The Output Size may change according to the selected Stitch Type. The previews to the right of the window will change according to the selected Stitch Type. For a mySewnet™ Embroidery Software font, the preview is in the middle of the range. The first three uppercase characters, lowercase characters and numbers are previewed. The size for the 'A' and 'a' characters are set half way between the Minimum and Maximum output size for a mySewnet™ Embroidery Software font, or the characters are set as near as possible to the Output Size for a machine font. The Real Size % box shows the size of the previews, compared to the Real Size setting in mySewnet™ Configure.

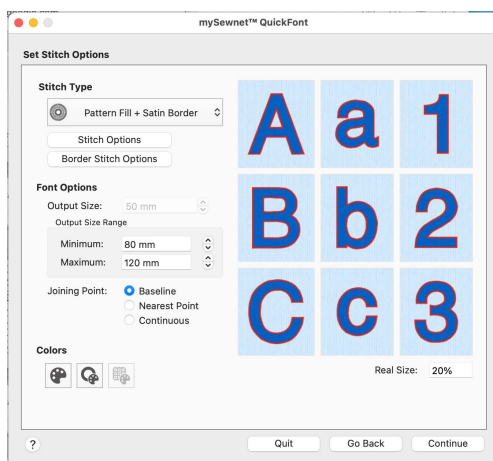

- 8 If desired, click **Stitch Options** and/or **Border Stitch Options** and change the settings for the selected Stitch Type, such as the fill pattern or satin border width.
- 9 To change the thread color used for satin columns or pattern fill areas, click the **Fill Thread Color** button. The Color Selection dialog appears for you to choose a new color.
- 10 To change the thread color used for satin borders, appliqué borders and outlines, click the **Border Thread Color** button. The Color Selection dialog appears for you to choose a new color.

Note: After you have chosen a new thread color, the previews are shown with the new color.

11 To change the color used for appliqué fabric, click the Appliqué Color button . The Appliqué Selection dialog appears for you to choose a new color.

12 If desired, adjust the Output Size (for a machine font), or Output Size Range (for a mySewnet™ Embroidery Software font).

13 In Joining Point, select Baseline to join letters at the bottom, select Nearest Point to join letters at the place where they are closest for fast stitchout of a small font, and use Continuous for a flowing handwriting effect with a script font.
Note: Joining Point options are only available with a mySewnet™ Embroidery Software font.

14 Click Continue. A generating preview message appears, saying that the font is being created. The Output Options page then appears.

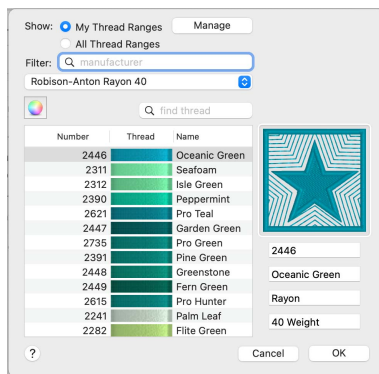

Output Options

15 The Font Name is automatically generated to show the TrueType® font name, then the style name (for example, Regular), then the Stitch Type (S for Satin, F for Fill, FSB for Fill + Satin Border, SB for Satin Border, A for Appliqué or O for Outline), then the character set (E for Extended, SE for Super Extended and so on). At the end is the minimum and maximum recommended sizes in millimeters (for a mySewnet™ Embroidery Software font), or the Output size (for a machine font). If desired, click in the Font Name box to change the name.

16 The mySewnet Font Category is initially set according to your choice of Joining Point. It is set to My Fonts for Baseline joining, Nearest Point for Nearest Point joining or Script for Continuous joining. If desired, choose a different category from the pop-up menu.

Note: mySewnet Font Category is not available when creating a machine font.

17 Machine fonts are saved to mySewnet/My Designs by default. If desired, you can choose a different folder, or save to a USB stick. Click the button with the ellipsis (three dots) to choose a new folder or drive.

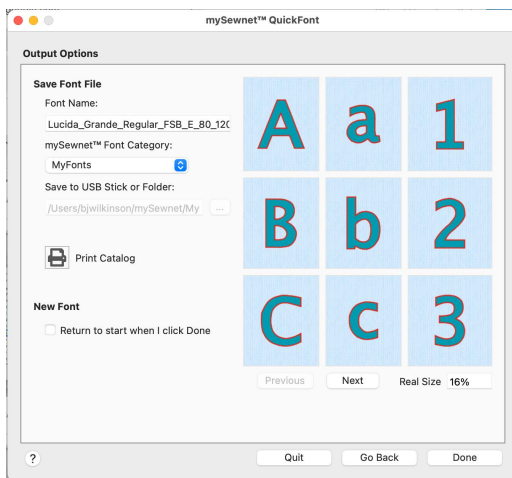

18 To view the complete font, use the Previous and Next buttons below the preview to step through the character set.

19 To print a reference sheet showing the characters in the font, click Print Catalog.

20 To start a new font after creating the current one, select the "Return to start when I click Done" checkbox.

21 Click Done and QuickFont will close. The font is saved according to the selected options.

Select Font

Choose a font

Choose a style

Create a font for your computer

Create a font for your machine

Choose a character set

Preview the font

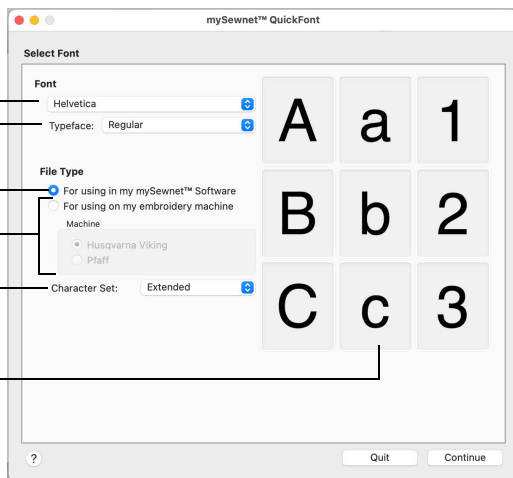

Use the Select Font page of mySewnet™ QuickFont to select the font, typeface and character set on which to base the new font. Also select whether to make a font for use in the mySewnet™ Embroidery Software, or for use on certain HUSQVARNA VIKING® or PFAFF® embroidery machines. The previews to the right of the window change with your choices.

Select a Font

- 1 Choose a font in the Font pop-up menu.
- 2 Choose a style for your font in the Typeface pop-up menu, for example bold or oblique.
- 3 Select to use the font with your mySewnet™ Embroidery Software, or for your embroidery machine.
- 4 If you chose to create a font for your embroidery machine, select between Husqvarna Viking and Pfaff.
The machine choice is only available when creating a font for an embroidery machine.
- 5 Choose a Character Set in the pop-up menu.
Your selected font is shown in the preview.

Font

Choose the desired font by name from the TrueType® and OpenType® fonts on your computer.

- Choose a font from the pop-up menu.

Typeface

Choose a typeface from the list available, which varies depending on the selected font.

- Choose a typeface from the pop-up menu.

File Type

Make a font to use with the mySewnet™ Embroidery Software, or for use on your HUSQVARNA VIKING® or PFAFF® embroidery machine.

For using in my mySewnet Software: Create a font file for use with mySewnet™ Embroidery and other mySewnet™ Embroidery Software apps.

For using on my embroidery machine: Create a font file for use with your embroidery machine.

Machine

Select which machine type the font is for:

- Husqvarna Viking
- Pfaff

Note: This option is only available if 'For using on my embroidery machine' was selected in File Type.

Character Set

Choose a character set from: Extended, Super Extended, Western 1, 2, 3 and 4, Cyrillic 1 and 2, and Hiragana 1.

- Choose a character set from the pop-up menu.

Different character sets are available, depending on the selected file type.

Font Format	Character Set	Default Set
mySewnet™ Embroidery Font	Extended Super Extended Latin 1 Cyrillic 3 Hiragana 2 Greek 1 Hebrew 1	Extended
HUSQVARNA VIKING® Font	Western 1 Western 2 Western 3 Cyrillic 1 Hiragana 1	Western 1
PFAFF® Font	Western 4 Cyrillic 2 Hiragana 1	Western 4

Note: The more characters in a font, the greater the amount of time needed to create that font. Nearest Point fonts require four versions of each character. Therefore, such a font will take four times as long to be created.

Western 2

The Western 2 character set contains fewer characters. Generally, it will convert to a font more quickly than the other character sets. The following characters are in the Western 2 character set:

ABCDEFGHIJKLMNOPQRSTUVWXYZÄÅÖ-
abcdefghijklmnopqrstuvwxyzääö,
1234567890Æø?!, , .

Western 3

The following characters are in the Western 3 character set:

ABCDEFGHIJKLMNOPQRSTUVWXYZÄÅËÖ-
abcdefghijklmnopqrstuvwxyzääëö,
1234567890øääåçèéëíóùúÿñ&?!'@, .

Western 4

The following characters are in the Western 4 character set:

ABCDEFGHIJKLMNOPQRSTUVWXYZ., -
abcdefghijklmnopqrstuvwxyz., -
ÄÅÖËÏÊËÏÑÇŠŠ&?!¿;,
ääääääääèèèèìíîïòóôõøøùúûüçñ@
1234567890., ; - += % \ / * ^ ? ~ ` ' " _

Cyrillic, Hiragana, Greek and Hebrew fonts

Cyrillic, Hiragana (Japanese), Greek and Hebrew fonts are also available.

Note: Creating Cyrillic, Hiragana, Greek and Hebrew fonts requires a TrueType font with the relevant set of Unicode characters.

Cyrillic 1

The following characters are in the Cyrillic 1 character set:

АБВГДЕЖЗИЙКЛМНОПРСТУФХЦЧШЩЪЫЬЭЮЯ
абвгдежзийклмнопрстуфхцчшщъыьэюя
1234567890Æøääåçèéëíóùúÿñ&?!'@

Cyrillic 2

The following characters are in the Cyrillic 2 character set:

АБВГДЕЖЗИЙКЛМНОПРСТУФХЦЧШЩЪЫЬЭЮЯ
абвгдежзийклмнопрстуфхцчшщъыьэюя
1234567890ëÿ©§&? \$€%:;`'*=!-+.,

Greek I

The following characters are in the Greek I character set:

ΑΒΓΔΕΖΗΘΙΚΛΜΝΞΟΠΡΣΤΥΦΧΨΩ

αβγδεζηθικλμνξοπρςστυφχψω

ΑΕΗΙΪΟΥΎΩ

άέήίϊΐόύϋώ

0123456789

!"@#%&*()_+\/?<>'\"":;.,

Hebrew I

The following characters are in the Hebrew I character set:

אבגדהוזחטיכךלממנספפצקקרש

ווייבש

אבגדהוזחטיכךלממנספפצקקרש

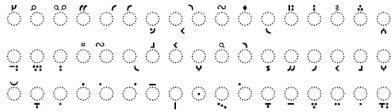

Set Stitch Options

Choose a stitch type for the font

Set the properties for the font fill

Set properties for the font outline

Set the size for a machine font

Set the minimum & maximum size for a mySewnet software font

Select a joining method for the font

Set the colors for the fill, border and appliqué

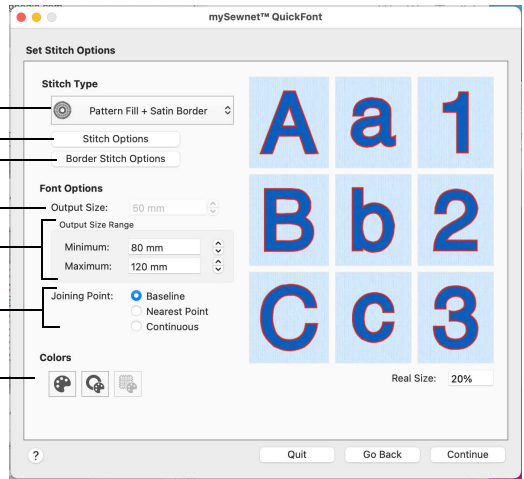

Use the Set Stitch Options page of mySewnet™ QuickFont to select the type of stitching used to create the characters, the default colors, the recommended size range or font size, and the joining method.

Select the Stitch Type and Character Size

- 1 Choose a Stitch Type in the pop-up menu, for example satin columns, fill with or without a border, appliqué or an outline.
- 2 Click the Stitch Options button to change the properties for satin columns, a fill or appliqué. The properties dialog for the stitch type opens. Make the desired changes and save.
- 3 Click the Border Stitch Options button to change the properties for a border, appliqué border or outline in its properties dialog.
- 4 Click the Fill Thread Color button to change the color of the fill or columns in the Color Selection dialog.
- 5 Click the Border Thread Color button to change the color of the border or outline in the Color Selection dialog.
- 6 Click the Appliqué Color button to change the color of the appliqué fabric in the Appliqué Selection dialog.
- 7 Use the arrows or enter a number in Output Size or Output Size Range to set the size, or maximum and minimum recommended size, for the font.

Note: The suggested size varies according to the chosen stitch type. Output Size is for fonts used with an embroidery machine, and Output Size Range is for fonts used with mySewnet™ Embroidery Software.

- 8 Select a Joining Point method.

Note: Baseline is for general use, Nearest Point is for running stitch connection in small fonts, Continuous is for script (handwriting) fonts.

Your selected stitch options are shown in the preview.

Stitch Type

- Choose a stitch type from the pop-up menu, then click the stitch options and thread color buttons to set the stitch properties and thread colors for the font.

Use Stitch Type to choose the types of stitching used for the characters in the font.

Satin : Create characters using Satin Columns.

Pattern Fill : Create characters using Pattern Fill areas.

Pattern Fill + Satin Border : Create characters using Pattern Fill areas outlined with a Satin Border.

Satin Border : Create characters using satin borders.

Appliqué : Create characters with appliqué fabric and placement lines, finished with a satin border.

Outline : Stitch an outline around the characters using a running, double or triple stitch outline.

After selecting the desired Stitch Type, click the Options buttons to choose the stitch settings for creating lettering with the font.

Stitch Options

Choose the properties for any Satin Column or Pattern Fill in the font, or the Appliqué Method. These stitch types are used with the following area types:

- Satin
- Pattern Fill
- Pattern Fill + Satin Border
- Appliqué

Note: Most properties may also be changed when placing the lettering from your font in mySewnet™ Embroidery.

- Click Stitch Options and set the stitch properties for the area types used in the font.

Border Stitch Options

Choose the properties for any satin line, running stitch, double stitch or triple stitch in the font. These stitch types are used in the following border and line types:

- Pattern Fill + Satin Border
- Satin Border
- Appliqué
- Outline

Note: Most properties may also be changed when placing the lettering from your font in mySewnet™ Embroidery.

- Click **Border Stitch Options** and set the stitch properties for the line types used in the font.

Satin

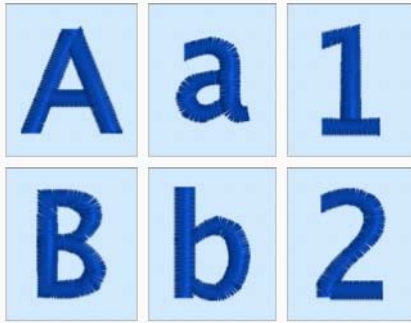

Create characters using Satin Columns.

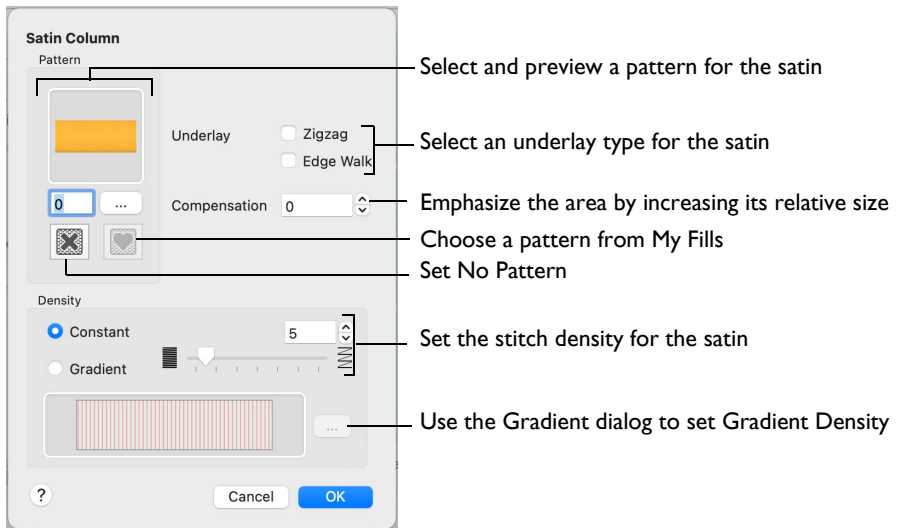

Use the Satin Column options to set the satin density, satin pattern and underlay methods.

Pattern

Choose from more than 250 patterns for satin (for areas wider than around 8-10mm). The initial setting is 0. Add new patterns using Manage My Fills in mySewnet™ Digitizing. See “Satin Column” on page 494.

View the patterns in the pattern viewer. See “Fill and Satin Patterns” on page 511.

Note: Patterns can only be used for columns wider than about 8-10 mm.

- Click a pattern sample or enter the Pattern number to select a pattern.
- Set the Pattern number to 0 for standard satin with no pattern, or click No Pattern.

Underlay

Use zigzag or edge walk underlay.

- Zigzag creates zigzag lines of running stitch as underlay. Use zigzag underlay for larger fonts which have wide areas of satin.
- Edge walk places lines of running stitch just inside the edges of the satin columns. Use edge walk for larger fonts when the satin columns are not very wide.

- Select Zigzag or Edge Walk underlay.

For larger bold characters, which give very wide areas of satin, select both underlay types. The underlay options are initially deselected.



Edge Walk

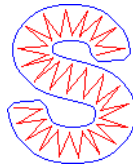

Zigzag

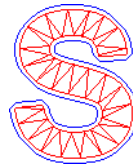

Edge Walk plus
Zigzag

Compensation

Compensation is used to make an area 'bolder' by increasing its relative size. Set Compensation from 0 to 30. The higher the number, the bolder the area appears. The initial setting is 0.

Density

Constant density creates a uniform satin at the chosen density. Gradient density creates a satin with varying density or color.

Setting Constant Density

The lower the number, the closer together the stitches and the more stitches are produced. You can set Density from 2 to 40.

- Select Constant, then use the slider or the number box to set the Density.

Setting Gradient Density

- Select Gradient, then click the ellipsis button (3 dots) to open the Gradient dialog. See “Gradient” on page 466.

Pattern Fill

Create characters using pattern fill areas.

Use the Pattern Fill options to select the fill pattern, fill density, stitch angle and underlay type.

See “Pattern Fill” on page 419.

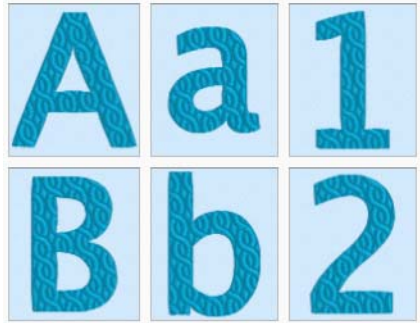

Pattern Fill + Satin Border

Create characters using Pattern Fill areas outlined with satin borders.

Use the Pattern Fill options to select the fill pattern, fill density, stitch angle and underlay type for the fill.

See “Pattern Fill” on page 419.

Use the Satin Border options to select the satin border density and width.

See “Satin Border” on page 420.

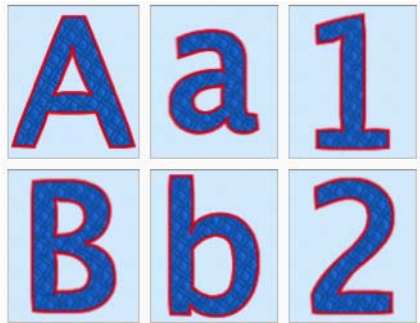

Satin Border

Create the characters using satin borders.

Use the Satin Border options to select the satin border density and width.

See “Satin Border” on page 420.

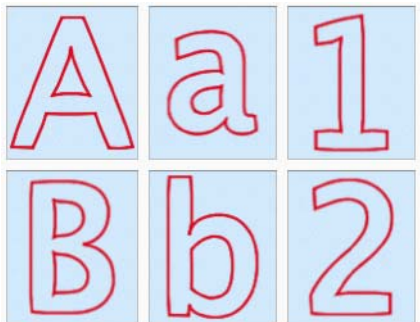

Appliqué

Create characters using appliqué fabric and a satin border.

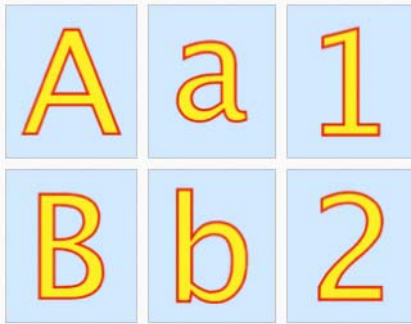

- Click **Stitch Options** to set the **Appliqué Options**, and click **Border Stitch Options** to set the **Satin Line** options. Click the **Appliqué Color** button to change the color of the appliqué fabric in the **Appliqué Selection** dialog.

Use the **Appliqué Options** to choose an appliqué method, set the **Appliqué Piece** margin, and whether to match the placement line to the margin.

Use the **Satin Line** options to select the satin border density and satin border width.

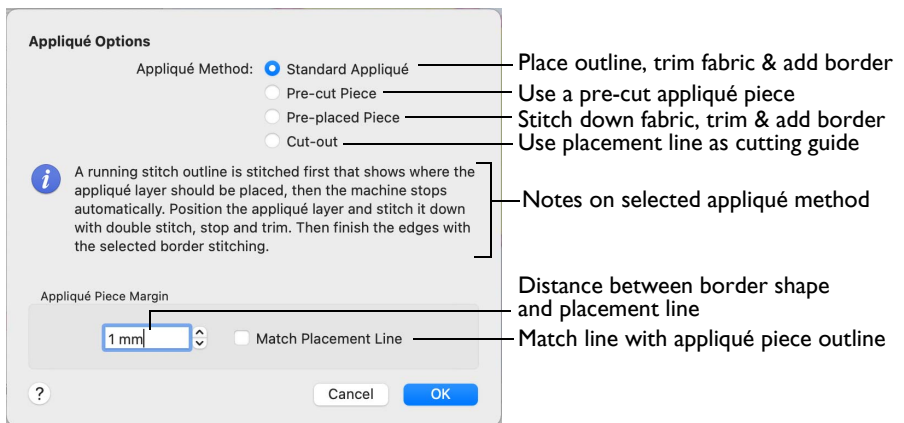

Appliqué Method

Choose the method for placing and securing the appliqué fabric.

- **Standard Appliqué**
Stitch a running line to show where appliqué fabric should be placed, then stop to position the fabric. Stitch down the appliqué fabric with double stitch, then stop so the fabric may be trimmed. Finish the edges with the selected border stitching.
- **Pre-cut Piece**

Use a pre-cut appliqué piece; created, for example, using an automatic cutter or cutwork needles.

Stitch a running line to show where the pre-cut appliqué piece should be placed, then stop to position the appliqué piece. Stitch down the appliqué piece with double stitch, then finish the edges with the selected border stitching.

■ Pre-placed Piece

Place the appliqué fabric before stitching.

Place the appliqué layer in position, then stitch down the appliqué fabric with double stitch. Stop so the fabric may be trimmed. Finish the edges with the selected border stitching.

■ Cut-out

Use the appliqué placement line as a guide to where the fabric should be cut; for example for reverse appliqué.

Stitch a double stitch line. Stop so the fabric may be cut to form a hole defined by the stitched outline. Finish the edges with the selected border stitching.

Appliqué Piece Margin

Set the margin for appliqué placement relative to the drawn border shape from -10mm to 10mm. The initial value is 1.0mm.

Note: Use a positive value when trimming the appliqué fabric before the border is stitched, for example with Standard Appliqué and Pre-placed Appliqué. A negative value is recommended for cut-out and reverse appliqué.

Match Placement Line

Adjust the position of the first running stitch line for either Standard Appliqué or Pre-cut Piece so that it matches the outline of the appliqué piece after the Appliqué Piece Margin has been applied.

Note: This may be useful for precise positioning of appliqué pieces that have been pre-cut with an automated cutter, to ensure the placement line is visible.

Stitching Out an Appliqué Character

Appliqué embroideries are designed to be stitched out in a particular sequence. When stitching out an appliqué embroidery using Standard Appliqué, do as follows:

- 1 Begin embroidering. A running line will show where to position the appliqué fabric.
- 2 A stop then allows you to place the fabric.
- 3 Stitch down the appliqué fabric with double stitch.
- 4 Next there is a color change so you can trim the fabric, and change the color for the first color of the embroidery.
- 5 Finally, finish the edges with the satin border.

Note: The placement section in the appliqué is the same color as the first color in the character, so it doesn't show under the appliqué fabric. If desired, change in mySewnet™ Embroidery to the first color of the embroidery.

Outline

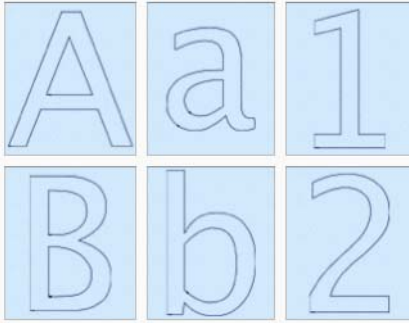

Stitch the characters as an outline using running, double or triple stitch.

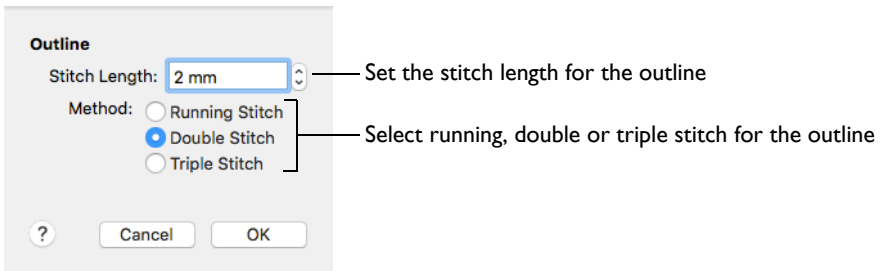

Use the Outline options to select the outline method and stitch length.

Stitch Length

The same stitch length is used by all methods. Set the stitch length from 1 to 12mm in 0.1mm steps. The initial setting is 2mm.

Method

Select Running, Double or Triple stitch for the character outline.

- Running Stitch is a single continuous line of stitches.
 - Double stitch stitches the full length of a line and then retraces the same path back to the starting point, resulting in a double strand of stitching.
 - Triple stitch places three stitches for each stitch placed by running stitch (one forward, one back and another forward) resulting in a triple strand of stitching.
- The initial setting is Running Stitch.



Running



Double



Triple

Pattern Fill

Use the Pattern Fill dialog to set the properties on a pattern fill area. See “Pattern Fill” on page 463.

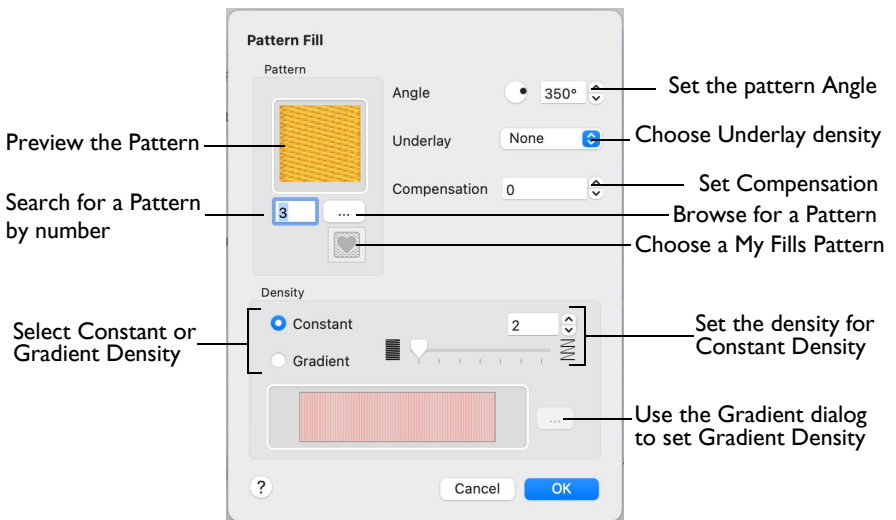

Note: Changes to the Pattern Fill settings will affect the fill options for Pattern Fill as well as for Pattern Fill + Satin Border.

Pattern

Choose a fill pattern in the Pattern viewer. See “Fill Pattern” on page 420.

Density

Constant density creates a uniform fill at the chosen density. Gradient density creates a fill with varying density or color.

- Select between Constant and Gradient density.

Angle

The angle of the fill pattern, as shown by the rotational slider and number box. The thread is at a right angle to the fill pattern. You can set the Angle from 0 to 359 degrees.

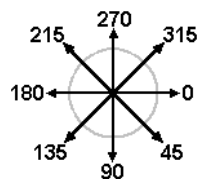

Underlay

Underlay is a low density fill that is perpendicular to the stitches of the actual fill area. It is useful for stabilizing large fill areas.

- Choose None, Low, Medium or High density underlay from the pop-up menu.

Compensation

Compensation is used to make an area 'bolder' by increasing its relative size. The higher the number, the bolder the area appears. The initial setting is 0.

- Click the arrows to set Compensation from 0 to 20, or enter a value in the number box.

Fill Pattern

Use the Pattern viewer to select the pattern used for fill areas. See “Pattern” on page 465.

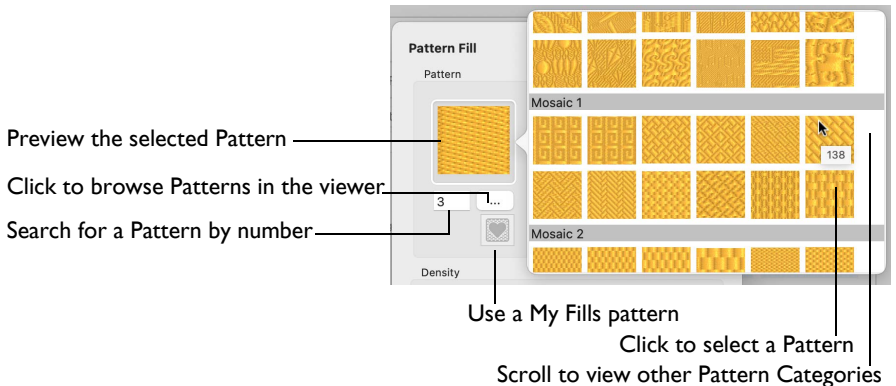

Selecting a Pattern

- Scroll through the pattern viewer, and click to choose a Pattern.
- Enter a Pattern number directly in the Pattern box.

Note: Patterns in categories other than Standard are recommended for use in relatively large fill areas, as they have repeating patterns which work well when 'tiled' together. Pattern 36 produces a 'satin effect' fill stitch. For a complete reference to all the fill patterns that can be used for fonts and SuperDesigns, see the Fill Patterns Sample Guide. This is provided as a PDF for viewing and printing.

Satin Border

Satin Line is a line of constant-width satin stitch. It can be used alone, or as a border. Use the Satin Line options to select the satin border density and width.

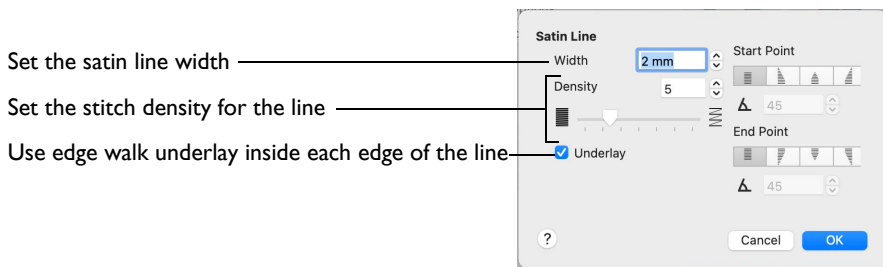

Note: Changes to the Satin Line settings will affect the satin options for Satin Border as well as for Pattern Fill + Satin Border.

Width

Set Width for the satin line from 1 to 12mm in 0.1mm steps. The initial setting is 2mm.

Density

Set Density from 2 to 15. The lower the number, the closer together the stitches and the more stitches are produced. The initial setting is 5.

Underlay

Use this option to place edge walk underlay inside each edge of the satin border.

Note: Underlay is not generated if the Width is set below 2mm.

Output Size and Output Size Range

The character size varies according to the chosen Stitch Type. The initial settings are within the recommended range. The sizes available are:

Stitch Type	Recommended Sizes	Smallest and Largest Sizes
Satin	12 to 30mm	7 to 50mm
Fill	20 to 120mm	10 to 200mm
Fill + Satin Border	80 to 120mm	50 to 200mm
Satin Border	80 to 120mm	50 to 200mm
Appliqué	80 to 120mm	50 to 200mm
Outline	50 to 120mm	25 to 200mm

Output Size is used with fonts created for use on an embroidery machine.

Set the Output Size

- Click the Output Size up and down arrows or enter a number to change the character size.

Output Size Range is used for fonts created for use with mySewnet™ Embroidery Software. The Minimum and Maximum sizes are the recommended sizes for the font. The preview shows the middle size in the range.

Set the Output Size Range

- Click the Minimum up and down arrows, or enter a number, to set the minimum recommended size for the font characters.
- Click the Maximum up and down arrows, or enter a number, to set the maximum recommended size for the font characters.

Joining Point

Set the joining method for the font.

Note: This option is only available for fonts created for use in the mySewnet™ Embroidery Software. It is not available for fonts for use on an embroidery machine.

Baseline

This is the standard joining method. The characters are joined along the 'baseline' on which the characters sit. Use Trim Connection in the Letter window to insert trim commands that trim the long connecting stitches between characters while the lettering is stitched out.

Nearest Point

Nearest point fonts use special logic in mySewnet™ Embroidery to determine the best way to join characters together. Nearest Point is recommended for faster stitchout of small fonts, where connection stitches will be left untrimmed. Choose Running Connection in the Letter window to avoid the need for trimming with small characters. Each character has four versions to give different start (on the left) and end (on the right) points as follows:

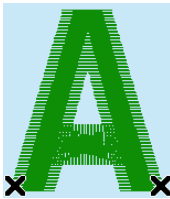

Bottom Left to Bottom Right



Top Left to Top Right

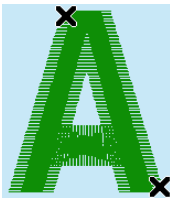

Top Left to Bottom Right



Bottom Left to Top Right

When placing lettering, the correct character versions are automatically selected to give the shortest joining distances between each character. Here, the two Ms

are connected in different ways (top left to bottom right and bottom left to top right):

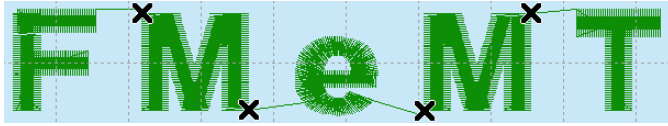

Continuous

Continuous fonts are typically used to give a flowing handwriting effect for script. When continuous fonts are used for lettering, no space is added between the lowercase letters. (The Gap setting is not used.) Therefore, select Continuous for Script fonts where the lowercase letters are joined. All other characters are connected the same way as baseline fonts.

Stitch and Appliqué Colors

Click Fill Thread Color  to change the thread color used for Satin Column and pattern fill areas. The Color Selection dialog appears for you to choose a new color.

Click Border Thread Color  to change the thread color used for satin borders, appliqué borders and outlines. The Color Selection dialog appears for you to choose a new color.

Selected thread ranges

Search by thread number

Use the Colors window to match a color

Click a thread color to select a thread

Choose a thread range

Preview the thread color

View the thread information

Number	Thread	Name
2446	Oceanic Green	
2311	Seafoam	
2312	Isle Green	
2390	Peppermint	
2621	Pro Teal	
2447	Garden Green	
2735	Pro Green	
2391	Pine Green	
2448	Greenstone	
2449	Fern Green	
2615	Pro Hunter	
2241	Palm Leaf	
2282	Flite Green	

After you have chosen a new thread color, the preview shows the new color.

Click Appliqué Color  to change the appliqué fabric color. The Appliqué Selection dialog appears for you to choose a new fabric.

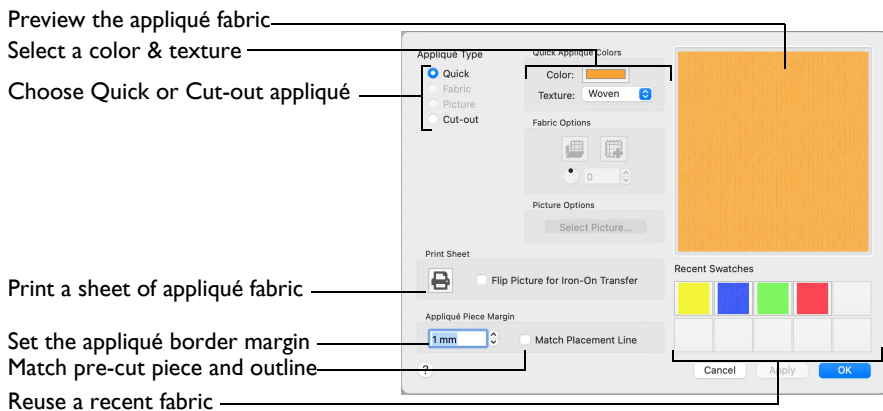

Note: Only Quick Appliqués are available in mySewnet™ QuickFont, to optimize font creation and loading time. You can select a printed fabric when creating lettering with the font.

Output Options

Use the Output Options page of mySewnet™ QuickFont to review the font, to name it, and to select where it will be saved.

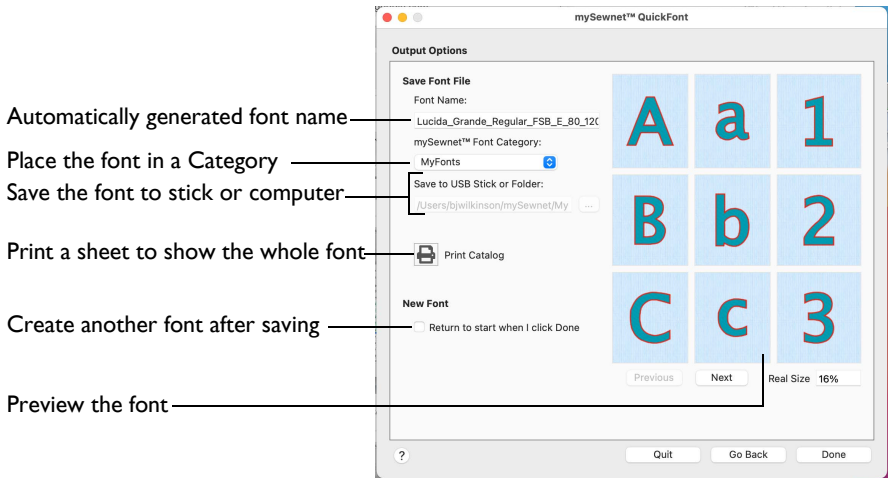

Font Name

The Font Name is automatically generated to show the TrueType® font name, then the style name (for example, Regular), then the Stitch Type (S for Satin, F for Fill, FSB for Fill + Satin Border, SB for Satin Border, A for Appliqué or O for Outline), then the Character Set (E for Extended; SE for Super Extended; W1, W2, W3 and W4 for Western 1, 2, 3 and 4; C1 and C2 for Cyrillic 1 and 2; and H1 for Hiragana 1); then the minimum and maximum recommended sizes in millimeters (or the Output Size for a machine font).

You may change the Font Name as desired.

mySewnet Font Category

The Categories are the same as the categories on the Letter window in mySewnet™ Embroidery.

The Category is initially set according to your choice of Joining Point. It is set to My Fonts for Baseline joining, Nearest Point for Nearest Point joining or Script for Continuous joining.

You may select any Category as desired.

Save to USB Stick or Folder

Set the folder or USB stick where the font is to be saved. The font is saved as a .vf3 (font) file on your computer, or on your USB stick.

By default the font is saved to mySewnet/My Designs/.

Note: This option is only available if the font was selected for using on an embroidery machine.

- Click the ellipses (3 dots) button, and browse to the desired place.

Using a saved font

To use the font on your embroidery machine, do as follows:

- Browse from the embroidery machine using File Manager or Files & Folders and download the font from your computer.
- Save the .v33 file to a USB Embroidery Stick (or copy it using the Finder); then transfer it to your embroidery machine.

Print Catalog

Click the Print Catalog button to print a reference sheet showing the characters in the font.

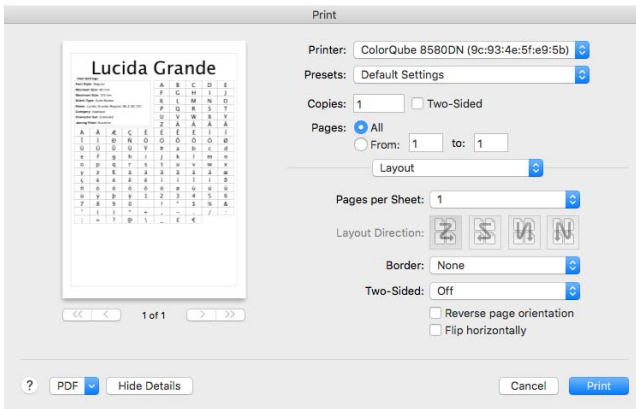

Select Show Details to choose the information to be printed with the catalog, select the printer and page layout, and the number of copies. Then print the catalog. See “Print” on page 517.

New Font

Select the "Return to start when I click Done" checkbox to start a new font when the current font has been created. mySewnet™ QuickFont displays the Select Font page.

Preview

The 3D view boxes allow you to browse through the converted font, showing three uppercase letters, three lowercase letters, and three numbers or symbols. The character order is the same as the selected character set.

Note: You can change the 3D background with mySewnet™ Configure.

Previous

View the previous nine characters.

Next

View the next nine characters.

Real Size%

This box shows how big the 3D view you can see is as a percentage of the real size of the generated stitch files. This depends on the Real Size setting being correct in mySewnet™ Configure.

Create a Pattern Fill Font

- 1 In mySewnet™ Embroidery, open the Letter window **A**, click the Font Manager **F** button, then click the QuickFont button **QF**. Alternatively, click the mySewnet™ QuickFont icon **QF** in the Launchpad, or double-click the mySewnet™ QuickFont icon **QF** in the Finder.

The Select Font page appears.

- 2 In the Font pop-up menu choose the font Lucida Grande. The previews show the appearance of the 'ABC', 'abc' and '123' characters in the font.
- 3 Ensure the Typeface is set to Regular.
- 4 If you are creating a font for use in mySewnet™ Embroidery, choose 'For using in my mySewnet Software'.

If you are creating a font for a machine, select 'For using on my embroidery machine', and choose your machine brand.

Note: The pictures here illustrate using QuickFont to create a font for mySewnet™ Embroidery.

- 5 Select a character set:
 - If you are using QuickFont for mySewnet™ Embroidery, ensure that Extended is set as the Character Set.
 - If you are creating a font for a HUSQVARNA VIKING® embroidery machine, ensure that Western 1 is set as the Character Set.
 - If you are creating a font for a PFAFF® embroidery machine, ensure that Western 4 is set as the Character Set.

Note: These character sets are appropriate for general English text, with letters, numbers and some punctuation.

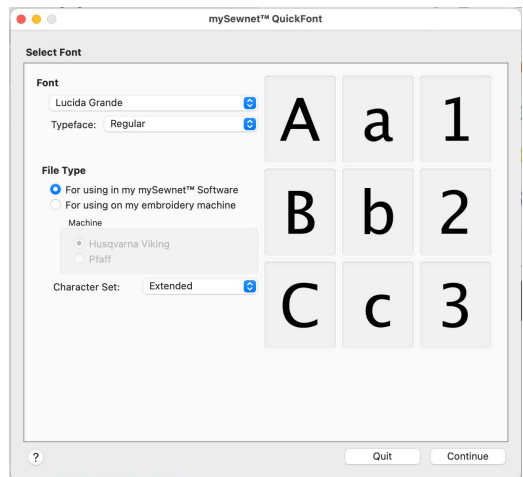

- 6 Click Continue and the Set Stitch Options page appears.
- 7 Set the Stitch Type to Pattern Fill . The previews now show the pattern fill, and the Output Size and Output Size Range values change, as Pattern Fill is suitable for larger letter sizes than the default Satin.

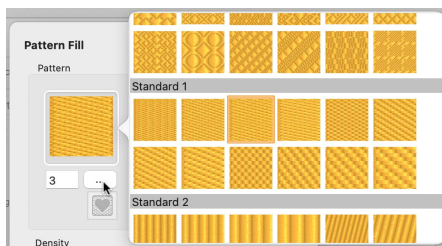

- 8 Click the Stitch Options button and the Pattern Fill dialog appears.
- 9 Click the Patterns button (the button with three dots) to choose a pattern for the fill.
- 10 In the Pattern viewer ensure the Pattern is set to 3 from the Standard 1 category.
- 11 In the Pattern Fill dialog, ensure the Density is set to Constant, and that the value is set to 2.

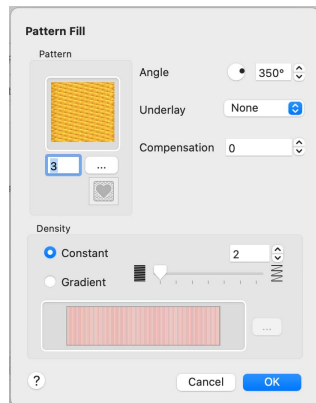

- 12 Click OK to close the dialog.
- 13 Click the Fill Thread Color button  and the Color Selection dialog appears.
- 14 Ensure the Thread Range is set to Robison-Anton Rayon 40.
- 15 Click in the Find Thread box and enter '2409'. Thread color 2409 (Yellow Mist) is found in the list.

- 16 Select the thread, and then click OK. The previews are updated with the new thread color.

- 17 Ensure the Joining Point is set to Baseline, which is the recommended setting for most lettering.
Note: Nearest Point is recommended for faster stitchout of small fonts, where connection stitches will be left untrimmed. Continuous is used for Script fonts where the lowercase letters are joined.

The Joining Point options are only available when creating a font for use in mySewnet™ Embroidery. They are not accessible when creating a machine font.

- 18 Click Continue. The font is generated, and the Output Options page appears.

- 19 Use Next and Previous to preview the other letters in the font.



20 Leave the Font Name unchanged.
Note: The Font Name is automatically generated to show the TrueType® font name, then the typeface (here Regular), then the Stitch Type (F for Pattern Fill), then the Character Set (here E for Extended), then the minimum and maximum recommended sizes in millimeters (or output size for a machine font). Other letter combinations are used for different style and stitch type choices.

21 If you are creating a font in QuickFont for use in mySewnet™ Embroidery, leave the Category as My Fonts. This will save the font to the My Fonts folder on your computer.

22 If you are creating a font for use on a machine, save the font to the My Designs folder on your computer (the default location), or to a USB embroidery stick.

23 If desired, click Print Catalog to print a reference sheet that shows the font details and the characters in the new font.

24 Click Done to close QuickFont.

Note: To use the font in mySewnet™ Embroidery, in the Font viewer, browse to the My Fonts Category. The font Lucida_Grande_regular_F_E_20_120 is previewed in the font display. The Font viewer automatically detects and previews any new fonts you add to My Fonts, and the font can be used in the same way as the system fonts.

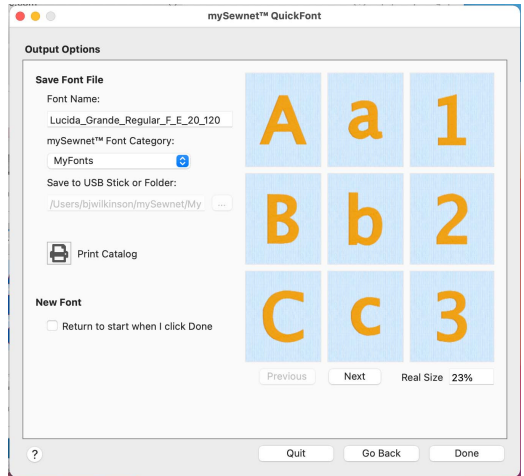

Font Guidelines

About Fonts

On a computer, a font is a set of characters which all have the same style of design.

TrueType® and OpenType® Fonts

TrueType® fonts are the standard for fonts used by computer programs.

OpenType® fonts are similar to TrueType® fonts but with extra features such as an extended character set.

Postscript Type I Fonts

This was the first widely used font standard in the computer industry, originally as a way of having standard fonts for computers and printers. These are also known as Adobe® Type I fonts. mySewnet™ QuickFont does not support Postscript Type I fonts.

Font Variations

Many fonts are supplied with separate style definitions, for example Regular, Bold, Italic and Bold Italic.

Complexity

There are various factors that will increase or decrease the complexity of a font. Extremely complex fonts will convert rather slowly, especially if converting to Satin.

Serif

Serifs are the small slabs, blocks, caps or other detail that are placed on the ends of character arms, and sometimes also at corners. Serifs generally give a more old fashioned or formal feel to a font. The classic serif font is Times Roman.

Serif fonts work well using a Pattern Fill Stitch Type.

Sans Serif

This literally means "without serif". The most well known sans serif font is Arial. Sans serif fonts are generally very clean and usually plain.

Sans serif fonts work well using all Stitch Types.

Cursive

This is used to refer to flowing fonts similar to handwriting. These are generally smooth, but have complex curly details. These are relatively slow to convert to Satin, but only the most complex fonts will give problems.

Stencils

Stencil fonts have the letters broken up into several sections. If you use a stencil font, the separate parts of each letter will be connected with movement stitches.

Multiple Outlines

This can be used for various effects, such as drop shadow, cut out effects, and so on. These types of fonts are generally the most complex and the most likely to produce unexpected results with mySewnet™ QuickFont. Symbol fonts also use multiple outlines for some of their shapes.

Symbol Fonts

A symbol font does not have a standard alphabet and numbers that you would use for text in any language. Instead, symbol fonts allow a variety of shapes to be included in the normal text of a document and treated as normal text. Symbol fonts provide shapes such as bullets, checkmarks, zodiac signs and so on. A well known example is Wingdings.

The shapes in a symbol font may also vary in size within a single font. The size of converted fonts is set by specifying the height of the uppercase letter A, or whichever symbol or character occupies its position in the font. This may affect your converted symbols if the symbol corresponding to the letter A is much smaller or larger than other symbols in the font. If your symbols convert to unexpectedly small or large sizes, compare the symbols by selecting the font in a word processor and typing on your keyboard. Type in A and some other letters to see how the corresponding shapes differ in size from the shape for A.

Alternatively, type in some letters in a normal font then select the letters and change them to the required symbol font.

Symbol fonts work well using Pattern Fill and Outline Stitch Types. Only those characters in a Symbol Font that correspond to the chosen character set are converted.

Overlapping Shapes

Some characters in some fonts are made of overlapping shapes. This is not noticeable when printed, because the solid colors that are used for the fonts hide the overlap. However, this may appear when using Satin Border. This most commonly occurs with K, k and the cedilla character (ç).

Guidelines for Using mySewnet™ QuickFont

The following information gives guidelines for the way you can use each of the styles of font conversion.

Satin

This applies to the Satin Stitch Type.

Size Range: The permitted size range for Satin is 7mm to 50mm, with 12mm to 30mm recommended.

Font Complexity: Satin works best with sans serif fonts of medium weight. The ideal example is Arial, which is a system font installed with the Mac®.

Very complex fonts, such as intricate cursive fonts, can take a long time to convert to satin.

Pattern Fill Areas

This applies to the Pattern Fill and Pattern Fill + Satin Border Stitch Types.

Size: Pattern Fill generally gives better results at larger sizes. This is partly because the fill pattern looks better when it is on a larger area. Also, the definition of the shapes of the characters improves, as there are more stitches used to pick out details of the shapes.

The permitted size range for Pattern Fill is 10mm to 200mm, with 20mm to 120mm recommended. The permitted size range for Pattern Fill + Satin Border is 50mm to 200mm, with 80mm to 120mm recommended.

Satin Alternative: If you have a font that is not converting to Satin very well, then an alternative is to convert the font to a Pattern Fill using Pattern 36. Pattern 36 is a specially designed fill that gives a satin stitch look to a pattern fill area.

Thin Fonts: Fonts that are very thin will not generate a fill area. This is a safeguard against producing very short stitches that might cause problems for an embroidery machine. A simple workaround is to use a Bold version of the font.

Satin Border

This applies to the Pattern Fill + Satin Border, Satin Border and Appliqué Stitch Types.

Size: Satin Border generally gives better results at larger sizes. This is because as the font characters increase in size, the separation between the details is increased, such as the distance between corner points on serifs or other details.

The permitted size range for Satin Border is 50mm to 200mm, with 80mm to 120mm recommended.

Sharp Points: Occasionally, the border will not negotiate a sharp point as well as you might wish. Try changing the font size, or create the font as an Outline instead.

Note: If you have mySewnet™ Embroidery, you may wish to create the font in QuickFont in mySewnet™ Embroidery and then adjust the lettering, before saving ready-prepared lettering to stitch out as an embroidery.

Outline

This applies to the Outline Stitch Type.

Size: The permitted size range for Outline is 25mm to 200mm, with 50mm to 120mm recommended.

Complex Shapes: Outline is effective for complex shapes. For example, it is well suited to symbol fonts.

Use Name Changer to create multiple customized embroideries with varied lettering from a personal template embroidery.

Use Name Changer  to create a series of embroideries with varied lettering automatically from a template that you designed. Use a delimiter to place your text on two different lines.





Note: Use Name Changer to create customized embroideries for a child's clothing, a sports team or company shirt, a wedding place name or hanky, or for a set of labels.

To start Name Changer

- In the Design window  of the Control Panel  click Name Changer .

Using Name Changer

Design a template embroidery with some lettering, then select the piece of lettering to be changed, and use Name Changer  to create multiple versions of this design with varying words. Export the designs as individual embroideries.

Enter the desired names, or paste in a list of names. Then use the Previous  and Next  buttons to view the created designs.



Name List

Type a list of names, or paste in a list from a word processor or spreadsheet.

Note: Your word list will still be available if you re-open Name Changer during the same session.

Line Delimiter

Choose a delimiter to break the text onto two lines. Choose from a Comma, Tab, Space or None.



Note: In the picture above, the space was used as a delimiter to place the names on two lines.

Edit in a New Window

Use Edit in a New Window  to open the selected design in a new window, for example if a frame needs adjusting around a name that is too long, or too short.

Save the edited embroidery from that window.

Previous and Next

Use Previous  and Next  to view the automatically created designs. The Design Information shows the number of stitches and other details for the previewed design.

Design Information

View the design information for the selected design.



Export

Export the complete set of designs.

Note: The design name will be created from the name of your template design, followed by the text for the name concerned.



Create a Template Design for use with Name Changer

First, create the base design for your changing text, and save it as a template. This design uses two SuperDesigns to frame the lettering to be changed. Use a 100 x 100 hoop.

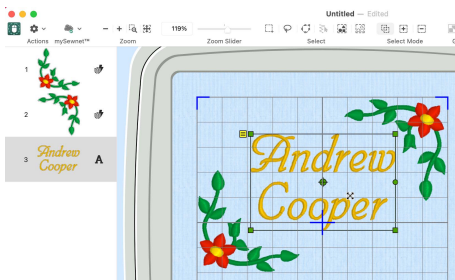
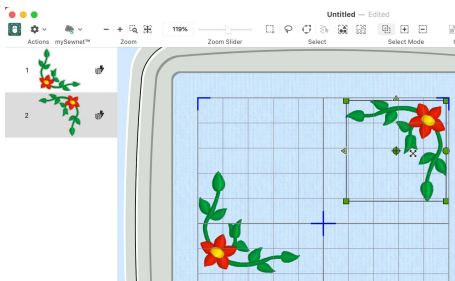
- 1 Open the SuperDesign window .
- 2 Choose the Corners Category from the pop-up menu.
- 3 Select the first design in the Corners Category, and click Apply twice.
- 4 On the upper of the two copies, click the horizontal and vertical flip handles to form the upper part of a frame. Then move the SuperDesign copies to create the frame.
- 5 Open the Letter window .
- 6 Click the displayed font to open the font menu, and enter the word "Nimbus".
- 7 Select the font Nimbus I5-45mm and click OK.
- 8 In the Letters text box, enter the name "Andrew".
- 9 Press Option-Return to start a new line, and then enter "Cooper".
- 10 Press Apply.
- 11 Move the text to between the two parts of your frame.
Note: The two lines of text here can be used as two lines of text in your designs. They could also be used with the Full Circle lettering shape to place text above and below an embroidery.
- 12 Make any other edits to the template, such as matching the design and lettering colors.
- 13 Save your design as "Place Name Template" for future use.



Use your Template Design with Name Changer

- 14 Select the lettering to be changed in your design. Then, in the Design  window click Name Changer .

Note: If the design was Grouped, use Reveal Groups  and then select the lettering.

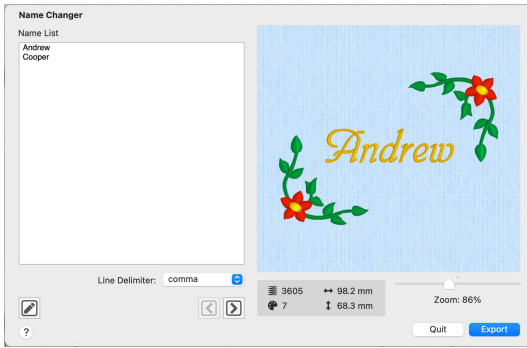



The design as loaded only contains the first name - this is because the second name is used for the second design. Use Line Delimiter to change this.

- 15 In the Line Delimiter popup menu select "space".
- 16 Then, in the Name List place a space after "Andrew", and delete the line break before "Cooper".

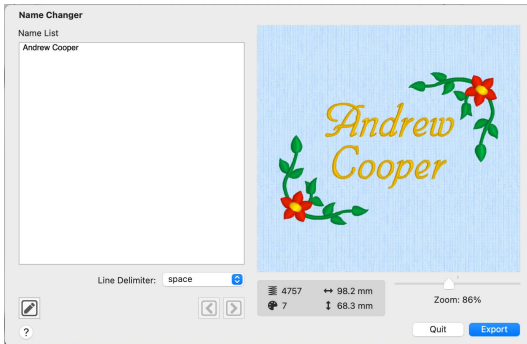

Both names are now shown.

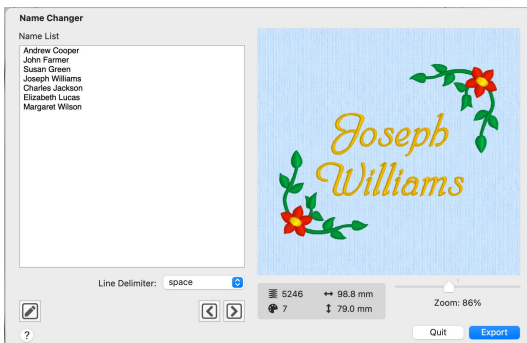

- 17 Enter several more names in the Name List text box, with a space between the two parts of the name.
Note: Use the comma or tab delimiter when pasting in a list of names from a spreadsheet, or a formal word processed document. Also, use a comma to split double barrel names.
- 18 Use the Previous  and Next  buttons to move through the designs.



Note: The design information for each design is shown below the preview.

- 19 If a design does not look right, for example if it touches the frame, click Edit in a New Window , and adjust it in the new mySewnet™ Embroidery window. Then save your adjusted design.
- Note: You can remove the name from your list, or remove the automatically created embroidery from the set of Exported embroideries before you stitch out.
- 20 If several embroideries look wrong, close Name Changer and adjust your template so that the names will fit better. Save the template, then open Name Changer again.
- 21 When you are happy with your automatically created set of embroideries, click Export. See “Export” on page 33.
- 22 In the Export dialog box, choose your file format (for example .vp3) and then click OK. The Save As dialog box is displayed.
- 23 In the Save As dialog the name of your template design is shown - here "Place Name Template". Shorten the name, for example to "Place Name", as the name in your list will be added to that design's name.
- 24 Click Save to generate the designs, one for each name.
- 25 Use the Finder to check that the designs have been created, and to look at them.
- 26 Before closing down mySewnet™ Embroidery, open Name Changer again.
- 27 Select your list of names, then use Command-C to copy it. Close Name Changer.
- 28 Select the lettering in your template embroidery, and ensure that Notes  is selected in the Design Panel.
- 29 Click Edit , then paste the list of names into the Notes (Command-V). Click OK to close the Notes.
- Note: Reopen the template file and add more names, or use a completely different set of names with that template for a different collection of designs.
- 30 Save the template embroidery with your list of names.

Note: You can use the Alignment tools to place the embroideries together in a large hoop for stitching out together on non-fraying fabric, then trim as desired.

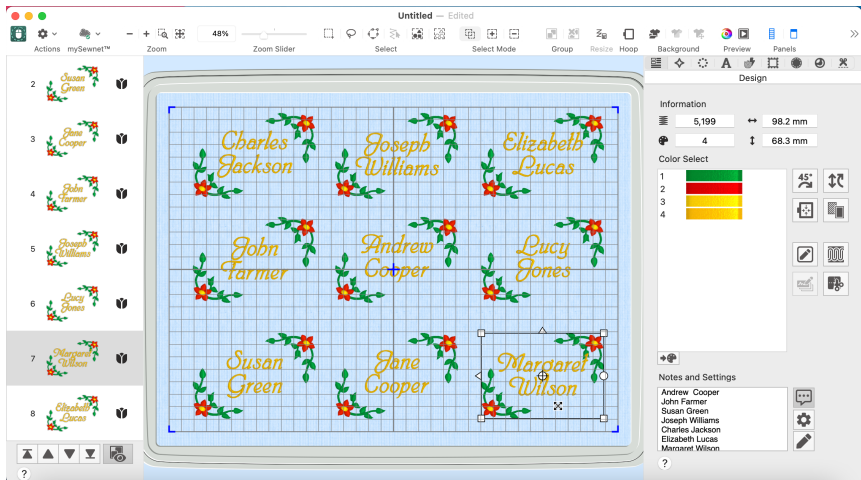

This chapter describes how you can use the SuperDesigns available in mySewnet™ Embroidery to enhance your embroidery project.

Create SuperDesigns from the SuperDesign sets available in mySewnet™ Embroidery. SuperDesigns are special designs that can be resized with constant stitch density.

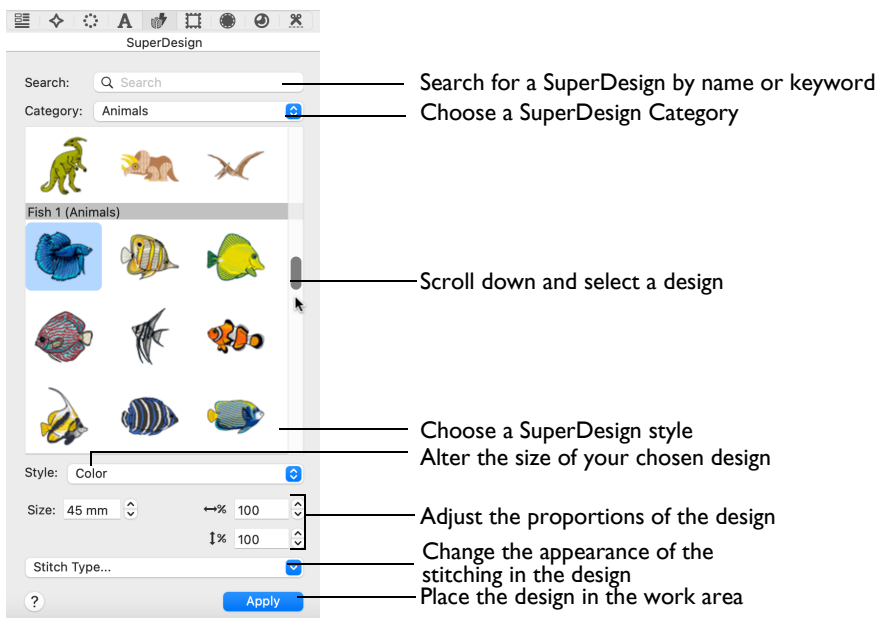

Some SuperDesigns are multicolored, and the stitch type for many can be changed. Alter the size, proportions, stitch type and thread color. A SuperDesign can be resized with constant stitch density, and the stitch properties adjusted, until it is fixed as embroidery.



To Open the SuperDesigns Window

- Click Control Panel , then click SuperDesign .

To learn how to	Go to
Create a SuperDesign	See “Create a SuperDesign” on page 439.
Change the shape of a SuperDesign	See “Reshaping a SuperDesign” on page 441.
Change the properties for an existing design	See “Changing SuperDesign Properties” on page 442.

To learn how to	Go to
Change the color of a SuperDesign	See “Change SuperDesign Color” on page 443.
Fix a SuperDesign as an embroidery	See “Fixing SuperDesigns as Embroideries” on page 443.
Create a SuperDesign circle with Encore	See “Create a SuperDesign Daisy Chain” on page 444.

Create a SuperDesign

- 1 Open the SuperDesign window .
- 2 Choose a SuperDesign Category from the pop-up menu.
The preview shows the first design set in that category.
Note: Choose a single Category, or browse All Categories.
- 3 Scroll down to select a SuperDesign set.
- 4 Click a design to select it.
- 5 Choose a SuperDesign Style (for instance, Color or Line).
- 6 Set the Size in millimeters as desired, from 5mm to 200mm. This sets the height of the SuperDesign, and the width is set proportionally.
- 7 Click the arrows for width % and height % to change the proportions of the design.
Alternatively, enter a size in the number box.
- 8 If desired, select a line or fill type from the Stitch Type pop-up menu, then click the stitch type to open the properties dialog for the stitch type. See “Choosing Stitch Properties” on page 462.
- 9 Change the stitch properties for the SuperDesign in the properties dialog, for example the density, and the stitch length, angle and pattern. Click OK to close the dialog.
- 10 Click Apply. The SuperDesign appears in the work area, leaving any existing SuperDesigns unchanged.

About SuperDesigns

SuperDesigns are created from the SuperDesign sets available in mySewnet™ Embroidery.

SuperDesign sets are grouped into Categories. Each set contains 9 SuperDesigns. The SuperDesign window shows thumbnails of all the SuperDesigns in the currently selected SuperDesign Category.

To Select a SuperDesign Set

- In the SuperDesign window choose a Category from the pop-up menu. Then scroll down and choose a SuperDesign set.

SuperDesign Category

There are 29 SuperDesign Categories: Animals, Appliqué, Borders, Buttonholes, Cartoons, Celebrations, ChildStyle, Corners, Effects, Encore, Fantasy, Flowers and Leaves, Food and Drink, Hearts, Holidays, Home, Music, People, Redwork, Religious, Scallop, Sports, Sports Symbols, Stars, Tassels, Trees, Wreath and Zodiac.

SuperDesign Set

Each SuperDesign category contains numbered SuperDesign sets. Each set contains 9 SuperDesigns.

A set of SuperDesigns has its own default size. This size is used each time the SuperDesign set is first selected.

SuperDesign Size

SuperDesign size can be set from 5mm to 200mm. This is the height of the SuperDesign.

If you set a satin SuperDesign to a very large size, use Satin Properties to choose a pattern which will prevent loose stitching that may catch and pull easily. See “Satin Column” on page 494.

Once a SuperDesign has been converted to an embroidery it can only be scaled and resized in the same way as any other embroidery. If further adjustments are required, place the design again as a new SuperDesign.

Height and Width

Adjust height ↑% and width ↔% separately to change the proportions of the SuperDesign. For instance, increase height to make the design taller without increasing the width.

Height and width can be set from 25% to 400% of the original size, in steps of 1%. The properties stay the same until you change them or close mySewnet™ Embroidery.

To Set SuperDesign Dimensions

- In the SuperDesign window, click the Size up and down arrows or enter a number to change the design size.
- In the SuperDesign window, enter a number in the height or width number box, or use the arrows to adjust the height or width.
- When a SuperDesign has been placed in the work area, you can resize it using SuperDesign Properties. See “Changing SuperDesign Properties” on page 442.
- In the work area, use the handles on the selection box to resize the design.

Stitch Type

Use Stitch Type to alter the appearance of the stitching used in the selected SuperDesign.

Note: If there is more than one stitch area of a particular type in the design, the pop-up menu will show that stitch type in a numbered list; for example Pattern Fill 1, Pattern Fill 2.

Changes made to the stitch properties for a SuperDesign set are retained until a new SuperDesign set is selected.

To change the Stitch Type

- Select a stitch type from the pop-up menu with the ellipsis (three dots) to open the properties dialog for the stitch type. See “Choosing Stitch Properties” on page 462.

Edit SuperDesigns

You can adjust SuperDesigns after they have placed in the work area, but before they have been fixed as an embroidery.

Note: A SuperDesign that has not been fixed as an embroidery has green handles. A SuperDesign fixed as an embroidery has white handles or blue handles. See “Resize and Scale” on page 96.

To Adjust SuperDesigns

- Drag the green handles to change the shape of a SuperDesign. Hold the Shift key while dragging to retain the original proportions. Hold the Option key to resize from the center. See “Reshaping a SuperDesign” on page 441.
- Control-click a SuperDesign and select an option from the context menu:
 - Choose Properties to change the size, height and width. See “Changing SuperDesign Properties” on page 442.
 - Choose a stitch type and open its properties dialog to alter properties such as density, stitch length, angle and pattern. See “Choosing Stitch Properties” on page 462.
- To change the thread colors in the SuperDesign, in the Control Panel click Design, then click a thread color. See “Changing a Thread Color” on page 79.
- Fix the SuperDesign as an embroidery. See “Fixing SuperDesigns as Embroideries” on page 443.

Reshaping a SuperDesign

- 1 Choose a SuperDesign in the SuperDesign window. See “Create a SuperDesign” on page 439.
- 2 Click Apply. The SuperDesign appears in the work area.
- 3 Drag the design a short distance to the right. A four arrow pointer appears as you drag.
- 4 Place the pointer over one of the square green handles at the corners of the design. The Adjust/resize pointer  appears.
- 5 Drag the handle to change the shape of the SuperDesign.
- 6 Hold the Shift key and drag one of the handles. The size changes, but the shape remains the same. (Hold the Option key to resize from the center.)
- 7 Use the round handle on the right to rotate the SuperDesign. The handles on the design are now white or blue. This means that the SuperDesign has been fixed as an embroidery.
- 8 Undo the rotation. The green handles reappear. You can adjust the design again.

SuperDesign Properties

Use the SuperDesign properties dialog to change the SuperDesign size, width, height and angle of a design that has been placed on the work area.

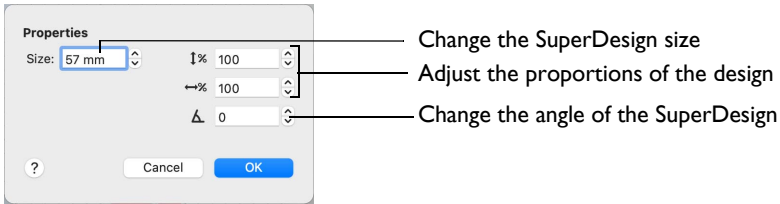

To change SuperDesigns before you have clicked Apply, use the SuperDesign window. See “Create a SuperDesign” on page 439.

Note: SuperDesign properties may not be changed once the design has been converted to embroidery.

To open SuperDesign Properties

- In the work area, Control-click the SuperDesign, and select Properties from the context menu.

Note: You must Control-click directly on the design. If you click outside the design, a different context menu will appear.

Size

SuperDesign size can be set from 5mm to 200mm. This is the height of the SuperDesign.

Height and Width

Use height ↑% and width ↔% to adjust the proportions of the SuperDesign. For instance, to make the design taller without increasing the width, increase the height.

Height and width can be set from 25% to 400% of the original size, in steps of 1%.

Rotation

Use Angle to rotate the SuperDesign to the desired angle.

Changing SuperDesign Properties

Use the SuperDesign properties dialog to change a design after it has been placed, but before it has been fixed as an embroidery.



Note: You cannot change the design with SuperDesign Properties. Create a new design instead. To change the stitch type or appliqué, Control-click the SuperDesign and select the stitch type from the context menu. See “Stitch Type” on page 462.

- 1 Control-click within the SuperDesign and select Properties from the context menu. The SuperDesign properties dialog appears.
- 2 Adjust Size to change the basic size of the SuperDesign. It is recommended to use a size within the range suggested in the SuperDesign guide.
Note: Each set of SuperDesigns has its own default size. The default size is set automatically each time a SuperDesign set is selected.
- 3 Click the arrows for percentage width $\leftrightarrow\%$ and height $\updownarrow\%$ to change the proportions of the SuperDesign. Alternatively, enter a size in the number box.
- 4 Enter a number in the rotation angle number box, or use the arrows to increase or decrease the angle of rotation of the SuperDesign.
- 5 Click OK to apply your changes to the selected SuperDesign.

SuperDesign Color

You can change the colors of SuperDesigns before or after they have been fixed as embroideries.

Change SuperDesign Color

- 1 Open the SuperDesign window  and choose "Borders" from the SuperDesign Category pop-up menu. The Borders | SuperDesign set appears.
- 2 Click the design in row 3 column 3 and click Apply.
- 3 In the Control Panel, click Design . The Design window appears. The thread colors for the SuperDesign can be seen in the Color Select area.

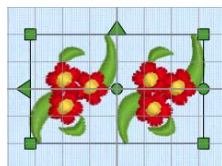

- 4 Click the top color in the list. The Color Selection dialog opens. See “Color Selection Dialog” on page 79 for more information.

- 5 Change this pale green to a deeper green.

- 6 Click OK to close the dialog. The green has changed in the Design window and in the SuperDesign in the work area.

- 7 Undo the color change. The SuperDesign has returned to its original colors.

Note: If you have many of the same SuperDesigns, it is recommended to Combine and ColorSort and then change the colors.

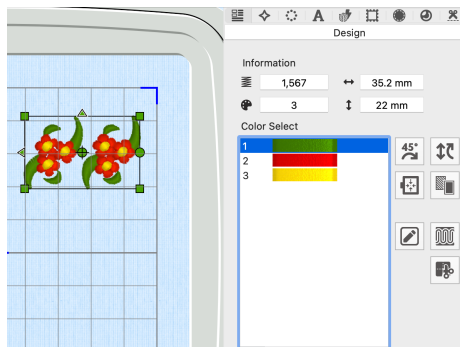

Fixing SuperDesigns as Embroideries

SuperDesigns are fixed as an embroidery when they are Combined with another design, or when Fix as Stitches is used. See “Fix as Stitches” on page 30.

If a SuperDesign is selected when opening the Modify  window it will be fixed. The stitches are then created, and any further resizing of the embroidery may affect stitch density and length. The stitch properties, for example the density, pattern, angle or stitch length, may not be changed after it is fixed.



Note: When SuperDesigns are fixed as embroideries, the handles change from green to white or blue. After a SuperDesign has been converted to embroidery, it can no longer be changed with SuperDesign properties.

To Reverse Fixing as an Embroidery

- Control-click and select Undo from the context menu. This will preserve any adjustments made with the selection box handles.

Create a SuperDesign Daisy Chain

Use Encore to create a circle of SuperDesigns.

- 1 Open the SuperDesign window .
- 2 Choose "Borders" from the SuperDesign Category pop-up menu. The Borders SuperDesign sets are shown.
- 3 In the Borders 1 set, click the flower design in row 1 column 3 (number 3).
- 4 Ensure that Size is set to 20mm.
- 5 Click Apply and the flower SuperDesign appears on the work area.
- 6 In the Control Panel, click Encore . The Encore window appears. See "Encore" on page 103.
- 7 Ensure that the Encore Type is set to Circle .
- 8 Ensure that Position is set to Standard FFF.
- 9 Set Repeats to 6.
- 10 Ensure that Group is selected.
- 11 Click Preview and a circle of daisy designs appears on the work area.
The daisy designs appear a little sparse. More designs would create a better circle.

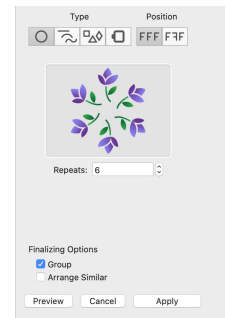
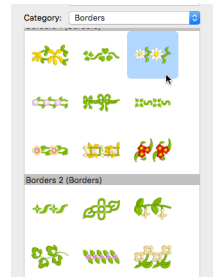

- 12 Increase the number of Repeats to 10 and click Preview again. The circle now looks more balanced.
- 13 Drag the top of the circle downwards until the daisy designs meet.
- 14 Click Apply. The daisy design is now surrounded by a selection box with a solid line (a group). The individual SuperDesigns can be seen within this group.
- 15 In the Control Panel, click Design. The colors for the individual SuperDesigns have been kept. Use ColorSort when Exporting to minimize the number of colors when stitching out. The minimum number of colors will be 3, if none of the designs overlap. Your ring may have more colors, depending on the amount that the flowers overlap.

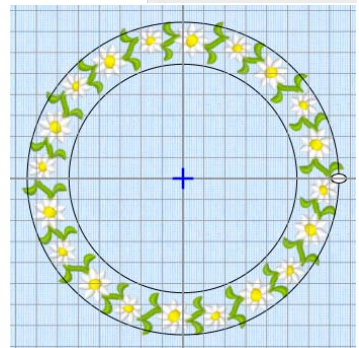

This chapter describes how you can use the frames, flourishes, borders and motif underlines in mySewnet™ Embroidery to enhance a design or lettering, or to create individual frames, borders, motif underlines and individual motifs.

In the Frames window you can create a frame or border which is placed at a size to fit around the currently selected embroidery, lettering or SuperDesign, or if no embroidery is selected, on the work area at a chosen size. You can also create flourishes above and below, or motif underlines below the selected embroidery, or separately from an embroidery, or place single motifs.

Creating Frames, Borders and Underlines

In the Frame window you can select corners, frames, side pieces, flourishes, borders and motif underlines to place around your embroidery.

Choose corners, frames, side pieces, flourishes, a border or an underline

Scroll down and choose a design for your frame

Crop your embroidery, or select Margin and set its size

Group the embroidery and the frame

Change the appearance of the stitching in the frame

Place the frame around your embroidery

Note: In this chapter, corners, flourishes, frames and side pieces are referred to collectively as frames.

Choose from the categories of corners, frames and side pieces. Then choose a frame set, and select a design. Place the frame around your embroidery, or anywhere on the work area.

Alternatively, select Flourish and choose a flourish to be placed above, below or as a duo above and below the selected embroideries.

Some frames are multicolored, and the stitch type for many can be changed. A frame can be resized with constant stitch density, and the stitch properties adjusted, until it is fixed as embroidery.

Note: If multiple embroideries are surrounded by a frame with the Crop option selected, the inner embroideries will be combined automatically.





The Frame and Flourish options stay the same until you change them, or close mySewnet™ Embroidery.

To Open the Frame Window

- Click Control Panel , then click Frame .







To learn how to	Go to
Create a frame	See “Create a Frame” on page 446.
Create a flourish	See “Create a Flourish” on page 447.
Change the shape of a frame	See “Reshaping a Frame” on page 451.
Change the size of a frame	See “Changing Frame Properties” on page 452.
Change the color of the frame	See “Change Frame Color” on page 453.
Place a frame around an embroidery	See “Grapes and Birds in a Frame” on page 454.
Use appliqué with frames	See “Stitching out an Appliqué Frame” on page 447.
Place a border around a design	See “Create a Border” on page 457.
Create a motif underline	See “Create Lines of Butterfly Motifs” on page 460.
Place a single motif	See “Create a Single Motif” on page 459.

Create a Frame

- 1 Load an embroidery in the work area and select it.
- 2 Open the Frame  window.
- 3 Select a frame Type (corners , frames  or side pieces ).
The preview shows the first frame set of that type and its name.
- 4 Scroll down to choose a frame set.
- 5 Click a frame to select it.
- 6 If desired, select Group to keep the frame with the embroidery.
- 7 Select to use a margin or to crop the embroidery when placing the frame.
Margin leaves a space between the embroidery and the frame around it. Crop leaves no margin visible, and will cut the embroidery to the shape of the frame.
Note: It is recommended to use the Group option when Crop is selected.
- 8 If you selected Margin, set the Size in millimeters from -50 mm to 50 mm.
- 9 If desired, select a line or fill type, or appliqué, from the pop-up menu to open the properties dialog for the stitch type. See “Choosing Stitch Properties” on page 462.

- 10 Change the stitch or appliqué properties for the frame in the properties dialog, for example the density, and the stitch length, angle and pattern. Click OK to close the dialog.
Note: When one or more embroideries are selected, the frame is placed around that selection.
- 11 Click Apply in the Frame window to view your framed embroidery.

Create a Flourish

- 1 Load an embroidery in the work area and select it.
- 2 Open the Frame  window.
- 3 Select Flourishes .
The preview shows the first flourish set and its name.
- 4 Scroll down to choose a flourish set.
- 5 Click a flourish to select it.
- 6 Select whether to place the flourish Above , Below , or as a Duo  above and below the embroidery.
- 7 Set the Size of the Margin in millimeters from -50mm to 50mm.
Note: If a negative margin is used the flourish may overlap the embroidery.
- 8 Set the percentage width % relative to the size of the embroidery.
- 9 If desired, select Group to keep the flourish with the embroidery.
- 10 If desired, select a line or fill type, or appliqué, from the pop-up menu to open the properties dialog for the stitch type. See “Choosing Stitch Properties” on page 462.
- 11 Change the stitch or appliqué properties for the flourish in the properties dialog, for example the density, and the stitch length, angle and pattern. Click OK to close the dialog.
Note: When one or more embroideries is selected, the flourish is placed above or below that selection.
- 12 Click Apply to view the finished result.

Appliqué Frames and Foam Frames

For appliqué fonts, SuperDesigns and frames, the fabric can be changed as well as some of the border settings. For example, in Stitch Type select Appliqué Fabric, and in the Appliqué Selection dialog change the fabric, angle and margin. See “Appliqué Selection” on page 195. The appliqué placement stitches cannot be edited, but the position of the placement line may be adjusted to match the appliqué piece margin.

Note: The position of the pattern in an appliqué fabric may only be changed after fixing as stitches.

For Foam fonts and frames, only the color can be changed. The Stitch Type area is unavailable, and no properties can be selected in the Context menu.

Special instructions are displayed for stitching out appliqué or foam fonts, SuperDesigns and frames. The instructions can be previewed in the Design Player.

Stitching out an Appliqué Frame

Appliqué frames are designed to be stitched out in a particular sequence. They are created with the standard appliqué options, to trim on the machine. Preview the

two stops in the Design Player, with instructions to place the fabric and to trim it. These instructions are also present on the printed worksheet.

Note: If you are using pre-cut pieces (with outlines created in Export Appliqué Pieces for a fabric cutter or INSPIRA® Cutwork Needles), the second stop can be ignored as there is no need to trim. It may also be useful to match the placement line to the appliqué piece margin, to ensure the placement line is visible.

When stitching out an appliqué embroidery, do as follows:

- 1 Begin embroidering. A running line will show where to position the appliqué fabric.
- 2 A stop then allows you to place the fabric. The message "Place the appliqué fabric now" is displayed.
- 3 Stitch down the appliqué fabric with double stitch.
- 4 The machine stops again, and the message "Cut around the appliqué" is displayed. Trim the fabric.

Note: If desired, you can change the color to that for the first color of the embroidery.

- 5 Finally, finish the edges with the satin or motif line.

Note: The placement section in the appliqué is the same color as the first color in the frame, so it doesn't show under the appliqué fabric. If desired, change in mySewnet™ Embroidery to the first color for the embroidery.

Stitching out a Foam Frame

Foam frames are designed to be stitched out in a particular sequence. Preview the two stops in the Design Player, with instructions to place the foam and to remove any excess foam. These instructions are also present on the printed worksheet.

When stitching out a puffy foam frame, do as follows:

- 1 Begin embroidering. A running line will show where to position the puffy foam.
- 2 A stop then allows you to place the foam. The message "Place the puffy foam on the fabric now" is displayed.
- 3 Stitch down the foam with satin stitching.
- 4 The machine stops again, and the message "Remove any excess puffy foam" is displayed. Remove the excess foam.

The thread color is changed, and the framed design is stitched.

Frame Selection

Frames, corners, flourishes or side pieces are placed around the currently selected embroideries, or placed at a default size on the work area.

To Select a Frame Set

- In the Frame window select a frame Type. Then scroll down and choose a frame set.

Frame Type

There are four frame Types: corners , flourishes , frames  or side pieces .

Note: In this chapter these frame types are referred to collectively as frames.

Frame Set

Each frame type contains several named frame sets.

Corners, frames and flourishes are available in three styles: square, portrait and landscape.

Frame Options

The frame is placed at a size to fit around the selected embroidery. If there is no selected embroidery, the frame default size is used.

Margin

Margin leaves a space between the embroidery and the frame around it.

- Click the arrows to set Frame margin from -50mm to 50mm.

Crop

Crop the embroidery when placing the frame, so that no margin is visible. If required, the embroidery will be cut to fit the shape of the frame.

For example, a circular frame will crop a rectangular embroidery to a circle, with no visible margins. If the original embroidery is portrait shaped, it is recommended to use the portrait style frame.

Group

Group the frame with the embroidery when it is placed on the work area.

Note: Group should usually be selected, particularly when Crop is used. If Group is not selected, the frame can be moved separately. Deselect Group if you want to move the frame after placing it. Use Reveal Groups  when changing stitch properties in a grouped embroidery or frame.

Flourish Options

The flourish is placed at a size to suit the selected embroidery. If there is no selected embroidery (or more than one selected embroidery), the flourish default size is used.

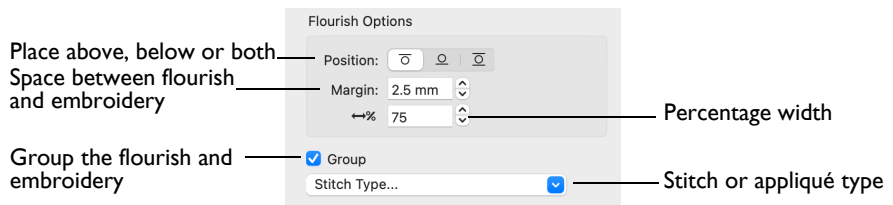

Position

Above ☐ : Place the flourish above the selected embroidery (or embroideries).

Below ☐ : Place the flourish below the selected embroidery (or embroideries).

Duo ☐ : Place vertically mirrored flourishes above and below the selected embroidery (or embroideries).

Margin

Margin leaves a space between the embroidery and the flourish.

- Click the arrows to set Flourish margin from -50mm to 50mm.

Percent Width

Adjust width $\leftrightarrow\%$ to change the size of the flourish.

Percent width can be set from 10% to 200% of the original size, in steps of 1%. The properties stay the same until you change them or close mySewnet™ Embroidery.

Group

Group the flourish with the embroidery when it is placed on the work area.

Note: Group should usually be selected. If Group is not selected, the flourish can be moved separately. Deselect Group if you want to move the flourish after placing it. Use Reveal Groups  when changing stitch properties in a grouped embroidery or flourish.

Stitch Type

Use Stitch Type to alter the appearance of the stitching or appliqué used in the frame.

Note: If the Stitch Type area is dimmed, this means that the frame was designed with properties that cannot be edited. This is usually because the properties vary within the frame set.

Changes made to the stitch properties for a frame set are retained until a new frame set is selected.

To change the Stitch Type

- Select a stitch type or appliqué from the pop-up menu to open the properties dialog for the stitch type. See “Choosing Stitch Properties” on page 462.

Apply

Click Apply to place the frame around the selected embroidery, or on the work area if no embroidery is selected.

Edit Frames

You can adjust frames after they have been placed in the work area, but before they have been fixed as an embroidery.

Note: A frame that has not been fixed as an embroidery has green handles. A group has orange handles. A frame fixed as an embroidery has white or blue handles.

To Adjust Frames

Note: Use Reveal Groups  to select a frame that is grouped with an embroidery. See “Reveal Groups” on page 93.

- Drag the green handles to change the shape of a frame. Hold the Shift key while dragging to retain the original proportions. Hold the Option key to resize from the center. See “Reshaping a Frame” on page 451.
- Control-click a frame and select an option from the context menu:
 - Choose Properties to change the size, height and width. See “Changing Frame Properties” on page 452.
 - Choose a stitch type and open its properties dialog to alter properties such as density, stitch length, angle and pattern. See “Choosing Stitch Properties” on page 462.
- To change the thread colors in the frame, in the Control Panel click Design, then click a thread color. See “Changing a Thread Color” on page 79.
- Fix the frame as an embroidery. See “Fixing Frames and Flourishes as Embroideries” on page 453.

Reshaping a Frame

- 1 Create a frame in the Frame window. See “Create a Frame” on page 446.
- 2 Click Apply. The frame appears in the work area.

Note: If Group was selected when creating the frame, use Reveal Groups  to adjust the frame separately from the embroidery. See “Reveal Groups” on page 93.

- 3 Drag the frame a short distance to the right. A four arrow pointer appears as you drag.
- 4 Place the pointer over one of the square green handles at the corners of the frame. The Adjust/resize pointer  appears.
- 5 Drag the handle to change the shape of the frame.
- 6 Hold the Shift key and drag one of the handles. The size changes, but the shape remains the same. (Hold the Option key to resize from the center.)
- 7 Use the round handle on the right to rotate the frame, then Undo the rotation.
- 8 Click Reveal Groups to finish editing the frame separately.

Frame Properties

Use the Frame or Flourish properties dialog to change the size, and the percentage width ↔% and height ↓% of a frame that has been placed on the work area.

Note: Changes made in the Frame properties dialog will undo any adjustments made using the selection box handles.

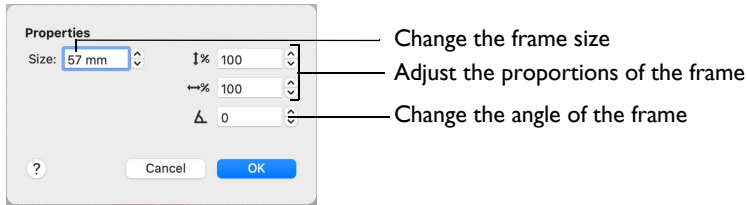

To change a frame before you click Apply, use the Frame Options dialog.

Note: Frame properties may not be changed once the design has been converted to embroidery, for example if Fix as Stitches has been used.

To open Frame Properties

- In the work area, Control-click the frame, and select Properties from the context menu.

Note: You must Control-click directly on the frame. If you click outside the frame, a different context menu will appear.

Size

Frame size can be set from 5mm to 200mm. This is the height of the frame.

Height and Width

Use Height ↓% and Width ↔% to adjust the proportions of the frame. For instance, to make the frame taller without increasing the width, increase the height.

Height and width can be set from 25% to 400% of the original size, in steps of 1%.

Rotation

Rotate the frame to the desired angle.

Changing Frame Properties

Use the Frame properties dialog to change a frame after it has been placed, but before it has been fixed as an embroidery.

Note: You cannot change the frame with Frame properties. Create a new frame instead. To change the stitch type or appliqué, Control-click the frame and select it from the context menu. See “Stitch Type” on page 462.

- 1 Control-click within the frame and select Properties from the context menu. The Frame properties dialog appears.
- 2 Adjust Size to change the basic size of the frame.

- 3 Click the arrows for height and width to change the proportions of the frame. Alternatively, enter a size in the number box.
- 4 Click OK to apply your changes to the selected frame.

Frame Color

You can change the colors of frames before or after they have been fixed as embroideries.

Change Frame Color

- 1 Load an embroidery in the work area and select it.
- 2 Open the Frame window  and choose "Frames".
- 3 Scroll down until you see Classical 6 MC.
- 4 Click the design in row 1 column 1.
- 5 Ensure that Margin is selected, and click Apply.
- 6 In the Control Panel, click Design. The Design window appears.
The thread colors for the frame can be seen in the Color Select area.
- 7 Click the top color in the list. The Color Selection dialog opens. See "Color Selection Dialog" on page 79 for more information.
- 8 Change this deep yellow to a pale yellow.
- 9 Click OK to close the dialog.
The yellow has changed in the Design window and in the frame in the work area.
- 10 Undo the color change. The frame has gone back to its original colors.

Fixing Frames and Flourishes as Embroideries

Frames and flourishes are fixed as an embroidery when they are Combined with another design, or when Fix as Stitches is used. See "Fix as Stitches" on page 30.

If a frame or flourish is selected when opening the Modify  window, it will be fixed. The stitches are then created, and any further resizing or rescaling of the embroidery will affect stitch density and length. The stitch properties, for example the density, pattern, angle or stitch length, may not be changed after it is fixed.

Note: When frames are fixed as embroideries, the handles change from green to white or blue. After a frame has been converted to embroidery, it can no longer be changed with Frame properties.

To Reverse Fixing as an Embroidery



- Control-click and select Undo from the context menu. This will preserve any adjustments made with the selection box handles.
- Your most recent settings will still be in the Frame window. Click Apply to recreate the frame.

Frames Examples

Frame one or more embroideries, or use a frame with appliqué.

Grapes and Birds in a Frame

Frame an embroidery and change the frame properties.

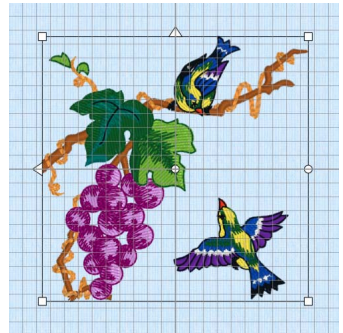

- 1 Choose File > Insert. See “Insert” on page 25.
- 2 Browse to mySewnet/Samples/Embroidery/Stitch.
- 3 Scroll down to "Grapes and Birds.vp4".
Note: If the viewer is set to Icons Only, hover the pointer over a design thumbnail to view its name.
- 4 Click to load the embroidery into the work area. The embroidery has white or blue handles on its selection box, depending on the Resize  mode.
- 5 Open the Frame window , and in Type select Corners .
- 6 Scroll down the Corners window to Ornamental 2 MC, and click the corners in row 1, column 1. These corners are designed to frame a square embroidery. The corners in rows 2 and 3 are for portrait and landscape formats.
- 7 In Surround, select Margin and ensure that it is set to 2.5 mm. (This is the default size.)



- 8 Deselect Group.
- 9 Click Apply. The set of corners is placed around the embroidery as a frame. It has green handles.
- 10 Drag the frame a short distance. It moves separately from the embroidery. If the embroidery moves with the frame, Group was selected. Group treats the embroidery and frame as a unit. If Group is not selected, the frame can be immediately nudged into place. Only deselect Group when you want to move the frame after placing it.













- Note:* If you grouped the embroidery and frame, use Reveal Groups to adjust them separately.
- 11 The frame would look better if it fitted a little more snugly. Delete the frame.
 - 12 In the Frame window, click the down arrow to change Margin to 0.5 mm.
 - 13 Ensure the design is selected, then click Apply. The frame now fits closely around the embroidery, but does not overlap it. The satin line on the outside of the corners is a little heavy. Its width can be changed.
 - 14 Control-click the frame and select Satin Line from the context menu. The Satin Line properties dialog appears. See “Satin Line” on page 504. Alternatively, you could have used Stitch Type to change the satin properties before placing the frame.



- 15 In the Satin Line properties dialog, click the down arrow to change Width to 2.5 mm.
- 16 Click OK. The frame is now more delicate.
- 17 Click outside the frame to view the design without the selection box.
Alternatively, click Realistic 3D mode  or Life View  to see the design without the selection box and grid.
- 18 To keep the embroidery and frame together as a unit, select both and in the toolbar click Group .
Note: To merge the embroidery with the frame, fixed as stitches, choose Design > Combine All.

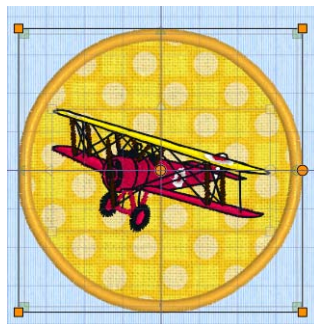
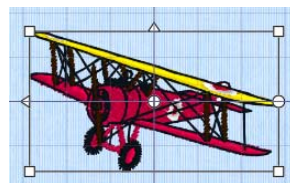

Create a Framed Badge: Champion Dad

- 1 Click Hoop  and in the Hoop Selection dialog select 180mm x 130mm - Universal Large Hoop 1.
- 2 Set Orientation to Natural and click OK.
- 3 Choose File > Insert.
- 4 Browse to mySewnet/Samples/Embroidery/Stitch.
- 5 Scroll down until you see "Biplane", and click to select it.
- 6 Click Open to load the embroidery into the work area.
Note: The embroidery has white handles on its selection box, showing that it is initially in Scale rather than Resize  mode (blue handles).
- 7 Open the Frame window  of the Control Panel , and in Type select Frames .
- 8 Select the second (round) frame in Applique Shields 1 (the top set in the list).
- 9 In the Stitch Type pop-up menu select Appliqué Fabric to view the Appliqué Selection dialog.
- 10 Click Load Previously Saved Fabric . The Picture Viewer opens.
- 11 Browse to the folder General/Checkerboard.
- 12 Scroll down and select the fabric Checkers Round 1 - 18, then click OK to close the viewer.
- 13 Click OK to close the Appliqué Selection dialog.
- 14 Ensure that the embroidery is still selected and click Apply to place the frame around the embroidery.
- 15 Open the Design window  of the Control Panel .
- 16 In the Color Select area, Control-click the top color in the list. This is the blue for the frame.
- 17 Click Colors  to open the Colors window and select the Colored Pencils .
- 18 Click the Cantaloupe color pencil on the bottom row.
- 19 Click OK to close the Color Selection dialog. The frame border is now a gold color.
- 20 Open the Letter window .



- 21 Click the displayed font in the Letter window, and in the Font Viewer enter the word "Carlton" in the Search box.
- 22 Click OK to select the font Carlton UC 15-45mm.
- 23 Enter the word "Champion" in the Letters text box.
- 24 Press Option-Return for a new line and in the line below enter the word "Dad".
- 25 Set Gap to 10.
- 26 Click the current Lettering Shape, and in the pop-up menu, select Full Circle .
- 27 Ensure that ColorSort is selected (checked).
- 28 Click Apply. The lettering appears around the embroidery. Its handles are green.
Note: If the lettering does not surround the embroidery, the embroidery was not selected. Choose Edit > Undo, click to select the embroidery, then click Apply again.
- 29 Drag the square green handle at the top of the circle of lettering downwards so that it fits well around the framed embroidery.
- 30 Click Design Player  to view the embroidery as it will be stitched out.
- 31 Click Close to close the Design Player.
- 32 Choose File > Save and save the embroidery as "Champion Dad".
Note: The various parts of this multipart embroidery will be stored separately, making further adjustment easier.



Creating Borders

Use the Border Options  to create a border to place around your embroidery.

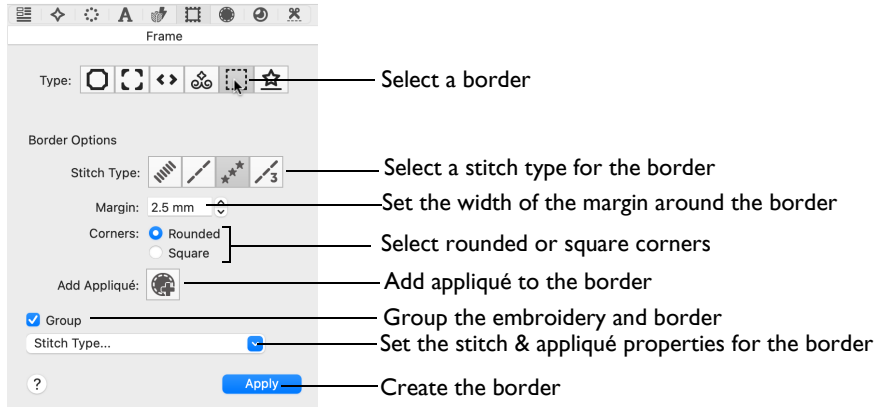

Select a border type, then set the margin width, and select rounded or square corners. Use Stitch Options to set the properties for each stitch type and for appliqué.



Note: The stitch properties may only be adjusted before the border is created.

The border is placed around the rectangular "edge" of the currently selected embroidery, or around the inside edge of the hoop. (In the ExpressMonogram Assistant, the border is placed around the edge of the envelope area.)

Note: If more than one embroidery is selected, the border is placed around the selected embroideries. If no embroidery is selected, the border is placed around the inside edge of the hoop.

The border is placed with white handles or blue handles, depending on the Resize  mode.

Create a Border

- 1 Load an embroidery in the work area and select it.
- 2 Open the Frame  window.
- 3 In Type, select Border .
- 4 Select a Stitch Type (Satin Line, Triple Stitch, Running Stitch or Motif Line).
- 5 If desired, click Options to open the properties dialog for the stitch type. See "Choosing Stitch Properties" on page 462.
- 6 Change the stitch properties for the border in the properties dialog, for example the density and stitch length. Click OK to close the dialog.



- 7 If desired, click Add appliqué  to place an appliqué piece behind the embroidery and border. Use Appliqué Fabric and Appliqué Options in the Stitch Type popup menu to set appliqué type and to choose a fabric. See “Appliqué Selection” on page 195.
- 8 Set the Margin size in millimeters from -50 mm to 50 mm.
Note: For a satin or motif border you may need to adjust the margin to avoid overlapping the embroidery.
- 9 Select Rounded or Square corners.
Rounded corners may overlap the corners of the embroidery. Adjust the Margin for the desired effect.
- 10 If desired, select Group to keep the border and the embroidery as a unit.
- 11 Click Apply in the Border window to view your framed embroidery.

Stitch Types

Use Stitch Type to select the appearance of the stitching used in the border. The stitch types available for automatically created borders are:

- Satin Line 
- Triple Stitch 
- Running Stitch 
- Motif Line 

- Click Stitch Options to set the properties for a stitch type. The properties dialog for that stitch type will open. See “Choosing Stitch Properties” on page 462.

For the individual stitch types, see “Satin Line” on page 504, “Triple Stitch” on page 503, “Running Stitch” on page 501 and “Motif Line” on page 506.

Appliqué

In Appliqué, use Add Appliqué  to create an appliqué piece to place behind the embroidery and border. Use Appliqué Fabric and Appliqué Options in the Stitch Type popup menu to set appliqué type and to choose a fabric for that appliqué piece. See “Appliqué Selection” on page 195.

Margin

Margin leaves a space between the embroidery and the center of the border around it. Margin can be set between -50mm and 50mm. The initial setting is 2.5mm.

Note: For a satin or motif border you may need to adjust the margin to avoid overlapping the embroidery.

Corners

Use rounded or square borders. Rounded is initially selected.

Note: Rounded corners may overlap the corners of the embroidery. You can adjust Margin for the desired effect.

Group

Place the border and the embroidery as a unit on the work area.

Note: Use Reveal Groups  to move and change the embroidery and border separately. See “Reveal Groups” on page 93.

Apply

Place the framed embroidery on the work area.

Creating Motif Underlines

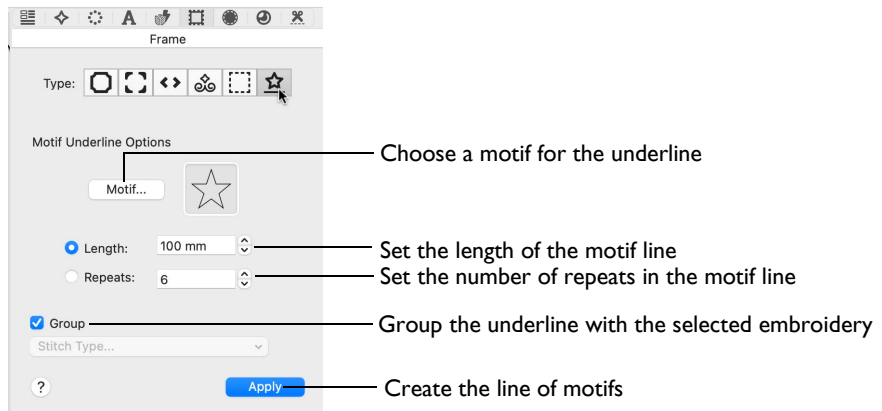

Create a motif line of a chosen length or a selected number of repeats below the currently selected embroidery. Alternatively, place a single motif. The motif line is created below the selected embroidery or embroideries, or in the center of the work area if no embroidery is selected.

Motifs are relatively small single-color designs similar to machine stitches, created using single, running and triple stitches. Motifs are created from the motif sets available in mySewnet™ Embroidery, including any My Motifs you made in mySewnet™ Draw & Paint.

Note: The Motif underline settings are remembered for the current mySewnet™ Embroidery session. Otherwise the system default star motif is selected.

Create a Motif Underline

- Select the length of the motif line, or select the number of repeats. Use the Motif button to select a motif, its stitch type and its size.

Note: The stitch properties may only be adjusted before the motif underline is created.

Create a Single Motif

- Use the Motif button to select a motif, its stitch type and its size. Set Repeats to 1, and click Apply. A single motif is placed in the work area.

Length

Set the Length of the line of motifs.

- Click the arrows to set Length from 10mm to 1000mm.

Repeats

Set the total number of copies of the selected motif in the line.

- Click the arrows to set the number of repeats from 1 to 100.

Note: If motifs are designed to overlap each other the calculation for number of repeats may not be exact.

Motif



Use Motif to select the motif and stitch type for the underline in the Motif Line dialog. See “Motif Line” on page 506.

- Click the Motif button to select the line properties and motif.

Apply

Use Apply to place the line of motifs in the work area as a motif underline.

Create Lines of Butterfly Motifs

- 1 Open the Frame  window.
- 2 In Type, select Motifs  to create a motif underline.
- 3 In the Motif Underline section, click the Motif button. The Motif Line selection dialog opens. See “Motif Line” on page 506.
- 4 In the Motif Line selection dialog, click the Motif button. The Motif dialog opens. See “Motif Selection” on page 509.
- 5 Select Universal from the Group pop-up menu.
- 6 Select General Motifs 1 from the Category pop-up menu.
- 7 In the Pattern pop-up menu, select motif 23, a butterfly. The Height and Width are initially set according to the chosen motif.
- 8 Check that Proportional  (lock closed) is on.
- 9 Set Height to 14mm.
- 10 Click OK to set the motif.
- 11 In the Motif Line selection dialog, ensure that stitch type is set to Running.
- 12 Set Length to 2.0mm. *Note:* Length is initially set to the recommended value for the motif.
- 13 Click OK to select the butterfly motif line type.
- 14 In the Motif Underline section of the Frames window, click Length to select it.
- 15 Set the Length to 100mm.

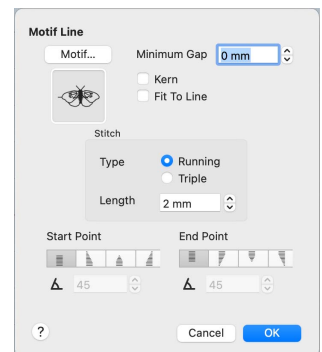
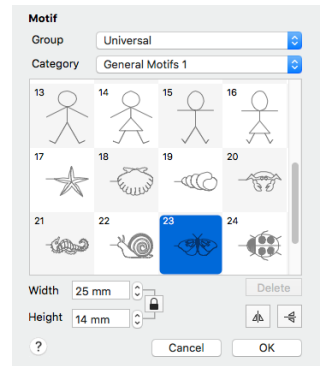

16 Click Apply. A line of four butterflies is placed on the work area.

The width of the butterfly motif is 25mm, so the line contains four motifs.

Note: You can resize or rescale this line of motifs, or change its color, in the same way as for any other design.

17 Set Length to 120mm and click Apply again. There are still four motifs, but they are more widely spaced.

Only complete motifs are used when placing a motif line with Motif Underline.

Note: The second motif line forms a Group with the first line. Use Reveal Groups or Ungroup to use the lines independently.

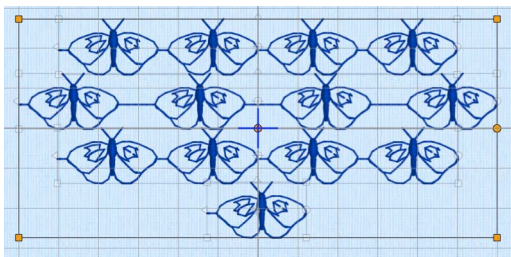

18 In the Motif Underline section, select Repeats.

19 Click the arrows to set the number of repeats to four, then click Apply.

The motif line is the same size as the first line you created.

20 Click the arrows to set the number of repeats to one, then click Apply. This places a single motif in the work area.

Note: Use Encore to create curved motif lines, circles and shapes using single motifs, and to mirror motifs within a line. See “Encore” on page 103.

This chapter describes how you can change the properties for many line and fill stitch types in fonts, SuperDesigns and frames.

Editable Properties

Many fonts, sets of SuperDesigns and frames will allow their line and fill properties to be changed. However, some fonts and sets of SuperDesigns use more than one fill pattern or motif type, so there is no single uniform property that can be changed for the whole font or set of SuperDesigns. Where multiple properties are used, the edit properties functions are not available. For example:

- In the Elegant category, American Gothic 25-75mm has Satin Column stitches, therefore the satin properties dialog is available.
- In the Display category, Stencil UC 15-100mm has one type of pattern fill stitch, therefore the Pattern Fill properties dialog is available.
- In the Monogram category, Athletic Square 2C UC 30-80mm has both satin and pattern fill stitches, therefore two properties dialogs are available.
- In the Floral category, Acorn 6C UC 35-60mm uses more than one fill pattern. Therefore no stitch properties settings are available.

Stitch Type

The properties for a stitch type can be changed using its properties dialog before or after the lettering, SuperDesign or frame is created.

Note: You can only edit the stitch properties for a design with green handles (before it is fixed as an embroidery).

To open stitch properties

- Control-click on the lettering, SuperDesign or frame in the work area, and choose the stitch type from the context menu.
- In the Letter, SuperDesign or Frame panel, click the ellipsis (3 dots) pop-up menu and choose the stitch type.

To open the stitch properties for lettering

- Control-click on the lettering in the work area, and choose the stitch type from the context menu.

To open the stitch properties for a SuperDesign

- Control-click on the SuperDesign in the work area, and choose the stitch type from the context menu.

To open the stitch properties for a frame

- Control-click on the frame in the work area, and choose the stitch type from the context menu.

Pattern Fill

A pattern fill area is an area of stitching where the threads all lie parallel to each other, and that has stitch points inserted to create different types of patterns. The density and color can also be changed with single gradient density and multicolor gradient density. Add new Patterns using Manage My Fills in mySewnet™ Digitizing.

The patterns may be simple textures or decorative shapes. A satin-effect pattern (pattern number 36 in Standard 3) is also available.

Pattern Fill

Use the Pattern Fill dialog to set the properties on a pattern fill area.

The patterns may be simple textures or decorative shapes. A satin-effect pattern (pattern number 36 in Standard 3) is also available.

Pattern Fill

Use the Pattern Fill dialog to set the properties on a pattern fill area.

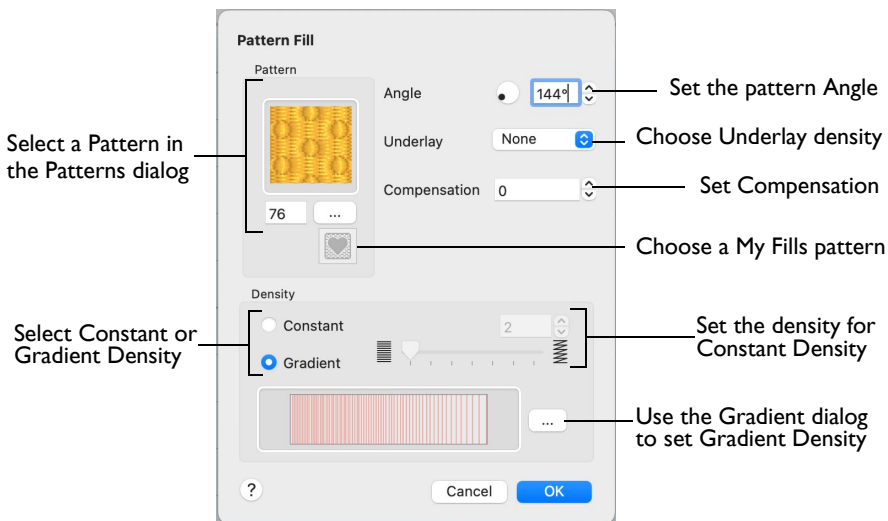

Pattern

Choose a fill pattern in the Pattern viewer. See “Pattern” on page 465.

Angle

The angle of the fill pattern, as shown by the rotational slider and number box. The thread is at a right angle to the fill pattern. You can set the Angle from 0 to 359 degrees.

Note: The fill angle also affects the orientation of a gradient fill.

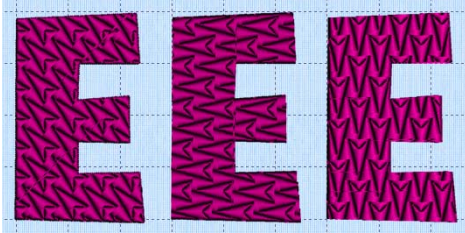
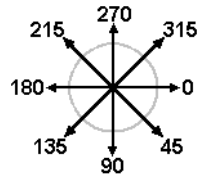

The example shows pattern number 56 from Litho font, Modern category, with the fill angle set to 315, 270 and 180 degrees.

Underlay

Underlay is a low density fill that is perpendicular to the stitches of the actual fill area. It is useful for stabilizing large fill areas.

Note: Underlay stitches are not generated for areas using gradient density. However it can be selected, as you may change the area to constant density.

- Choose None, Low, Medium or High density underlay from the pop-up menu.

Compensation

Compensation is used to make an area 'bolder' by increasing its relative size. The higher the number, the bolder the area appears. The initial setting is 0.

- Click the arrows to set Compensation from 0 to 20, or enter a value in the number box.

Density

Constant density creates a uniform fill at the chosen density. Gradient density creates a fill with varying density or color.

Note: Embroidery on thick fabrics usually looks better with more stitch coverage (a low density setting). Choose a low value such as 2 or 3 for heavy knit fabrics, and a higher value such as 5 or 6 for a light material such as linen or satin.

- Select between Constant and Gradient density.

Setting Constant Density

The lower the number, the closer together the stitches and the more stitches are produced. You can set Density from 2 to 40.

- Select Constant, then use the slider or the number box to set the Density.

Setting Gradient Density

- Select Gradient, then click the ellipsis button (3 dots) to open the Gradient dialog. See “Gradient” on page 466.

Change a Pattern Fill

- 1 Open the Pattern Fill dialog. See “Pattern Fill” on page 463.
- 2 Click the button with the ellipsis (three dots) to open the Pattern viewer.
- 3 Scroll through the Pattern categories, and click a pattern to select it.
- 4 Set the angle for the pattern.
- 5 Click OK to close the Pattern Fill dialog and view your changes.

Pattern

Use the Pattern viewer to select the pattern used for fill areas.

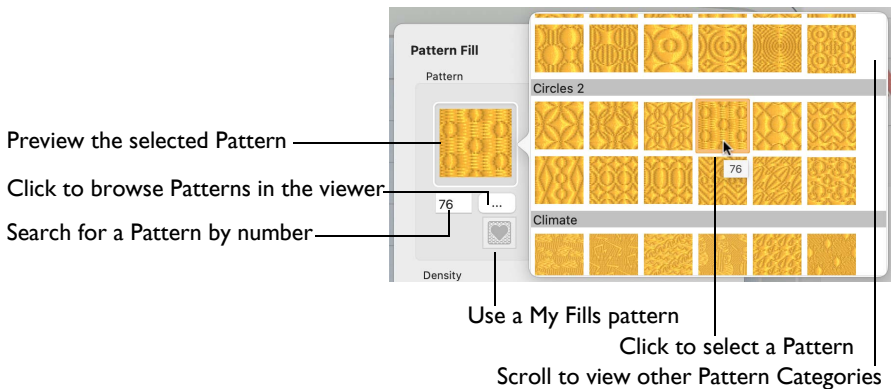

Selecting a Pattern

The current pattern is highlighted when the viewer is opened.

- Scroll through the pattern viewer, and click to choose a Pattern.
- Enter a Pattern number directly in the Pattern box.
- Click My Patterns , or scroll to My Patterns to use a fill from those you have imported in mySewnet™ Digitizing.

For the full list, see “Fill and Satin Patterns” on page 511.

Patterns in categories other than Standard are recommended for use in relatively large fill areas, as they have repeating patterns which work well when 'tiled' together.

- Pattern 36 produces a 'satin effect' fill stitch.
- The first four patterns in the Gradient & Lace category (253-256) are recommended for multicolor gradient.
- Patterns 257 to 264 provide banded fill patterns that combine with crosshatch parallel fills to create a weave effect for lace designs. Set Spacing for the parallel

fill at 2.4mm to combine with Pattern 257, 2.8mm to combine with Pattern 258, and so on.

Gradient

Use the Gradient dialog to see and change the gradient density or the color gradient of a fill.

Single Color Gradient

Use Single Color Gradient to change the density across a fill with only one color. Set a value for the start and end density markers for the fill, and the density gradually changes between the two values. Add multiple markers for a more complex pattern. The higher the value, the less dense the fill.

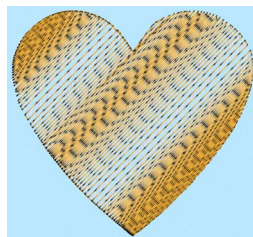

Note: Use Single Color Gradient for loosely stitched areas so that the traveling stitches will go around the outside of the fill area. Set the Start and End densities to the same number.

Use the adjustment marker above the gradient bar to change the gradient across the fill.

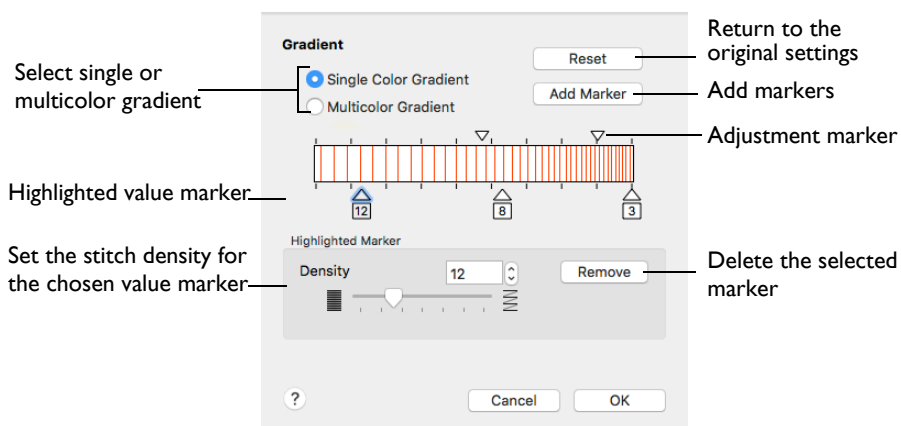

The markers can each take a value of 2 to 40, which means you can reverse the gradient simply by swapping the start and end values. A higher value means the fill is less dense.

The initial start marker density setting is 2, and the end marker density setting is 8.

Reset

Return to the initial settings.

Add Marker

Add Marker places a new value marker below the gradient bar, and an extra adjustment marker above the gradient bar. The initial value for the marker is between the existing markers. Any combination of density values is possible across a fill area.

- Click Add Marker to add new markers, then edit the density value and move the value and adjustment markers as desired.

Density

Set the fill density. The higher the number, the less dense the fill.

- Use the slider or the number box to set the Density of the stitching from 2 to 40.

Remove

Click Remove to delete the highlighted marker.

Using Single Color Gradient

- 1 Open the Pattern Fill dialog. See “Pattern Fill” on page 463.
- 2 Select Gradient.
- 3 Click the ellipsis (3 dots) button to open the Gradient dialog.
- 4 Select Single Color Gradient.
- 5 Click a value marker (the marker below the gradient bar) and change the number in the Density box to the required density value.
- 6 Press Return to refresh the gradient bar with the new number.
- 7 Move the adjustment marker above the gradient bar to vary the change in density across the fill.
- 8 Click Add Marker to add another value marker and adjustment marker.
- 9 Change the density of the fill as desired.
- 10 Click OK twice to close the Gradient dialog and the Pattern Fill dialog, and view your changes in the work area.
- 11 To adjust your settings, Control-click the lettering, SuperDesign or Frame, and then choose Pattern Fill from the context menu. The Pattern Fill dialog reopens.

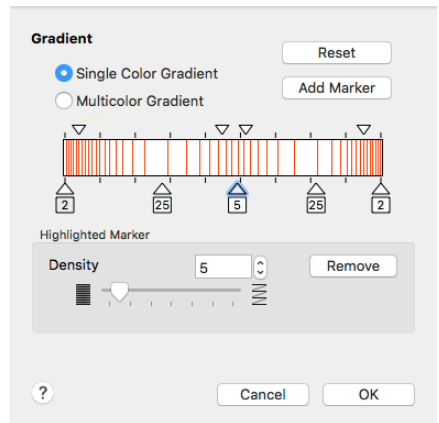

Multicolor Gradient

Use Multicolor Gradient to change the color across a fill with only one density. Set colors for the start and end markers for the fill, and the color gradually changes between the two values. Add extra markers for further color changes. Any combination of colors is possible across a fill area.

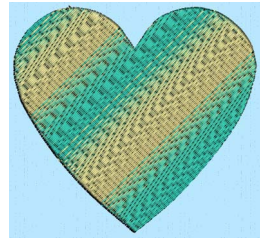

Use the markers above the gradient bar to change the color gradient across the fill.

The screenshot shows the 'Gradient' dialog box with the following callouts:

- Select single or multicolor gradient:** Points to the radio buttons for 'Single Color Gradient' and 'Multicolor Gradient'.
- Return to the original settings:** Points to the 'Reset' button.
- Add markers:** Points to the 'Add Marker' button.
- Adjustment markers:** Points to the small triangles above the gradient bar.
- Selected color marker:** Points to a color marker on the gradient bar.
- Choose a thread for the highlighted color marker:** Points to the 'Thread Color' field and the color selection icon.
- Delete the selected marker:** Points to the 'Remove' button.
- Set the stitch density for the whole fill:** Points to the 'Density' field and the density slider.

Change the color on a fill area over a range, or use multiple color changes across a fill, to create gradual color changes for a sunset, or subtle shadow effects.

Note: Embroidery on thick fabrics usually looks better with more stitch coverage (a low density setting). Choose a low value such as 2 or 3 for heavy knit fabrics, and a higher value such as 5 or 6 for a light material such as linen or satin.

Reset

Return to the initial settings.

Add Marker

Add Marker places an new color marker below the gradient bar, and an extra adjustment marker above the gradient bar. The initial color for the marker is the same as the currently highlighted marker.

- Click Add Marker to add new markers, then change the colors and move the color and adjustment markers as desired.

Thread Color

Use Thread Color to change the color of the highlighted marker.

- Click Thread Color to open the Color Selection dialog.

Remove

Click Remove to delete the highlighted marker.

Create a Multicolor Gradient Fill

- 1 Open the Pattern Fill dialog. See “Stitch Type” on page 462.
- 2 Select Gradient.
- 3 Click the ellipsis (3 dots) button to open the Gradient dialog.
- 4 Select Multicolor Gradient.
- 5 Click a color marker (the marker below the gradient bar) and click Thread Color  to open the Color Selection dialog. See “Color Selection Dialog” on page 79.
- 6 Change the color to the required color and click OK.
- 7 Move the adjustment marker above the gradient bar to vary the change in color across the fill.
- 8 Click Add Marker to add another color marker and adjustment marker.
- 9 Change the color of the fill as desired.

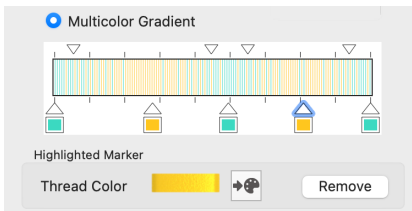

- 10 Click OK twice to close the Gradient dialog and the Pattern Fill dialog, and view your changes in the work area.
- 11 To adjust your settings, Control-click the lettering, SuperDesign or Frame, and then choose Pattern Fill from the context menu. The Pattern Fill dialog reopens.

Motif Fill

Motif fill areas contain repeated small stitches placed using a Universal or machine motif pattern. Motifs are used at any angle, at varying sizes, and alternate lines can use different motifs. Typically, there are spaces between the motifs in a pattern.

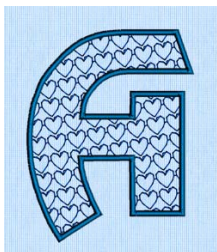

Motif fill using a heart pattern, number 6, in the General Motifs 1 category, at an Angle of 350 degrees. A satin line is used for the border.
(Revue 2C UC 25-120mm MF, Display category)

In the Motif Fill dialog you can select motifs, and set the motif angle, spacing, offset, stitch type and length when creating a motif fill area. Use Motif 1 to select the first motif and its size, and Motif 2 for a second optional motif.

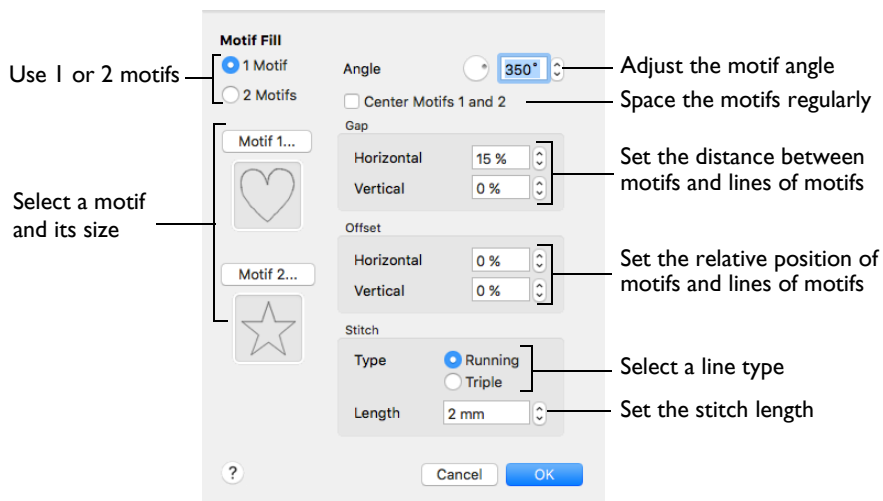

Motifs

Set the number of motifs in the fill to 1 or 2, and select the motif(s) and their size. A second motif is placed on alternating lines with the first motif.

To select motifs for a fill

- Decide whether to use 1 or 2 motifs, then click the Motif 1 or Motif 2 button to open the Motif Selection dialog. See “Motif Selection” on page 509.

Angle

Change the angle of the motif fill pattern from 0 to 359 degrees.

Center Motifs 1 and 2

When selected, extra stitches are added to either side of the narrower of the two motifs, so it is the same width as the wider motif. The motifs then can be centered, and any horizontal offset between them is constant.

Gap

Use Horizontal gap to add or remove space between motifs along a line, and Vertical gap to add or remove space between lines of motifs. Horizontal and Vertical gap can be set from -50% to +100%.

Offset

Use Horizontal offset to move motifs along a line, relative to their position in the previous line. Use Vertical offset to adjust the position of a line of motifs, relative to the previous line of motifs. Horizontal and Vertical offset can be set from -50% to 50%.

Stitch

Select between Running and Triple stitch for stitching out the motif line.

Set the maximum stitch Length from 1 to 12mm in steps of 0.1mm.

Change a Motif Fill

- 1 Set the hoop size to 240mm x 150mm - Universal Large Hoop 2, Rotated. See “Hoop Selection” on page 22.
- 2 In the work area, use a Horizontal line type to create the name "Jane" using the font Display, Inform UC 25-120mm MF and set the Size to 50mm. See “Create Lettering” on page 356. This motif fill font uses a single Hand Stitches 1 motif (number 2) at an angle of 350 degrees, with no gap and a 50% horizontal offset.
- 3 Control-click the lettering and choose Motif Fill to change the fill properties.
- 4 Click the Motif 1 button to change the motif in the Motif selection dialog. See “Selecting a Motif” on page 510.
- 5 Leave Group as Universal, then choose the General Motifs 1 category from the pop-up menu.
- 6 Select motif 7, a circle.
- 7 Check that Proportional  (lock closed) is on, and set Width and Height to 5mm. Then click OK.
- 8 In Motif Fill click OK to apply your changes. The motifs are closely packed together.
- 9 Control-click the lettering and open the Motif Fill dialog again.
- 10 Set Horizontal Gap to 25% and click OK. Separate circles are now linked by stitch lines.
- 11 Open the Motif Fill dialog again and set Vertical Gap to 25%. Then click OK. There is now a greater gap between the lines of motifs.

- 12** Ensure the Horizontal Offset is set to 50% and set Vertical Offset to 50%. Click OK. The motif lines now form pairs with no gap, and a large gap between each pair of lines.

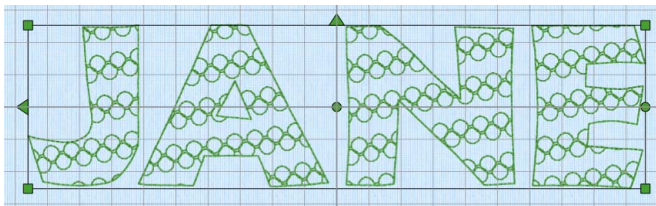

- 13** In the Motif Fill dialog, select 2 Motifs.
When two motifs are used, they are placed on alternate lines.
- 14** Click the Motif 2 button. The motif is set to the star, number 5 in the General Motifs I category, with a size of 8mm.
- 15** Click OK twice to view the new settings unchanged.
As the star is larger than the circle, the motifs are irregularly placed.
- 16** Open the Motif Fill dialog and select Center Motifs 1 and 2. Then click OK.
The gap between the circle motifs has been increased so that the two motifs are now regularly spaced.

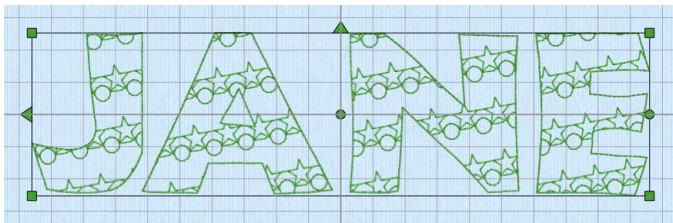

Center Motifs 1 and 2 adds space at either side of the smaller motif, to make the two the same size.

Crosshatch Fill

Crosshatch fills are used in quilting, and to create free-standing lace.

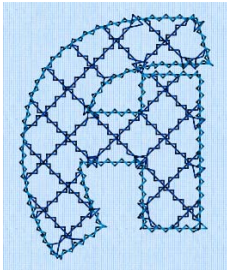

Crosshatch Fill, using Diamond style and an Angle of 45 degrees. Double Zigzag is the stitch used in the fill and for the border.
(Revue Patchwork UC 50-120mm XH, Display category)

The Crosshatch Fill properties dialog enables you to set the gap, style, line angle, stitch type and stitch length for the crosshatched lines of stitching in the fill. The preview changes according to the options chosen.

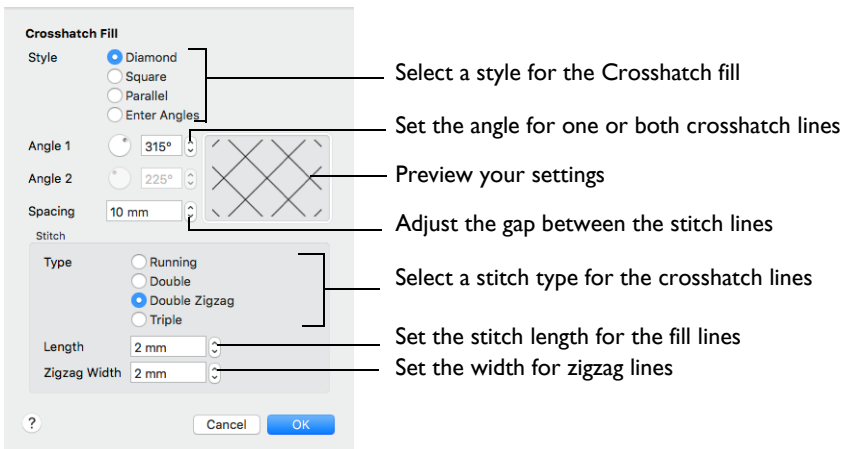

Style

Select Diamond, Square, Parallel or Enter Angles.

- **Diamond** creates a symmetrical crosshatch pattern (balanced horizontally).
- **Square** creates a crosshatch pattern of lines set at 90 degrees.
- **Parallel** creates a pattern of parallel lines, with an initial angle of 0 degrees.
- **Enter Angles** can be used to create an asymmetrical crosshatch pattern. Enter an angle for each of the two line directions in the crosshatch.

Note: The Pattern Fills 257 to 264 provide banded fill patterns that combine with crosshatch parallel fills to create a weave effect. Set Spacing for the parallel fill at 2.4mm to combine with Pattern 257, 2.8mm to combine with Pattern 258, and so on.

Angle 1

Use Angle 1 to set the line angle for Diamond, Parallel and Enter Angles fill. Angle 1 is initially set to the same angle as the Diamond style previously used.

Angle 2

Use Angle 2 to set the line angle for the second line in Enter Angles crosshatch fill. Angle 2 is initially set to Angle 1 plus 90 degrees.

Spacing

Set the Gap for the desired distance between the lines of stitching. You can set Gap from 5mm to 20mm in steps of 1mm. It is initially set to 10mm.

Stitch Type

Select a stitch type for the crosshatch fill. Choose from:

- Running Stitch
- Double Stitch
- Double Zigzag
- Triple Stitch

Note: Double Zigzag is a special stitch type, recommended for lace. A running stitch line is retraced in a zigzag pattern to create a mesh. After embroidering on water soluble stabilizer, the mesh of stitches provides strength when the stabilizer is washed away.

Stitch Length

Set the Stitch Length for the line type used in the crosshatch fill. You can set Stitch Length from 1 to 12mm in steps of 0.1mm. The initial setting is 2.0mm.

Zigzag Width

Set the Zigzag width for Double Zigzag stitch from 0.2 to 6mm in steps of 0.1mm. The initial setting is 0.6mm.

Change a Crosshatch Fill

- 1 Set the hoop size to 240mm x 150mm - Universal Large Hoop 2, and set the Orientation to Rotated. See "Hoop Selection" on page 22.
- 2 In the work area, create the name "James" using the font Display, Revue Patchwork UC 50-120mm XH and set the Size to 50mm. See "Create Lettering" on page 356. This crosshatch fill font uses Double Zigzag stitching in a Diamond style with an angle of 225 degrees, and a spacing of 10mm.
- 3 Control-click the lettering and choose Crosshatch Fill to change the fill properties.
- 4 Set Spacing to 8mm. The preview on the right changes.
- 5 Set Angle 1 to 30 degrees. The preview reflects your changes.

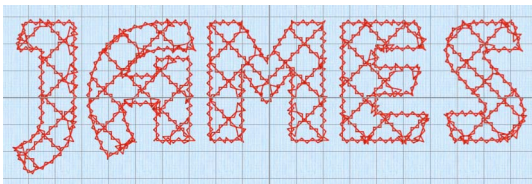

Note that Angle 2 is dimmed.

- 6 Click OK to view your changes in the work area.
- 7 Control-click the lettering again and choose Crosshatch Fill to open the properties dialog.
- 8 In Style, select Enter Angles. Angle 2 is now available.
- 9 Set Angle 2 to 100 degrees.
- 10 Click OK to view your changes in the work area, then open the Crosshatch Fill dialog again.

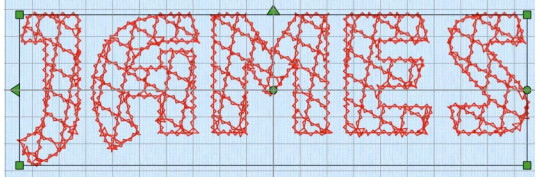

- 11 In Style, select Parallel. Angle 2 is no longer available, and its angle is now identical to Angle 1.
- 12 Change Angle 1 to 70 degrees.
- 13 Click OK to view your changes in the work area, then open the Crosshatch Fill dialog again.
- 14 In Style, select Square.

Neither Angle 1 nor Angle 2 is available, and their values are 0 degrees and 90 degrees.

- 15 Click OK to view your changes in the work area, then open the Crosshatch Fill dialog again.
- 16 Set Zigzag width to 4mm. This changes the stitch lines in the fill.
- 17 Click OK to view your changes in the work area. The stitch lines are much wider.
- 18 Open the Crosshatch Fill dialog again.

- 19 Change Stitch Type to Running (running stitch). Note that Zigzag Width is no longer available.

- 20 Click OK to view your changes in the work area. The square crosshatch now consists of fine stitch lines.

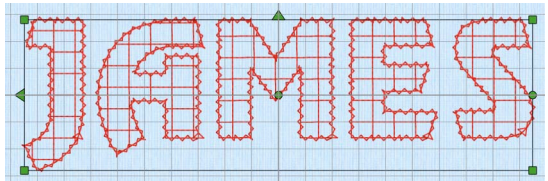

Curved Crosshatch Fill

Curved Crosshatch fills use curving lines in the crosshatch, which can be used to create a feeling of depth. They are used in quilting, and to create free-standing lace.

The Curved Crosshatch Fill properties dialog enables you to set the curve, gap, style, line angle, stitch type and stitch length for the curved crosshatched lines of stitching in the fill, and to use Motif lines for the fill.

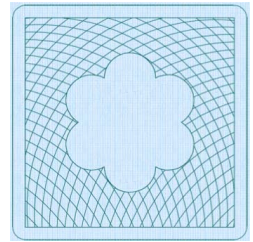

Curved Crosshatch Fill

Style Diamond
 Square
 Parallel
 Enter Angles

Angle 1
Angle 2
Spacing

Curve Lines 1
In
Out

Curve Lines 2
In
Out

Stitch Type
Type Running Stitch
 Double Stitch
 Triple Stitch
 Motif Line
Stitch Length

Motif Line Options
Motif...
 Kern
 Fit To Line
Stitch Type Running
 Triple
Stitch Length

Buttons: Cancel, OK

Callout 1: ?
Set the angle for one or both curved crosshatch lines

Callout 2: ?
Set the gap between the fill lines

Callout 3: ?
Set a curve for the curved crosshatch lines

Callout 4: ?
Choose a Motif for the fill lines

Callout 5: ?
Select a stitch type and length for the curved crosshatch fill lines

Callout 6: ?
Select a stitch type and length for the curved crosshatch motif fill lines

Callout 7: ?
Adjust the gap between the motif lines

Callout 8: ?
Select a style for the Curved Crosshatch fill

Style

Select Diamond, Square, Parallel and Enter Angles.

- **Diamond** creates a symmetrical crosshatch pattern (balanced horizontally).
- **Square** creates a crosshatch pattern of lines set at 90 degrees.
- **Parallel** creates a pattern of parallel lines, with an initial angle of 0 degrees.
- **Enter Angles** can be used to create an asymmetrical crosshatch pattern. Enter an angle for each of the two line directions in the crosshatch.

Note: The Pattern Fills 257 to 264 provide banded fill patterns that combine with crosshatch parallel fills to create a weave effect. Set Spacing for the parallel fill at 2.4mm to combine with Pattern 257, 2.8mm to combine with Pattern 258, and so on.

Spacing

Set the Gap to the preferred distance between lines of stitching. Set the Gap from 1mm to 20mm in steps of 0.1 mm. It is initially set to 5mm.

Curved Crosshatch

Use Lines 1 and 2 to change the curve on the crosshatch lines.

Note: You can also change the curves in the crosshatch lines using the handles in the work area.

Lines 1: Change the position of the origin for one of the sets of curved lines.

- Set percentage Curve In and Curve Out from -100 to 100. The initial setting for Curve In % and for Curve Out % is 50.

Lines 2: Change the position of the origin for the other set of curved lines.

- Set percentage Curve In and Curve Out from -100 to 100. The initial setting for Curve In % and for Curve Out % is 50.

Stitch Type

Select a stitch type for the curved crosshatch fill. Choose from:

- Running Stitch
- Double Stitch
- Triple Stitch
- Motif Line

Stitch Length

Set the Stitch Length for the line type used in the curved crosshatch fill. You can set the Stitch Length from 1 to 12mm in steps of 0.1mm. The initial setting is 2.0mm.

Motif Line Options

The selected Motif is only used by the Curved Crosshatch Fill if the Motif Line option is selected.

Motif

- Click Motif to select a motif and its size in the Motif Selection dialog. See “Motif Selection” on page 509.

Minimum Gap

The Minimum Gap is the minimum amount of extra stitching that is placed between the motifs along the line. This is in addition to any spacing that is part of the selected motif.

Fit To Line

Select this option to make the shape of the motifs follow the curves of the line.

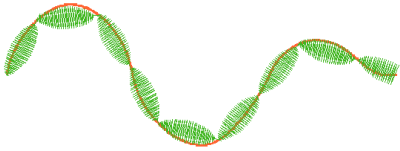

When Fit To Line is off, the ends of each motif are placed on the line.

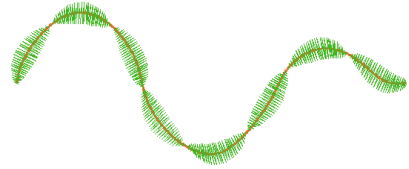

When Fit To Line is on, each motif is adjusted to fit along the line.

Kern

- Use Kern to automatically increase the space between adjacent motifs where necessary, so that the motifs fit along the line without overlapping.

Stitch

- Select Running or Triple stitch for stitching out the motifs. Set the maximum stitch Length from 1 to 12mm in steps of 0.1mm. Length is initially set to the recommended value for each motif.

MultiWave Fill

MultiWave fill areas use a wave pattern defined by a line, or lines, drawn on the fill area by the designer. Vary the density, or use a motif for the stitch lines.

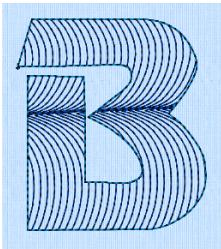

MultiWave Fill, using a density of 20 and a Triple Stitch border.
(Revue UC 25-120mm MW, Display category)

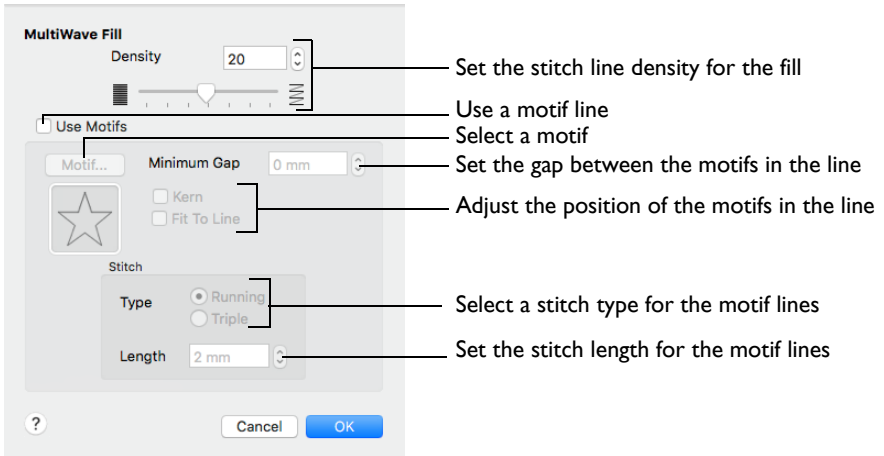

Density

Create a uniform fill at the chosen density. The lower the number, the closer together the stitches and the more stitches are produced. You can set Density from 2 to 40.

- Use the slider or the number box to set the Density.

Use Motifs

Use a motif line instead of a plain line to follow the line angle selected for the fill.

- Select the Use Motifs checkbox, then click the Motif button to choose a motif. See "Motif Selection" on page 509.

Minimum Gap

This is the minimum amount of extra stitching that is placed between the motifs along the line. Minimum Gap is in addition to any spacing that is part of the selected motif.

Fit To Line

Select how the motifs follow the curves of the line.

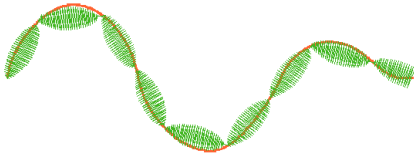

When Fit To Line is off, the ends of each motif are placed on the line.

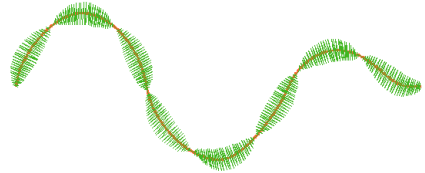

When Fit To Line is on, each whole motif is adjusted to fit along the line.

Kern

Kern automatically increases the space between adjacent motifs, so that the motifs fit along the line without overlapping.

Stitch

Select between Running and Triple stitch for stitching out the motif line.

Set the maximum stitch Length from 1 to 12mm in steps of 0.1mm.

Note: Length is initially set to the recommended value for each motif.

Adjust a MultiWave Fill

- 1 Set the hoop size to 240mm x 150mm - Universal Large Hoop 2, and set the Orientation to Rotated. See "Hoop Selection" on page 22.
- 2 In the Letter window, enter the name "Alice" using the font Display, Revue UC 25-120mm MW and set the Size to 50mm. See "Create Lettering" on page 356.
- 3 Choose MultiWave Fill in the Stitch Type pop-up menu. The MultiWave Fill dialog opens.
- 4 Note that the fill uses a Density of 20.
- 5 Click OK twice to close the MultiWave Fill dialog.
- 6 Click Apply to place the lettering on the work area. The lines in the fill are widely spaced.
- 7 Drag the lettering to the bottom of the screen so that you can see it easily.
- 8 Control-click the lettering and choose MultiWave Fill to change the fill properties.
- 9 Set the Density to 10, then click OK.
The fill is now closely spaced.
- 10 Control-click the lettering again and choose MultiWave Fill to open the properties dialog.
- 11 Set the Density to 40, then click OK.
The fill is now very widely spaced.
- 12 Control-click the lettering again and choose MultiWave Fill to open the properties dialog.
- 13 Reset the Density to 20, then select Use Motifs. The motif area becomes available.
- 14 Click the Motif button. The Motif selection dialog opens.

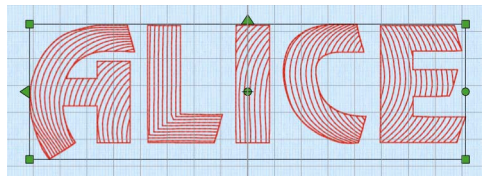

- 15 In the Universal Group, General Motifs I Category, select the motif in row 1, column 2 (number 2).
- 16 Click OK twice to close the Motif selection dialog and the MultiWave Fill dialog. The running stitch fill lines have been replaced by motif lines with closely spaced motifs.
- 17 Open the MultiWave Fill dialog and the Motif selection dialog.
- 18 Click Flip Vertically , and close both dialogs. The pattern on alternate lines in the fill is reversed.
- 19 Open the MultiWave Fill dialog.
- 20 Set the Minimum Gap to 2mm and click OK. There are now gaps between the motifs in the lines.
- 21 Open the MultiWave Fill dialog.
- 22 Try the effects of selecting Kern and Fit To Line.

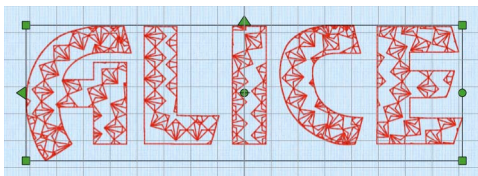

Echo Fill

Echo Fill places echo lines within or around a shape. Choose from rounded, square and diagonal corners, and set the gap between the echo lines.

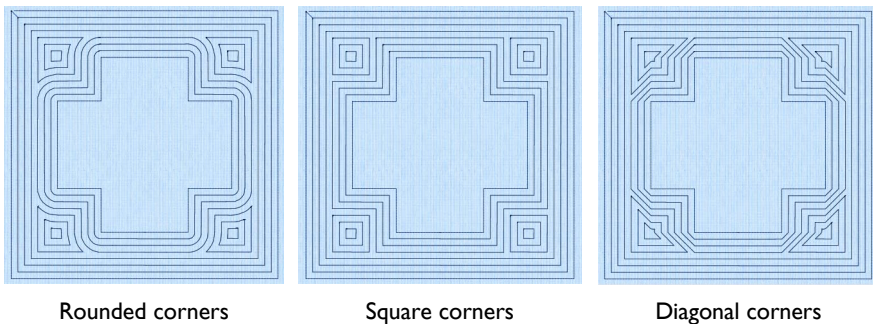

Echo Fill Properties

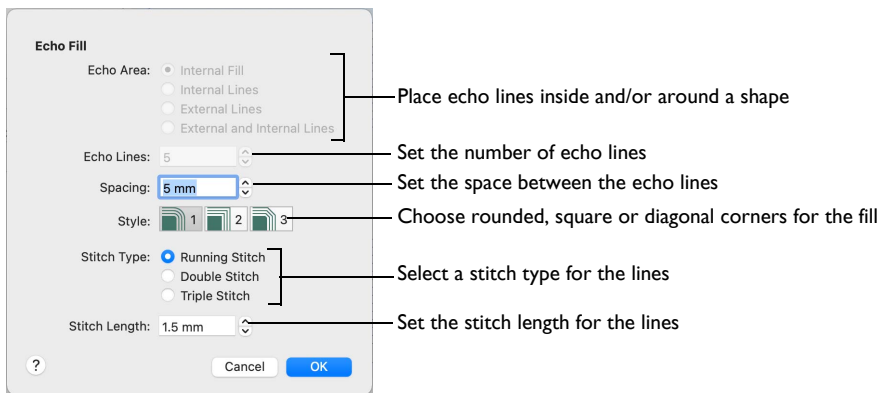

The Echo Fill properties dialog enables you to place echo lines within a shape. Set the style, gap, stitch type and stitch length.



Note: Some options used in other apps are unavailable in mySewnet™ Embroidery. For an example using Echo Fill, see “Show an Echo Around an Embroidery” on page 255.

Style

Choose from 1, 2 or 3. For a square shape:

- 1  creates rounded corners
- 2  creates square corners
- 3  creates diagonal corners

Rounded corners (1) is initially selected.

Stitch type

Select a line type for the echo lines in the fill. Choose from:

- Running Stitch
- Double Stitch
- Triple Stitch

Spacing

Set the Spacing to the preferred distance between lines of stitching.

Set the Spacing from 2mm to 20mm in steps of 0.1mm. It is initially set to 5mm.

Stitch Length

Set the stitch length for the echo lines from 1 to 12mm in 0.1mm steps. The initial setting is 2mm.

Shape Fill

Shape fill areas use one of 75 different shapes. Vary the stitch density and use motif lines for the fill.

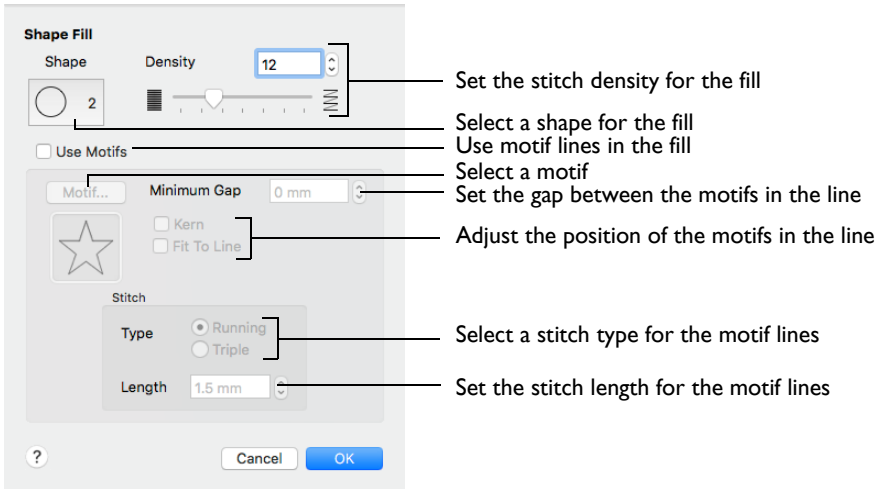

Density

Create a uniform fill at the chosen density. The lower the number, the closer together the stitches and the more stitches are produced. You can set Density from 2 to 40.

- Use the slider or the number box to set the Density.

Shapes

Select one of 75 shapes for the fill.

- Click the Shape button, and choose a Shape from the pop-up menu.

Use Motifs

Use a motif line instead of a plain line to follow the shape selected for the fill.

Note: The displayed motif is only used by Shape Fill if this option is selected.

- Select the Use Motifs checkbox, then click the Motif button to choose a motif. See "Motif Selection" on page 509.

Minimum Gap

This is the minimum amount of extra stitching that is placed between the motifs along the line. Minimum Gap is in addition to any spacing that is part of the selected motif.

Fit To Line

Select how the motifs follow the curves of the line.

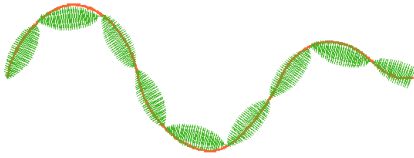

When Fit To Line is off, the ends of each motif are placed on the line.

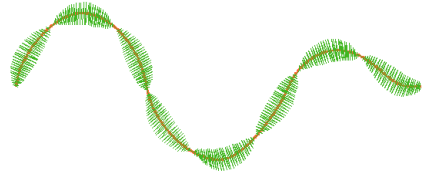

When Fit To Line is on, each whole motif is adjusted to fit along the line.

Kern

Kern automatically increases the space between adjacent motifs, so that the motifs fit along the line without overlapping.

Stitch

Select between Running and Triple stitch for stitching out the motif line.

Set the maximum stitch Length from 1 to 12mm in steps of 0.1mm.

Note: Length is initially set to the recommended value for each motif.

Change a Shape Fill

- 1 Set the hoop size to 260mm x 200mm - Universal Large Hoop 3, and set the Orientation to Rotated. See "Hoop Selection" on page 22.
- 2 Open the SuperDesign window and choose "Zodiac" from the SuperDesign Category pop-up menu.
- 3 Scroll down the SuperDesign window to the Zodiac 3 set.
- 4 Click the design in row 1 column 3 (the archer).
- 5 Set Size to 190mm.
- 6 Click Apply. The SuperDesign is placed in the work area.
- 7 Control-click the SuperDesign and choose Shape Fill to change the fill properties.
- 8 Change the Shape from 2 (a circle) to 5 (a hexagon). The curved lines in the background are now straight.
- 9 Control-click the SuperDesign and choose Shape Fill to change the fill properties.
- 10 Change the Shape from 5 (a hexagon) to 23 (a cross). The background shows the cross pattern clearly.
- 11 Use Undo twice to return to the circle shape.
- 12 In the Shape Fill dialog, set Density to 2 and click OK to view the changes. The the circular lines of stitching form a dense cover.
- 13 In the Shape Fill dialog, set Density to 40 and click OK to view the changes. The fill lines are widely spaced.

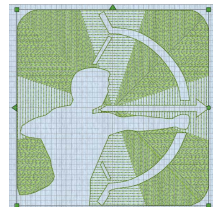
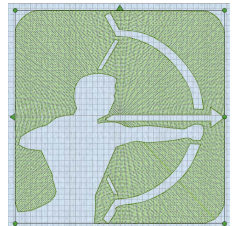

- 14 Use Undo twice to return to a Density of 12.
- 15 In the Shape Fill dialog, select Use Motifs. The motif options become available.
- 16 Click OK. The shape is now filled with concentric lines of stars (the default motif).
- 17 Open the Shape Fill dialog.
- 18 Set the Minimum Gap to 2mm and click OK. There are now gaps between the motifs in the lines.
- 19 Open the Shape Fill dialog and try out the effect of using Kern and Fit To Line.
- 20 Open the Shape Fill dialog and set the Minimum Gap back to 0mm.
- 21 Click the Motif button.
- 22 In the Motif selection dialog, choose Hand Stitches 1 from the Category pop-up menu.
- 23 Select motif number 11.
- 24 Click OK twice to close the Motif selection and Shape Fill dialogs. The archer SuperDesign shows the new motif.

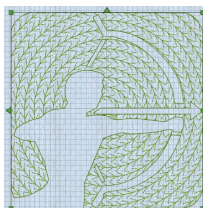
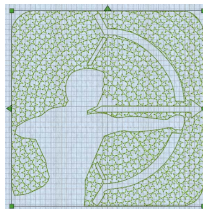

Radial Fill

Radial fill areas use a pattern of radiating lines from an origin point. The stitch density can be varied.

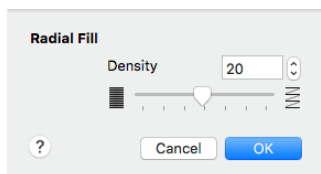

Set the density from 2 to 40

Density

Create a radial fill at the chosen density. The lower the number, the closer together the stitches and the more stitches are produced. You can set Density from 2 to 40. The initial setting is 20.

- Use the slider or the number box to set the Density.

Spiral Fill

Spiral fill areas use a spiral pattern from an origin point. You can use constant or gradient density.

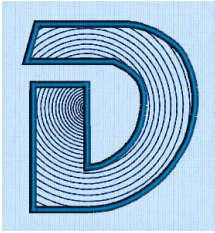

Spiral Fill using Gradient Density with a Satin Line border.
(Revue 2C UC 25-120 SF, Display category)

Change the density on a spiral fill area over a range, or use multiple density changes from the origin to the edge of the fill. There are two density options: Constant and Gradient.

Note: Embroidery on thicker fabrics usually looks better with more stitch coverage, or a low density setting. Choose a low value such as 2 or 3 for heavy knit fabrics, a higher value such as 5 or 6 for a light material like linen or satin.

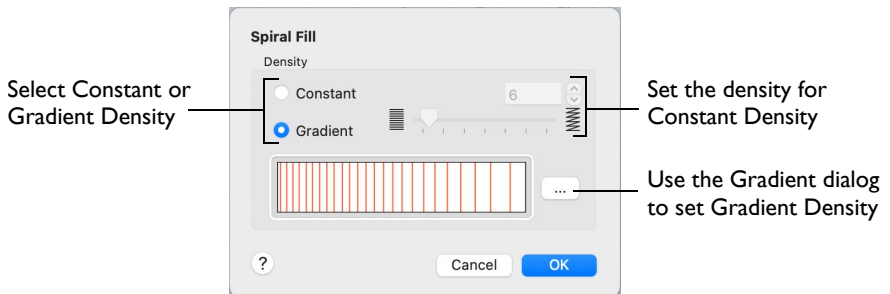

Density

Constant density creates a uniform fill at the chosen density. Gradient density creates a fill with varying density.

- Select between Constant and Gradient density.

Setting Constant Density

The lower the number, the closer together the stitches and the more stitches are produced. You can set Density from 2 to 40.

- Select Constant, then use the slider or the number box to set the Density.

Setting Gradient Density

- Select Gradient, then click the ellipsis button (3 dots) to open the Gradient dialog.

Gradient

Use Gradient Density to change the density across the Spiral Fill. Set a value for the start and end density markers for the fill, and the density gradually changes between the two values. The start value is used at the origin of the spiral fill, and the end value is used at the edge.

Add multiple markers for a more complex pattern. The higher the value, the less dense the fill.

Use the marker above the gradient bar to change the gradient across the fill.

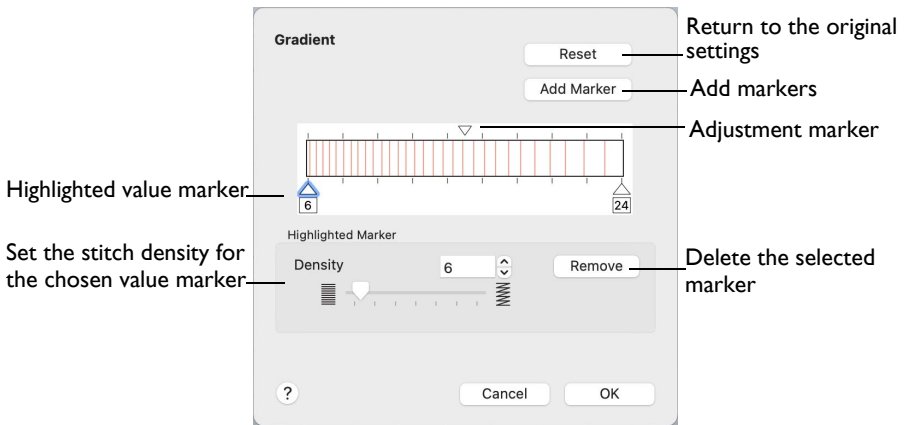

The markers can each take a value of 2 to 40, which means you can reverse the gradient simply by swapping the start and end values.

Reset

Return to the initial settings.

Add Marker

Add Marker places a new value marker below the gradient bar, and an extra adjustment marker above the gradient bar. The initial value for the marker is between the existing markers. Any combination of density values is possible across a fill area.

Note: The marker furthest to the left affects the spiral fill at the origin, then from left to right to the edge of the spiral fill.

- Click Add Marker to add a new markers, then edit the density value and move the value and adjustment markers as desired.

Density

Set the fill density. The higher the number, the less dense the fill.

- Use the slider or the number box to set the Density of the stitching from 2 to 40.

Remove

Click Remove to delete the highlighted marker.

Using Spiral Gradient

- 1 Open the Spiral Fill properties dialog. See “Stitch Type” on page 462.
- 2 Select Gradient.
- 3 Click the ellipsis (3 dots) button to open the Gradient dialog
- 4 Click a value marker (the marker below the gradient bar) and change the number in the Density box to the required density value.
- 5 Move the adjustment marker above the gradient bar to vary the change in density across the fill.
- 6 Click Add Marker to add another value marker and adjustment marker.
- 7 Change the density of the fill as desired.

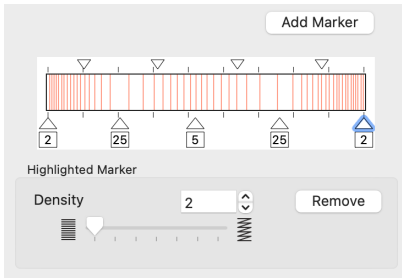

- 8 Click OK twice to close the Gradient dialog and the Spiral Fill dialog, and view your changes on the work area.
- 9 To adjust your settings, Control-click the lettering, SuperDesign or frame and then choose Spiral Fill from the context menu. The Spiral Fill dialog reopens.

QuiltStipple Fill

QuiltStipple fill areas use stipple stitch in curved or straight lines. Vary the gap between stitch lines and use running or triple stitch.

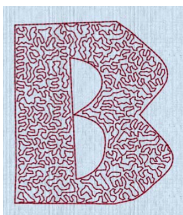

QuiltStipple Fill using a curved style with a Triple Stitch border. (Inform UC 25-120mm QS, Display category)

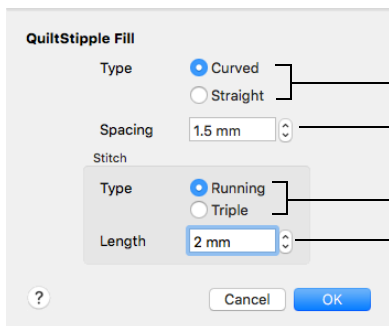

Select curved or straight stipple lines

Set the spacing between the stipple lines

Select a stitch type for the stipple lines

Set the stitch length for the stipple line

Type

Use straight or curved quiltstipple lines in the fill.

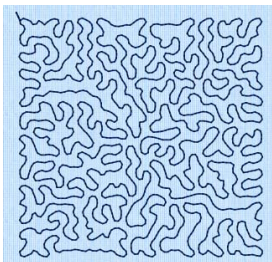

Curved

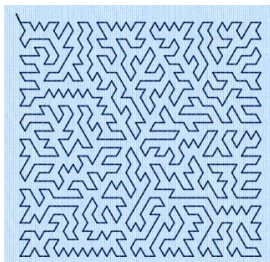

Straight

- Select between curved or straight fill lines.

Spacing

Use Spacing to set the preferred distance between lines of stitching. The distance can be set from 1 to 5mm in steps of 0.1mm. It is initially set to 2.0mm.

Note: Where possible, this is also the border inside the area, between the edge of the area and the fill pattern.

- Click the Spacing up and down arrows, or enter a number.

Stitch

Use **Stitch** to select the stitch type for stitching out the fill, and the length of the stitches used. Set stitch length from 1 to 12mm in steps of 0.1 mm. The initial setting is 2mm.

- Select **Running** or **Triple stitch**, and click the Length up and down arrows, or enter a number.

Contour Fill

Contour fill areas use contour stitch lines. Vary the gap between stitch lines and the length of the stitches, and use running, double or triple stitch.

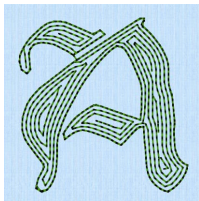

Contour Fill, using Triple Stitch and a 1.0mm gap, and with a Triple Stitch border.
(Per Gothic 25-120mm CF, Elegant category)

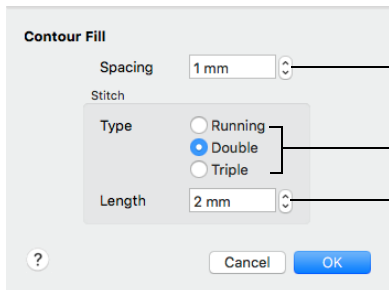

Set the space between the lines in the fill

Select a stitch type for the contour lines

Set a stitch length for the contour lines

Spacing

Use Spacing to set the preferred distance between lines of stitching. The distance can be set from 0.2 to 5mm in steps of 0.1mm. It is initially set to 0.8mm.

Note: This also is the border inside the area, between the edge of the area and the fill pattern.

- Click the Spacing up and down arrows, or enter a number.

Stitch

Use Stitch to select the stitch type for stitching out the fill, and the length of the stitches used. Set stitch length from 1 to 12mm in steps of 0.1mm. The initial setting is 2mm.

- Select Running, Double or Triple stitch, and click the Length up and down arrows, or enter a number.

Satin Area

Satin areas contain zigzag stitches that fill the area from one end to the other at the same density. The stitch angle changes with the shape of the area, and can be adjusted as desired. You can use automatic edge walk and/or zigzag underlay.



In the Satin Area dialog you can set the density, compensation, pattern and underlay for satin areas.

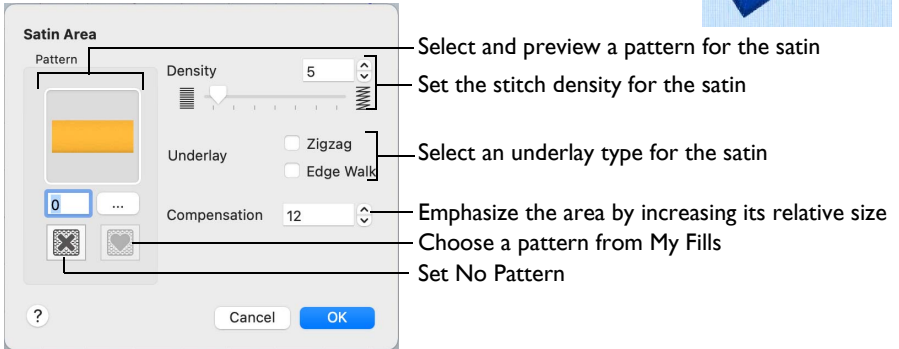

Density

Set Density from 2 to 40. The lower the number, the closer together the stitches and the more stitches are produced.

The initial setting is 4.

Underlay

Set the Underlay option to be used for the satin area. Zigzag creates zigzag lines of running stitch as underlay. Use zigzag underlay for wide areas of satin. Edge walk places lines of running stitch just inside the edges of the satin areas. Use edge walk when the satin areas have both wide and narrow sections. For very wide areas of satin, select both underlay types.

Zigzag is initially selected.

Compensation

Compensation is used to make an area 'bolder' by increasing its relative size. Set Compensation from 0 to 30. The higher the number, the bolder the area appears.

Pattern

Choose from more than 250 patterns for satin (for areas wider than around 8-10mm). The initial setting is 0. Add new patterns using Manage My Fills in mySewnet™ Digitizing.

Note: View the patterns in the pattern viewer. See "Fill and Satin Patterns" on page 511.

- Click a pattern sample or enter the Pattern number to select a pattern.
- Set the Pattern number to 0 for standard satin with no pattern, or click No Pattern.

Satin Column

Satin Column forms a column of straight or curving satin.

In the Satin Column dialog you can set the density, compensation, pattern (for columns wider than around 8-10mm) and underlay.

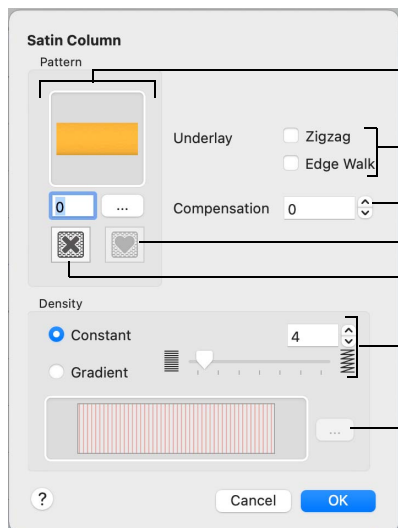

- Select and preview a pattern for the satin
- Select an underlay type for the satin
- Emphasize the area by increasing its relative size
- Choose a pattern from My Fills
- Set No Pattern
- Set the stitch density for the satin
- Use the Gradient dialog to set Gradient Density

Pattern

Choose from more than 250 patterns for satin (for areas wider than around 8-10mm). The initial setting is 0. Add new patterns using Manage My Fills in mySewnet™ Digitizing.

View the patterns in the pattern viewer. See “Fill and Satin Patterns” on page 511.

Note: Patterns can only be used for columns wider than about 8-10 mm.

- Click a pattern sample or enter the Pattern number to select a pattern.
- Set the Pattern number to 0 for standard satin with no pattern, or click No Pattern.

Underlay

Choose Zigzag or Edge Walk underlay. Zigzag creates zigzag lines of running stitch as underlay. Edge walk places lines of running stitch just inside the edges of the satin areas.

Compensation

Compensation is used to make an area 'bolder' by increasing its relative size. Set Compensation from 0 to 30. The higher the number, the bolder the area appears. The initial setting is 0.

Density

Constant density creates a uniform satin at the chosen density. Gradient density creates a satin with varying density or color.

Setting Constant Density

The lower the number, the closer together the stitches and the more stitches are produced. You can set Density from 2 to 40.

- Select Constant, then use the slider or the number box to set the Density.

Setting Gradient Density

- Select Gradient, then click the ellipsis button (3 dots) to open the Gradient dialog. See “Gradient” on page 466.

Feathered Satin

Feathered Satin forms a column of satin that is feathered on one, or both sides. A Feathered Satin column uses zigzag stitches where the start and end points of the stitches are random rather than all parallel.

Choose whether one or both sides of the column are feathered, and set the stitch length and density.

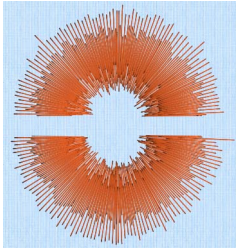

Feather Both Sides

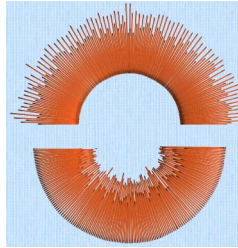

Feather One Side

Use the Feathered Satin dialog to set density, Feather Type, and Stitch Length.

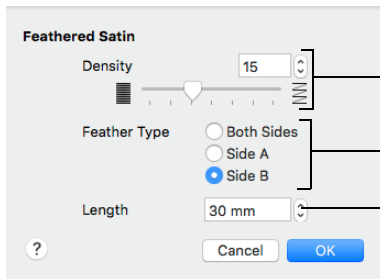

Set the density for the feathered satin

Select which side of the column to feather

Set the length of the feathering stitches

Density

Set Density from 2 to 40. The lower the number, the closer together the stitches and the more stitches are produced. The initial setting is 15.

Feather Type

Select which side of the column to feather. The available options are Both Sides, Side A or Side B, according to the side where the first (A) or second (B) point was placed.

Stitch Length

Set the Length of feathering stitches from 2 to 30mm in steps of 1mm. The initial setting is 30mm.

Feather Both Sides

Create a satin column with both edges feathered.

The start and end points of the stitches are random rather than all parallel. The final width of the section is 2-2.5 times larger than it is for standard satin, as shown.

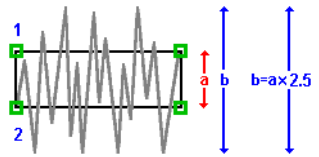

The maximum stitch lengths of the feathered satin may be from 2 to 30mm and the satin density may be from 2 to 40.

Feather One Side

Create a satin column with one edge feathered.

If desired, the feathered side may be altered in the properties dialog.

One edge is feathered, so the start and end points of the stitches on the feathered are random rather than all parallel. The final width of the section is 1.5 to 1.75 times larger than it would be for standard satin, as shown.

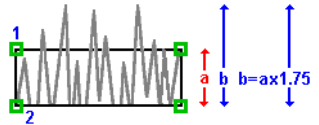

The maximum stitch lengths of the feathered satin may be from 2 to 30mm and the satin density may be from 2 to 40.

Richelieu Bars

Richelieu Bars forms bars in the work area. Richelieu bars are often used in lace designs.

Use the Richelieu Bars dialog to set the width and density of the satin bars, the gap between the bars, and the number of bars.

Set the width for the bars

Set the stitch density for the bars

Set the minimum distance between the bars

Set the number of bars

Place a bar at either end of the column

Select underlay for the Richelieu bars

Width

Set the Width of the satin bars from 1mm to 6mm in steps of 0.1mm. The initial setting is 2mm.

Density

Set the Density of the satin bars from 2 to 15. The initial Density is 4.

Method

Select a method for setting the number of bars.

Select Minimum Gap Size to set the distance between the bars from 1mm to 50mm in steps of 1mm. The initial setting is 6mm.

Select Number of Bars to set the number of bars from 1 to 50. The initial number is 6.

Include Additional First and Last Bar

Place an extra bar at either end of the column. This option is initially selected.

Note: Turn off Include Additional First and Last Bar if the edges of the Richelieu bar area are to be covered by satin.

Underlay

Choose from Edge walk, Center link with zigzag return, and Web double with zigzag return. All three options are initially selected.

- Edge walk places lines of running stitch just inside the edges of the satin bars.
- Center link with zigzag return places a central line of running stitch, with a zigzag return line.
- Web double with zigzag return places a crosshatch pattern of stitching with a zigzag return line.

Note: Vary the combination of underlay, depending on the type of design. It is recommended to use all three types for free-standing lace.

Tapered Motif

Tapered Motif forms columns of motifs. Tapered motifs are often used in lace designs.

Use the Tapered Motif dialog to set the motif type, stitch type, and placement method.

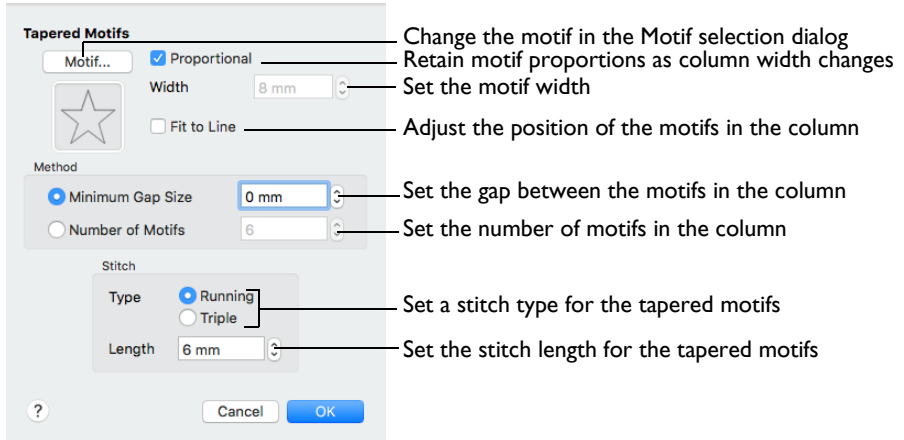

Motif

Select the motif in the Motif selection dialog.

To select tapered motifs

- Click the Motif button to open the Motif selection dialog. See “Motif Selection” on page 509.

Note: As the motif size is set by the column width, the size functions are dimmed in the Motif Selection dialog.

Proportional

Use this option to keep the relative height and width of the motif in proportion when the column width is changed. This option is selected by default.

Width

The Width is initially set according to the chosen motif. The maximum and minimum values for Width are individual to each motif.

Fit To Line

Select how the motifs follow the curves of the line.

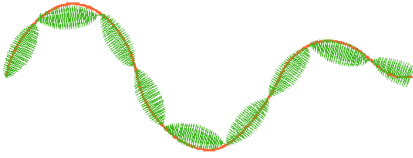

When Fit To Line is off, the ends of each motif are placed on the line.

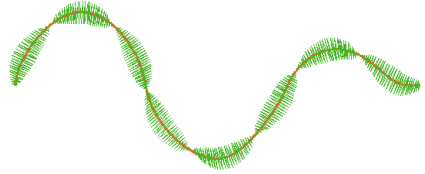

When Fit To Line is on, each whole motif is adjusted to fit along the line.

Method

Minimum Gap Size

The Minimum Gap is the minimum amount of extra stitching that is placed between the motifs along the line. This is in addition to any spacing that is part of the selected motif.

Number of Motifs

Set the number of Motifs from 2 to 50. The initial number is 6.

Stitch

Type

Select Running or Triple stitch for stitching out the motifs.

Length

Set the Length of stitches from 1 to 20mm in steps of 0.1mm. Length is initially set to the recommended value for each motif.

Line Types

The following line types are available:

- Running Stitch
- Double Stitch
- Double Zigzag
- Triple Stitch
- Satin Line
- Motif Line

Running Stitch

Running stitch is a row of small stitches going forward. Running Stitch is also the preferred option for traveling stitches between sections of an embroidery.

Lines of running stitch are used for light markout or as underlay.



Set the stitch length

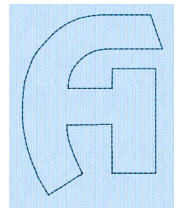

Note: Cutwork settings are dimmed as this stitch property is not available in mySewnet™ Embroidery.

Length

Set the Length of Running stitch from 0.3 to 12mm in steps of 0.1mm. The initial setting is 2mm.

Double Stitch

Double stitch is a row of small stitches going forward, followed by a row of small stitches going backward, so it ends at the same point where it began.

Double stitch is used for markout and for branching outlines that need to return to their starting points.

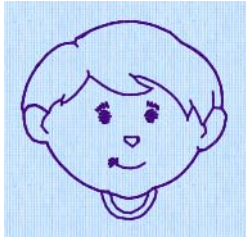

This Cartoons 2 SuperDesign uses Running Stitch, Double Stitch and Triple Stitch.

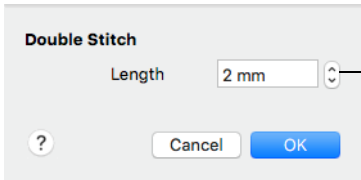

Set the stitch length

Length

Set the Length of Double stitch from 1 to 12mm in steps of 0.1mm.

The initial setting is 2mm.

Double Zigzag

Double Zigzag stitch is a row of small stitches going forward, followed by a zigzag row of small stitches going backward, so it ends at the same point where it began.

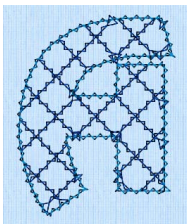

Crosshatch Fill, using Diamond style and an Angle of 45 degrees. Double Zigzag is the stitch used in the fill and for the border
(Revue Patchwork UC 50-120mm XH)

Note: Double Zigzag is a special stitch type, recommended for lace. A running stitch line is retraced in a zigzag pattern to create a mesh if sections are placed together. Alternatively, use this stitch type for crosshatch fill.

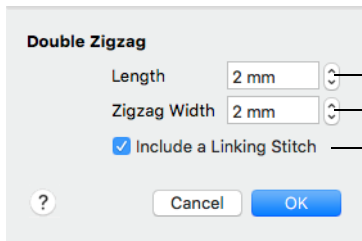

Set the stitch length

Set the width of the zigzag line

Use a linking stitch between sections of Double Zigzag

Length

Set the Length of Double Zigzag stitch from 1 to 12mm in steps of 0.1mm.

The initial setting is 2mm.

Zigzag Width

Set the Width of the Zigzag part of the stitch from 0.2 to 6mm in steps of 0.1mm.

The initial setting is 0.6mm.

Include a Linking Stitch

Use a linking stitch between sections of Double Zigzag.

Triple Stitch

Triple stitch is a row of small three-part stitches, each composed of one stitch going forward, one going backward then one going forward. The stitch length can be changed from 1mm to 12mm for individual lines in the properties dialog.



Use triple stitch for heavy markout or as heavy joining lines between sections of a character or SuperDesign.

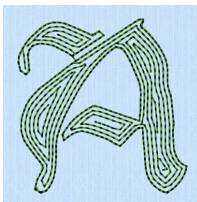

Contour Fill, using Triple Stitch and a 1.0mm gap, and with a Triple Stitch border.

(Per Gothic 25-120mm CF, Elegant category)

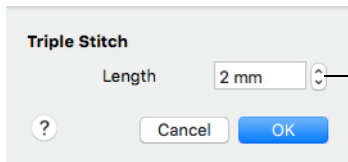

Set the stitch length

Length

Set the Length of Triple stitch from 1 to 12mm in steps of 0.1mm.

The initial setting is 2mm.

Satin Line

Satin Line is a line of constant-width satin stitch. It can be used alone, or as a border. The width of the line can be set from 1 to 12mm.

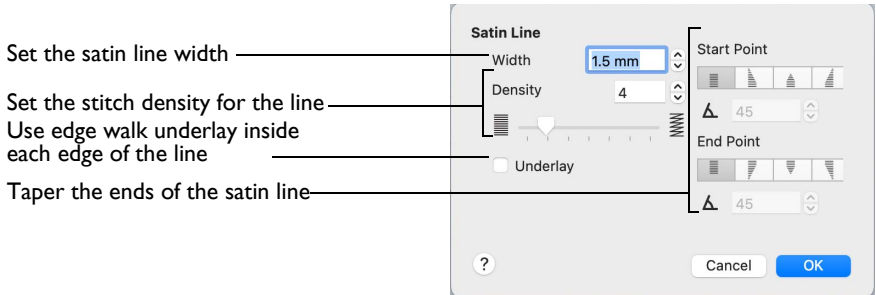
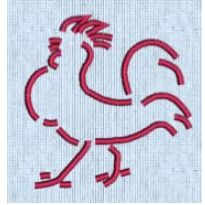

Width

Set Width for the satin line from 1 to 12mm. The initial setting is 4mm.

Density

Set Density from 2 to 15. The lower the number, the closer together the stitches and the more stitches are produced. The initial setting is 4.

Note: Embroidery on thicker fabrics usually looks better with more stitch coverage (a low density setting). Choose a low value such as 2 or 3 for heavy knit fabrics, and a higher value such as 5 or 6 for a light material like linen or satin.

Underlay

Use this option to place edge walk underlay inside each edge of the satin line.

Note: Underlay is not generated if the Width is set below 2mm.





Tapered Ends

The Start Point and End Point settings can be used to taper the ends of your satin lines.

Note: Use these options to create mitered or pointed ends for your satin lines.





Start Point

Use these options to change the type of line beginning for the satin line. Select a taper type, then set the Taper Angle Δ .

- No Taper 
- Left Taper 
- Central Point 
- Right Taper 

End Point

Use these options to change the type of line end for the satin line. Select a taper type, then set the Taper Angle Δ .

- No Taper 
- Left Taper 
- Central Point 
- Right Taper 

Motif Line

Motif line is used for decorative stitches and details. Use a motif line to frame an embroidery or monogram.

The example here enhances a flower embroidery with a Candlewicking Shield from the Frames category.



In the Motif Line dialog you can select motifs, and set the motif spacing, stitch type and length when creating a motif line.

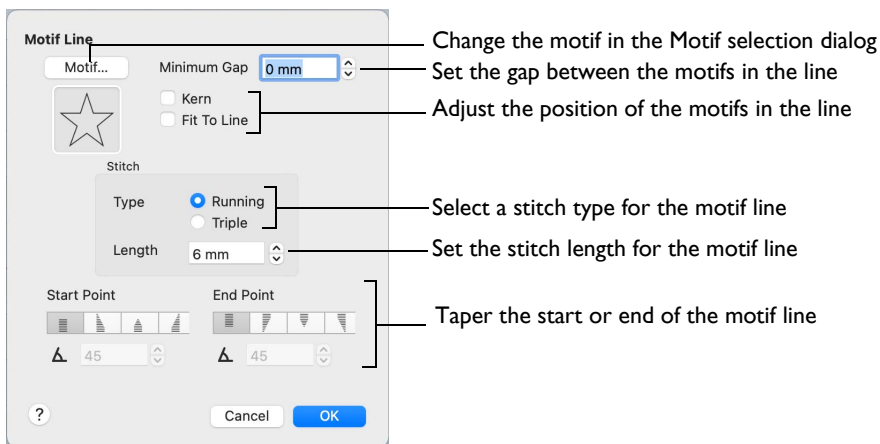

The Motif Line Properties dialog appears when you select a motif line.

Motif

Select a motif to use for the motif line.

- Click the Motif button to choose a motif. See “Motif Selection” on page 509.

Minimum Gap

This is the minimum amount of extra stitching that is placed between the motifs along the line. Minimum Gap is in addition to any spacing that is part of the selected motif.

Fit To Line

Select how the motifs follow the curves of the line.

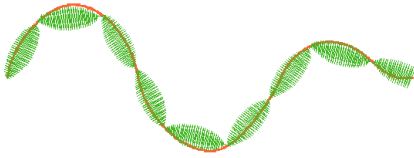

When Fit To Line is off, the ends of each motif are placed on the line.

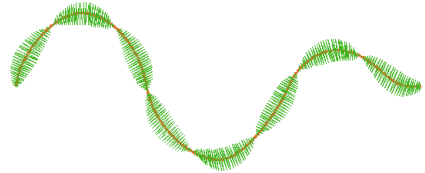

When Fit To Line is on, each whole motif is adjusted to fit along the line.

Kern

Kern automatically increases the space between adjacent motifs, so that the motifs fit along the line without overlapping.

Stitch

Select between Running and Triple stitch for stitching out the motif line.

Set the maximum stitch Length from 1 to 20mm in steps of 0.1mm.

Note: Length is initially set to the recommended value for each motif.

Tapered Ends

The Start Point and End Point settings can be used to taper the ends of your satin lines.

Note: Use these options to create mitered or pointed ends for your satin lines.

Start Point

Use these options to change the type of line beginning for the satin line. Select a taper type, then set the Taper Angle Δ .

- No Taper
- Left Taper
- Central Point
- Right Taper

End Point

Use these options to change the type of line end for the satin line. Select a taper type, then set the Taper Angle Δ .

- No Taper
- Left Taper
- Central Point
- Right Taper

Create a Motif Line Frame

- 1 Set the hoop size to 100mm x 100mm - Universal Square Hoop I. See "Hoop Selection" on page 22.
- 2 Choose File > Insert. See "Insert" on page 25.
- 3 Browse to mySewnet/Samples/Embroidery/Stitch.
- 4 Scroll down to "Floral Motif.vp4".
- 5 Click to load the embroidery into the work area.
The embroidery has blue or white handles on its selection box, depending on the Resize Mode.
- 6 Open the Frame window , and in Type select Frame .
- 7 Scroll down to the Frame set "Candlewick Shields I".
- 8 Click the frame in row 3, column 1.
This oval frame is designed to surround a landscape format embroidery.
- 9 In Surround, set Margin to 3.0 mm.
- 10 Deselect Group.



Note: The stitch type of a frame cannot be adjusted immediately after creation if Group is selected.

- 11 Click Apply. The frame is placed around the embroidery. It has green handles to indicate that it can be adjusted.
- 12 Control-click the frame and choose Motif Line to change the line properties.
- 13 Set the Minimum Gap to 2mm and click OK. There are now gaps between the motifs in the lines.
- 14 Control-click the frame and choose Motif Line to open the Motif Line properties dialog again.

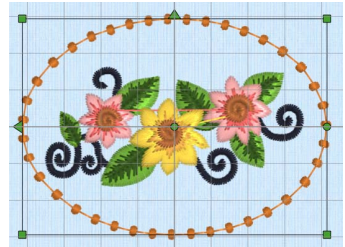

- 15 Try out the effect of using Kern and Fit To Line.
- 16 Open the Motif Line dialog and set the Minimum Gap back to 0mm.
- 17 Click the Motif button.
- 18 In the Motif selection dialog, choose General Motifs I from the Category pop-up menu.
- 19 Select motif number 8.

20 Click OK twice to close the Motif selection and Motif Line dialogs. The frame shows the new motif, but it is large, and overlaps the flower design.

- 21 Open the Motif Line and Motif selection dialogs again.
- 22 Ensure that Proportional is selected (the lock is closed ) .
- 23 Change the Height to 6mm (the Width changes at the same time).

24 Click OK twice to close the Motif selection and Motif Line dialogs. The motifs in the frame no longer touch the edge of the embroidery.

Note: Once you are happy with the appearance of the embroidery and frame, select both and click Group to keep them together.



Stitch Features

Motifs, gradients and fill patterns are used by more than one stitch type.

Motif Selection

Use the Motif selection dialog to select motifs for motif lines, underlines and fills, tapered motif columns, and as lines within a MultiWave Fill.

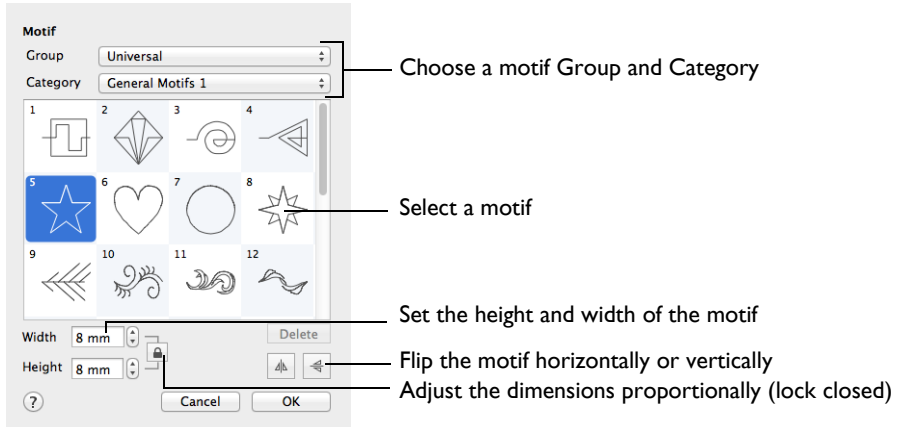

Note: Some functions may be dimmed with certain line or fill types.

Group

In the Group pop-up menu choose the desired group of motif patterns.

Category

In the Category pop-up menu choose the desired category of motif patterns.

Pattern

Select the desired motif visually. Motifs are numbered for convenient reference.

Height and Width

The Height and Width are initially set according to the chosen motif. The maximum and minimum values for Height and Width are individual to each motif.

Proportional

Use Proportional  to keep the relative Height and Width in proportion when either is changed.



Flip Horizontal

Use Flip Horizontal  to reverse the direction of the motif along the line of motifs. Some motifs are symmetrical and will have no apparent change when they are reversed.

Flip Vertical

Use Flip Vertical  to mirror the motif along the motif line. Some motifs are symmetrical and will have no apparent change when they are mirrored.

Selecting a Motif

- 1 In the Motif Fill, Motif Line or Shape Fill dialog, click the Motif (1 or 2) button.
- 2 Choose a Group from the pop-up menu.
- 3 Choose a motif Category from the pop-up menu.
- 4 Select a motif.
- 5 Set the Width and Height for the motif. If desired, select Proportional to change the Height and Width ratio. The button will change from a closed  to an open  lock.
- 6 Use Flip Horizontal or Flip Vertical to mirror the motif horizontally or vertically.
Note: When creating a Motif Fill, you can set Motif 1 and Motif 2 so that the motif is reversed on alternate lines.
- 7 Click OK to use your selected motif.

Fill and Satin Patterns

Set the Fill Pattern number for fill areas, satin areas and columns. When a pattern fill area is first created, for example by converting from another stitch type, the initial setting is pattern 3. Standard satin uses Pattern 0, which is not available for Pattern Fill areas.

- Patterns in categories other than Standard are recommended for use in relatively large fill areas, as they have repeating patterns which work well when 'tiled' together. Pattern 36 produces a 'satin effect' fill stitch.
- The first four patterns in the Gradient & Lace category (253-256) are recommended for multicolor gradient.
- Patterns 257 to 264 provide banded fill patterns that combine with crosshatch parallel fills to create a weave effect for lace designs. Set Spacing for the parallel fill at 2.4mm to combine with Pattern 257, 2.8mm to combine with Pattern 258, and so on.

Animals I — Patterns 37 to 48



Arrows — Patterns 49 to 60

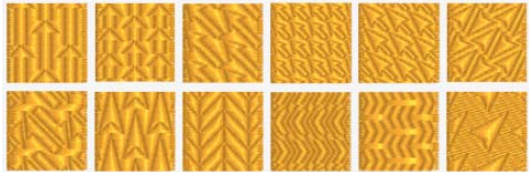

Circles I — Patterns 61 to 72

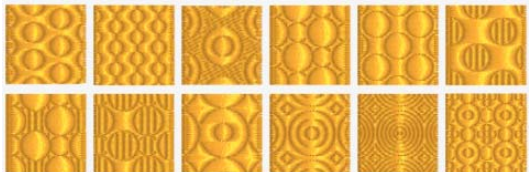

Circles 2 — Patterns 73 to 84

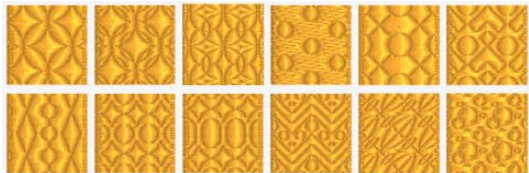

Climate — Patterns 85 to 96

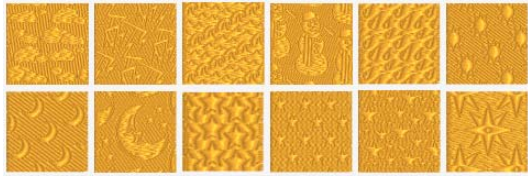

Diamonds — Patterns 97 to 108

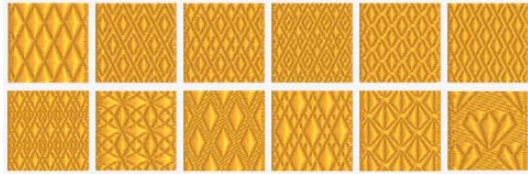

Gradient & Lace —
Patterns 253 to 264

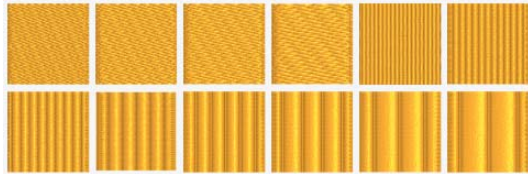

Hearts — Patterns 109 to 120

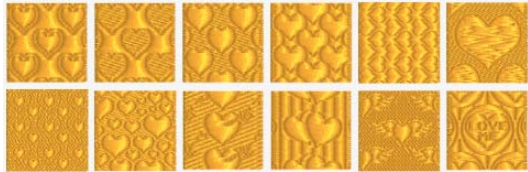

Leisure I — Patterns 121 to 132



Mosaic I — Patterns 133 to 144

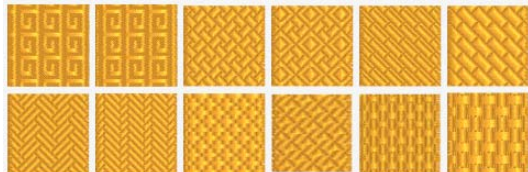

Mosaic 2 — Patterns 265 to 276

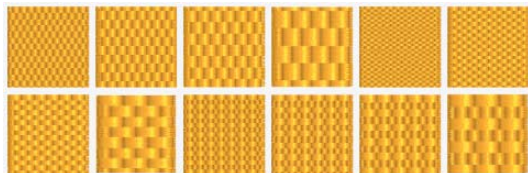

People — Patterns 145 to 156

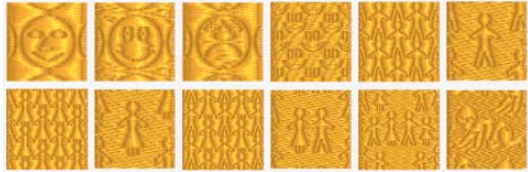

Plants & Flowers I —
Patterns 157 to 168

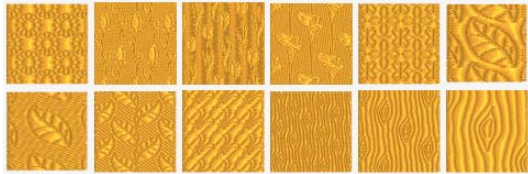

Polygons — Patterns 169 to 180

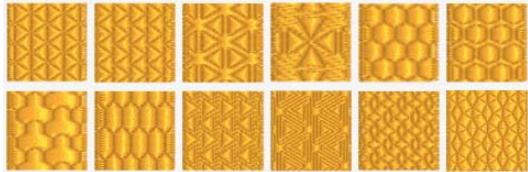

Rope & Chains —
Patterns 181 to 192

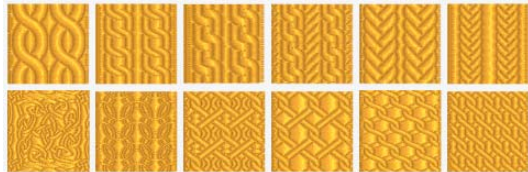

Squares I — Patterns 193 to
204

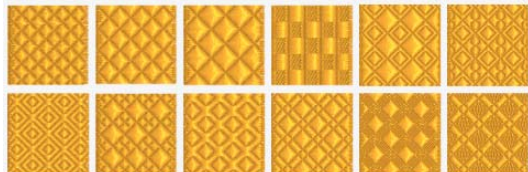

Squares 2 — Patterns 205 to
216

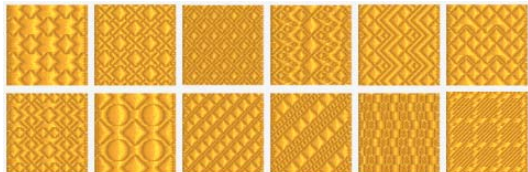

Standard I — Patterns 1 to 12

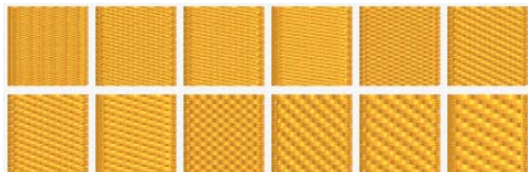

Standard 2 — Patterns 13 to 24

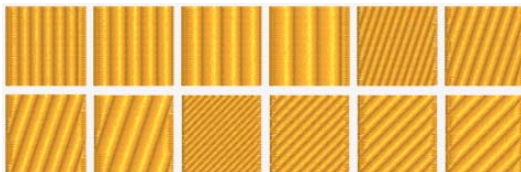

Standard 3 — Patterns 25 to 36



Transport — Patterns 217 to 228



Waves I — Patterns 229 to 240

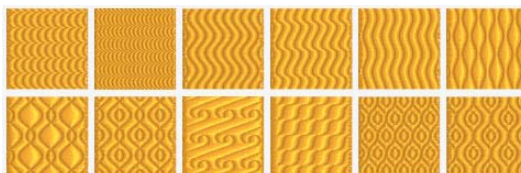

Waves 2 — Patterns 241 to 252

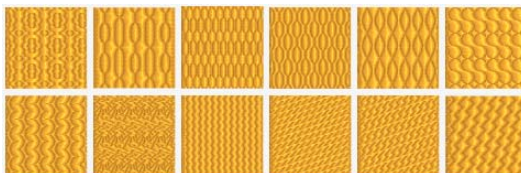

Use Preferences to set the grid size and choose overlap options. When these are changed, the new settings are remembered when mySewnet™ Embroidery is closed and reopened.

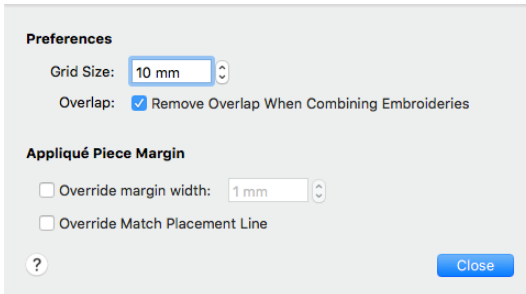

To open Preferences

- Choose mySewnet™ Embroidery > Preferences.
- Press ⌘,

Grid Size

Set the grid size between 2mm and 50mm, depending on what setting is most suitable for your screen resolution and embroideries. The initial setting is 10mm.

- Click the arrows for height and width to change the grid size. Alternatively, enter a size in the number box.

Overlap: Remove Overlap When Combining Embroideries

When this option is selected, overlapping areas of embroidery are removed, so that there is no build-up of stitching where embroideries overlap. This is used for the Combine All and Combine Selected functions, and when the Endless Embroidery dialog is used.

This option is initially selected.

Remove Overlap and Split on Combine

When Remove Overlap is selected, the overlap is removed before any split is determined. Occasionally this may mean that embroideries are not split because, after removing the overlap, they fit entirely in one stitch area of the hoop.

Some multipart embroideries are created with areas that are designed to overlap each other near the mid-section of the hoop. When viewing these designs in mySewnet™ Embroidery, deselect Remove Overlap in Preferences before sending them to the embroidery machine.

Appliqué Piece Margin

Use the Appliqué Piece Margin settings in Preferences to override the initial appliqué placement settings for lettering, SuperDesigns, Frames and Flourishes.

See “Appliqué Selection” on page 195 for more information on using appliqué placement margin and Match Placement Line.

Override margin width

Override the appliqué placement margin for the selected design, using the width set here instead. Set the margin for appliqué placement relative to the selected shape from -10mm to 10mm.

If you prefer always to use a certain value margin width for your automated cutter, set it here.

Override Match Placement Line

Override the setting for Match Placement Line in the selected design.

If you prefer always to match the placement line to the appliqué margin; for example to ensure the placement line is visible when positioning precisely cut pieces, choose this setting.

Use the Print dialog to select your print settings, and to print a worksheet for your embroidery.

To open the Print dialog

- Choose File > Print
- Press ⌘P

Print

Select Show Details to choose the information to be printed with the embroidery, select the printer and page layout, and choose a scale for the printout. Then print the embroidery worksheet.

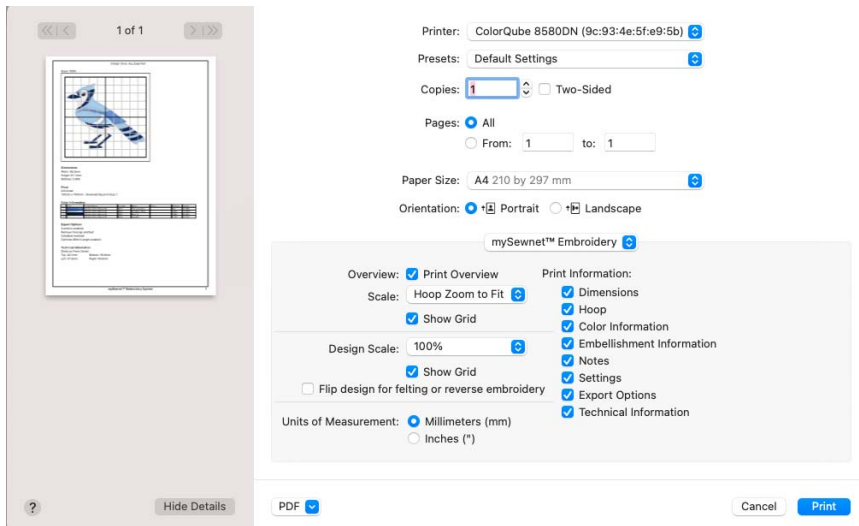

Note: If the embroidery is not within the hoop, or is too large for the hoop, a message is displayed instead of the Print dialog. Change the hoop size, or adjust the embroidery so that it fits in the hoop.

Preview

Display the active embroidery as it would appear when printed. Other information, such as the Dimension, Color Information, Notes and Settings and Technical Information is shown, depending on the choices made in the Print dialog. Export options such as Combine, Remove Overlap, ColorSort and Optimize Stitch Length are shown, depending on the choices made in the Export dialog. See “Export” on page 33.

If there are multiple pages, step through them with Next Page ► and Previous Page ◀.

Scale and Information

Select the information to be printed with the embroidery, such as the Dimensions, Color Information, Notes and Technical Information. In addition, the scale may be altered and a grid turned on or off. Set the Units of Measurement for the Dimensions and Technical Information to mm or inches, as desired.

Overview

Print Overview: Set this option to print all embroideries in a multipart hoop, multipart embroideries when Combine is not selected in Export, or the embroidery and project background.

Overview Scale: Select Hoop 100%, Hoop to Fit, Background to 100% or Background to Fit scaling when printing your overview.

Show Grid: This determines whether or not a grid is printed with the overview.

Design Scale

Scale: Select 25%, 50%, 75% or 100%, or To Fit scaling when printing your embroidery. This is how large the embroidery will print compared to the real size of a stitched out embroidery. Use a reduced Design Scale if you want to ensure that the worksheet fits on one page. Use the preview to see how many pages will be printed.

Show Grid: This determines whether or not a grid is printed with the embroidery. If you turn this off you will still get a rectangle representing the hoop.

Print Information

This determines what additional information is printed. Select the information to be printed with the embroidery, such as the Dimensions, Color Information, Notes and Technical Information. All items are selected initially.

Dimensions: The size of the embroidery and the stitch count.

Color Information: The sequence of thread colors used and, if available, the thread specification (range, thread number and name). Stop Commands and their messages (where present) are also shown.

Notes: Any notes and settings that are included with the embroidery.

Technical Information: The distance of each edge of the embroidery from the center of the embroidery.

Units of Measurement

Set the Units of Measurement for the Dimensions and Technical Information to mm or inches, as desired.

PDF

Choose PDF creation settings.

Hide Details

View a concise version of the Print dialog.

Printer

Select the printer you want to use.

Presets

Choose a saved printer setup.

Copies

Select the number of Copies you wish to print, and whether to print on two sides.

Pages

Select the range of pages you wish to print.

Paper Size

Select the size of paper that the embroidery is to be printed on.

Orientation

Choose Portrait or Landscape. Generally, you should not need Landscape for the standard hoop sizes as the embroidery is rotated automatically by the print process when you print an embroidery that uses a Horizontal hoop.

Settings Menu

Select the settings details for the following from the pop-up menu under the app name:

- Layout
- Color Matching
- Paper Handling
- Paper Feed
- Cover Page
- Supply Levels

Layout

Choose the number of pages per sheet, whether to use a border, and whether to print on two sides, reverse the page orientation, and flip horizontally.

Color Matching

Select the color match profile.

Paper Handling

Select page order, whether to collate pages, which pages to print, and scale relative to paper size.

Paper Feed

Select your paper source.

Error Messages

Opening the App

Loading Embroideries

"The file doesn't exist."

This message appears if the desired embroidery is not where the app expects it to be, for example if an embroidery was saved to a network drive, then deleted or renamed. The message would appear if you tried to load the embroidery from the Open Recent list on the File menu.

"Unrecognized file format."

This message appears if the embroidery you are attempting to load is corrupt. For example, it might have the extension .vp4, yet not be a proper Husqvarna Viking / Pfaff embroidery.

"Not enough memory available to perform function."

This message may appear if the embroidery you are attempting to load is corrupt. For example, it might have the extension .vp4, yet not be a proper Husqvarna Viking / Pfaff embroidery.

"Cannot open stitch file."

This message may appear if the embroidery you are attempting to load is corrupt. For example, it might have the extension .vp4, yet not be a proper Husqvarna Viking / Pfaff embroidery.

"Unrecognized file extension."

This message may appear if the embroidery you are attempting to load is corrupt. For example, it might have the extension .vp4, yet not be a proper Husqvarna Viking / Pfaff embroidery.

"Stitch file is corrupt."

The embroidery is corrupt and cannot be loaded. Refer to source of this file for a solution.

"Embroidery is corrupt."

The embroidery is corrupt and cannot be loaded. Refer to source of this file for a solution.

"Stitch file XY coordinates incorrect."

The embroidery is corrupt and cannot be loaded. Refer to source of this file for a solution.

"The document "xx" could not be opened."

This message appears if the embroidery you are attempting to load is corrupt. For example, it might have the extension .vp4, yet not be a proper Husqvarna Viking / Pfaff embroidery.

"The file "xx" is locked. If you want to make changes to this document, click Unlock. To keep the file unchanged and work with a copy, click Duplicate."

This message appears when trying to edit an embroidery which is locked, or is on a read-only medium such as a CD-R. Unlock the embroidery before editing, or duplicate it, and then edit it, if it is on a read-only medium.

"The file "xx" is on a read-only volume and cannot be unlocked. You can duplicate this document and edit the duplicate."

This message appears when trying to unlock an embroidery which is on a read-only medium such as a CD-R. Duplicate it, then edit and save it.

Modifying Embroideries

"A group is selected. To modify one item, use Reveal Groups and then select the design you wish to modify."

This message is displayed if you click the Modify tab when a group is selected. Select the item within the group that you wish to edit individually after using Reveal Groups, then click the Modify tab again.

"Multiple items are selected. Please ensure only one item is selected."

This message is displayed if you click the Modify tab when several items are selected. Click the individual item that you wish to modify, or use the Tab key to step through the designs until the desired one is selected, then click the Modify tab again.

"A design must be selected to use the features of the Modify tab."

This message is displayed if you click the Modify tab when no item is selected. Select an item, then click the Modify tab again.

"This will fix your selected design as embroidery stitches. Do you wish to continue?"

This message is displayed if you click the Modify tab when a SuperDesign, Lettering, or frame is selected. When a design is fixed, the stitches are then created, and any further resizing may affect stitch density and length. The stitch properties, for example the density, pattern, angle or stitch length, may not be changed after it is fixed, and for lettering the font and text may not be changed. Only click OK if you wish that item to be fixed as stitches.

"Decorations cannot be edited using the features on the Modify tab."

This message is displayed if you click the Modify tab when decorations are selected. You cannot adjust decorations on the Modify tab.

"Pasting into the Modify tab will combine and fix as stitches all designs from the clipboard block."

This message is displayed if you copy designs to the clipboard block, and then attempt to paste them into the Modify tab. Only click OK if you wish the items to be fixed as stitches.

Using Stitch Types

"Delete this motif, are you sure?"

This message appears if you click Delete in the My Motifs part of the Motif window. These are motifs that you created. If you do not want to delete the selected motif, click No.

Note: The Delete button is dimmed when system motifs are used, or if only one motif is present in My Motifs.

"The value '*' is invalid. Please provide a valid value."

This message appears in the following circumstances:

- If the value entered in the Density box for Satin Line, Satin Area, Satin Column, Pattern Fill, MultiWave Fill, Shape Fill or Spiral Fill is not a number.

"The value * is too large. Please provide a valid value."

This message appears in the following circumstances:

- If the value entered in the Density box for Satin Line is above 15.
- If the value entered in the Density box for Satin Column, Satin Area, Pattern Fill, MultiWave Fill, Shape Fill or Spiral Fill is greater than 40.
- If the value entered in the Compensation box in the Satin Column, Satin Area or Pattern Fill dialog is greater than 30.
- If the value entered in the Angle box in the Pattern Fill, Crosshatch Fill, Curved Crosshatch Fill or Motif Fill dialog is greater than 360°.
- If the value entered in the Horizontal or Vertical Gap box in the Motif Fill dialog is greater than 100%.
- If the value entered in the Horizontal or Vertical Offset box in the Motif Fill dialog is greater than 50%.
- If the value entered in the Echo Lines box in the Echo Fill dialog is greater than 30.

"The value * is too small. Please provide a valid value."

This message appears in the following circumstances:

- If the value entered in the Density box for Satin Line, Satin Area, Satin Column, Pattern Fill, MultiWave Fill, Shape Fill or Spiral Fill is smaller than 2.

- If the value entered in the Compensation box in the Satin Column, Satin Area or Pattern Fill dialog is smaller than 0.
- If the value entered in the Angle box in the Pattern Fill, Crosshatch Fill, Curved Crosshatch Fill or Motif Fill dialog is smaller than 0°.
- If the value entered in the Horizontal or Vertical Gap box in the Motif Fill dialog is smaller than -50%.
- If the value entered in the Horizontal or Vertical Offset box in the Motif Fill dialog is smaller than -50%.

"The value '*mm' needs to be in the range 0.0 to 20 mm. Please provide a valid value."

This message appears if the size entered in the Minimum Gap box in the Motif Line dialog, or the Motif section of the MultiWave Fill or Shape Fill dialog is below 0mm or above 20mm.

"The value '*mm' needs to be in the range 0.2 to 5 mm. Please provide a valid value."

This message appears if the size entered in the Spacing box in the Contour Fill dialog is below 0.2mm or above 5mm, or is not a number.

"The value '*mm' needs to be in the range 0.2 to 6 mm. Please provide a valid value."

This message appears if the size entered in the Zigzag Width box in the Double Zigzag stitch dialog or the Crosshatch Fill dialog is below 0.1 mm or above 12mm, or is not a number.

"The value '*mm' needs to be in the range 0.3 to 12 mm. Please provide a valid value."

This message appears if the size entered in the Length box in the Running Stitch dialog is below 0.3mm or above 12mm, or is not a number.

"The value '*mm' needs to be in the range 1 to 5 mm. Please provide a valid value."

This message appears if the size entered in the Spacing box in the QuiltStipple Fill dialog is below 1mm or above 5mm, or is not a number.

"The value '*mm' needs to be in the range 1 to 12 mm. Please provide a valid value."

This message appears if the size entered in the Length box in the Double Stitch, Double Zigzag Stitch or Triple Stitch dialog, or the Stitch Length box in the MultiWave Fill, Motif Fill, Shape Fill, Crosshatch Fill, Curved Crosshatch Fill, Echo Fill, QuiltStipple Fill or Contour Fill dialog is below 1mm or above 12mm, or is not a number.

"The value '*mm' needs to be in the range 1 to 12 mm. Please provide a valid value."

This message appears if the size entered in the Width box in the Satin Line dialog is below 1mm or above 12mm, or is not a number.

"The value '*mm' needs to be in the range 1 to 20 mm. Please provide a valid value."

This message appears if the size entered in the Stitch Length box in the Motif Line dialog is below 1mm or above 20mm, or is not a number.

"The value '*mm' needs to be in the range 2 to 20 mm. Please provide a valid value."

This message appears if the size entered in the Spacing box in the Crosshatch Fill, Curved Crosshatch Fill or Echo Fill dialog is below 2mm or above 20mm, or is not a number.

Creating Lettering

"The value '*mm' needs to be in the range 3 to 200 mm. Please provide a valid value."

This message appears if the size entered in the Size Box on the Letter window of the Control Panel, or in the Letter Properties dialog is below 3mm or above 200mm, or is not a number. The Size setting refers to the height in millimeters of an uppercase 'A' in the selected font. If you wish to increase lettering above this you could drag one of the corner boxes or alter the Height or Width proportions.

"The value '*mm' needs to be in the range 1 to 5 mm. Please provide a valid value."

This message appears if the size entered in the Line Spacing box in the Letter Letter Options or Letter Properties dialog is below 1mm or above 5mm, or is not a number.

Creating SuperDesigns

"The value '* is invalid. Please provide a valid value."

This message appears if the value entered in the height or width box on the SuperDesign window of the Control Panel, or in the SuperDesign Properties dialog, is not a number.

"The value '*mm' needs to be in the range 5 to 200 mm. Please provide a valid value."

This message appears if the size entered in the Size Box on the SuperDesign window of the Control Panel, or in the SuperDesign Properties dialog, is below 5mm or above 200mm, or is not a number. The Size setting refers to the height in

millimeters of the selected SuperDesign. If you wish to increase the size above this you could drag one of the corner boxes or alter the Height or Width proportions.

"The value * is too small. Please provide a valid value."

This message appears if the value entered in the height or width box on the SuperDesign window of the Control Panel, or in the SuperDesign Properties dialog, is smaller than 25%.

"The value * is too large. Please provide a valid value."

This message appears if the value entered in the height or width box on the SuperDesign window of the Control Panel, or in the SuperDesign Properties dialog, is greater than 400%.

Creating Frames

"The value '*' is invalid. Please provide a valid value."

This message appears if the value entered in the height or width box in the Frame Options or Frame Properties dialog is not a number.

"The value '*mm' needs to be in the range 5 to 500 mm. Please provide a valid value."

This message appears if the size entered in the Size Box in the Frame Options or Frame Properties dialog is below 5mm or above 500mm, or is not a number. The Size setting refers to the height in millimeters of the selected Frame. If you wish to increase the size above this you could drag one of the corner boxes or alter the Height or Width proportions.

"The value '*mm' needs to be in the range -50 to 50 mm. Please provide a valid value."

This message appears if the size entered in the Margin box on the Frame window of the Control Panel is below -50mm or above 50mm.

Creating Borders and Motif Underlines

"The value '*mm' needs to be in the range -50 to 50 mm. Please provide a valid value."

This message appears if the size entered in the Margin box on the Border window of the Control Panel is below -50mm or above 50mm.

"The value '*mm' needs to be in the range 10 to 1,000 mm. Please provide a valid value."

This message appears if the size entered in the Length box in the Motif Underline section of the Border window is below 10mm or above 1000mm, or is not a number.

"The value * is too small. Please provide a valid value."

This message appears if the value entered in the Repeats box in the Motif Underline section of the Border window is smaller than 1.

"The value * is too large. Please provide a valid value."

This message appears if the value entered in the Repeats box in the Motif Underline section of the Border window is greater than 100.

"The value '*' is invalid. Please provide a valid value."

This message appears if the value entered in the Repeats box in the Motif Underline section of the Border window is not a number.

Creating a Font with the QuickFont

"XX already exists. Do you want to replace it?"

This message appears if a font you are trying to create has a name that has already been used. Replace the existing font, or choose a new name before you continue.

Using the ExpressDesign Assistant

"Some areas were too thick to be traced."

This message may appear when creating a Express Trace design if the final picture has thick areas of solid color. Some or all parts of the design may not be created. Try using options in the assistant, on the Outline Finder and Expander page and/or the Monochrome Threshold page, to ensure the outlines are not too thick. Cancel the assistant, adjust the picture so that the outlines are easier to isolate with Monochrome Threshold, then open the picture in the ExpressDesign Assistant again.

Using the PhotoStitch Assistant

"The selected dimensions will produce a large PhotoStitch and stitch creation may take some time. Transparent background areas will reduce the time required."

This message appears if you specify a PhotoStitch larger than 26000mm square. Click OK to continue creating the PhotoStitch. To reduce the stitch creation time, remove the picture background, particularly any very detailed areas.

Using My Demo in Life View

"Do you want to remove all points from your demo? This cannot be undone."

This message appears if you use Reset My Demo in Life View. Click Yes to continue, or No to keep your existing My Demo.

Saving or Embroidering Files

"The document "xx" could not be saved. No stitch data to save."

This message appears if there are no stitches in your embroidery. For instance, if you deleted the embroidery and then tried to save it.

"The document "xx" could not be saved as "xx". The volume is read only. Try saving the file to another volume."

This message appears if, for instance, you try to save an embroidery to a CD-R. A CD-R is read only, therefore you will not be able to save the embroidery. Save the embroidery to another medium.

"The document "xx" could not be autosaved. The volume is read only. Try saving the file to another volume. You can also duplicate the document or discard your changes to close it."

This message appears if, for instance, you have loaded an embroidery from a CD-R and then attempt to save the embroidery back to the CD. A CD-R is read only, therefore you will not be able to save the embroidery. Save the embroidery to another medium.

Exporting Embroideries or Sending Embroideries

"Embroidery is too large or not in the hoop."

This message appears if an embroidery you are trying to Export is outside the selected hoop or larger than will fit in it. For example, with the 100mm x 100mm hoop selected, an embroidery smaller than 100mm x 100mm might be placed partially outside the work area when you choose Export. This message would then appear. Move the embroidery completely within the four blue corners of the work area and try again. Alternatively, change the size of the hoop.

"The file already exists. Do you want to replace it?"

This message appears if an embroidery you are trying to Export has a name that has already been used. Replace the existing embroidery, or choose a new name before exporting.

"Exporting to XX failed."

This message appears if you cannot save the embroidery to the selected place, for example if you try to save to a CD-R, or to an incompatible drive.

"Exporting to XX failed. The design was too big for the export format."

Certain formats are limited to the number of stitches they can save or the size of hoop used on their specific embroidery machine, for example the .sew or Pfaff (.pcs) file format. If you attempt to save a file in this format that is bigger than the largest available hoop size, or has more stitches than are allowed, this message will appear.

Printing Embroideries

"Embroidery is too large or will not fit in hoop."

This message appears if the embroidery on screen is partially outside the selected hoop. Move the embroidery completely within the four blue corners of the work area and try again, or change the hoop size.

Miscellaneous

"Not enough memory available to perform function."

This message appears if system resources are low. Close other apps and try again. If this does not work, try restarting your computer.

"Could not understand the string XX."

This message appears if the value entered in a number box is outside the valid range, or is not a number.

Other Topics

Screen Appearance

"Some of the buttons in the Control Panel are dimmed."

Certain buttons (for example Modify Design and ColorSort in the Design window of the Control Panel) are only available once an embroidery is shown on the screen.

"Some of the items in a menu are dimmed."

Certain items (for example Design Player in the View menu) are only available once an embroidery is shown on the screen.

"I have changed grid color and spacing and now I wish to return to the original settings."

Use mySewnet™ Configure to change the grid color. Click the Color block and the Colors window appears to allow you to choose a color. The color set by default for your mySewnet™ Software is 127, 127, 127 (RGB). You can use the RGB Sliders in the Colors Sliders tab to return to this color.

Use Preferences to change the grid spacing. Set the Grid Size to 10mm.

"I have changed the screen background color and now I wish to return to the original light blue."



Use mySewnet™ Configure to change the screen background color. Click the Color block and the Colors window appears to allow you to choose a color. The color set by default for your mySewnet™ Software is 211, 233, 255 (RGB). You can use the RGB Sliders in the Colors Sliders tab to return to this color.

"I can't see the toolbar or some of the buttons."

Use Reset All Apps in mySewnet™ Configure to return the toolbar and windows in the app to their default settings.

To return the buttons in the toolbar to their default settings, choose View > Customize Toolbar, and drag the default button set into the toolbar.

To use Reset All Apps

- 1 Ensure your designs are saved in any mySewnet™ Embroidery Software apps that are open.
- 2 Click the mySewnet™ Configure icon in the Launchpad , or double-click the mySewnet™ Configure icon in the Finder .
- 3 Click the Utilities tab.
- 4 Click Reset All Apps.
- 5 Click the Quit Open mySewnet™ Apps button to close all open apps.
- 6 Click the Reset All Apps button.

Note: If some mySewnet™ apps are still open, a message appears, saying that some apps appear to be running. Click OK to close all running mySewnet™ apps, or click Cancel. The toolbar and windows in your app will have been restored to their original state.

Note: If preferred, to check the toolbar choose View, then choose Show Toolbar if the toolbar has been hidden, or choose Customize Toolbar to reset the toolbar if buttons have been added to or removed from the toolbar. If this does not restore the toolbar, use Reset All Apps.

Life View

"How do I backup a My Demo animation?"

The My Demo animated preview is stored in the AnimationPath.txt file in the folder /[User]/Library/ApplicationSupport/mySewnet/EmbroideryI/System. This location may not be visible on your Mac®, but you can find it using the following steps.

To Backup a My Demo Animation

- 1 Open the Finder window.
- 2 Open the Go menu.
- 3 Hold down the Option (Alt) key, and choose Library.
- 4 Browse to /ApplicationSupport/mySewnet/EmbroideryI/System.
- 5 Copy the file AnimationPath.txt to your backup location.

Loading Embroideries

"I cannot open Melco (.exp) files in mySewnet™ Embroidery."

The Melco format extension (.exp) is used by default in the Mac operating system for system files, so you cannot use the Open dialog to load Melco files. Use Insert to load Melco designs in your mySewnet™ Embroidery Software.

Working with Embroideries

"The embroidery I want to work with appears too small on the screen."

Make sure the mySewnet™ Embroidery window is maximized by choosing Window > Zoom. Click Zoom To Fit to expand the hoop so it fills the work area. Also, choose a Hoop Size in Hoop Selection that is suitable to the embroidery size.

"I find it hard to select the embroidery I wish to edit."

Many functions of mySewnet™ Embroidery can be used to help see embroideries more easily. They include the Zoom slider and the different methods of selection (Box Select, Freehand Select and Point Select). Use Command and the left or right arrow (⌘← or ⌘→) to select each embroidery in turn.

"Certain functions don't seem to work all the time."

Some functions, such as the alignment tools, are only available when one or more embroideries are selected. To use these functions, select one or more embroideries first.

"I've selected the wrong embroidery to move or manipulate."

To deselect an embroidery, click the outside the embroidery, or on another embroidery. To select the desired embroidery, click on it and an outline box appears. If one embroidery or piece of lettering is overlapping another making it difficult to select, use Command and the left or right arrow (⌘← or ⌘→) to select each embroidery in turn.

"The Color Select area on the Design window appears blank."

If no design is selected, or more than one design is selected, the Color Select area on the Design window will be blank. To change the threads in an embroidery, select the single embroidery, then view the threads in the Color Select area.

"I did not select all the embroideries I wanted with Box, Freehand or Point Select."

The embroideries must be fully enclosed by the selection line to be selected as part of a block. If even the smallest part of an embroidery is outside the line, then it will not be selected.

Choosing Thread Colors

"When I try to use the number box to select a thread number, the wrong thread shade is selected."

The find thread feature in Color Selection allows you to enter partial thread numbers. The first thread in the list matching the number is found, with priority given to an exact match. The existing thread number is also listed. If you are attempting to find a thread with only part of the number, the first thread matched may not be the desired thread. To ensure you select the correct thread, enter the thread number as it appears in the list. Some thread ranges have prefix characters on the thread number. These must also be entered to obtain an exact match.

"A thread in an embroidery from a friend had a different name or number when I first opened it."

The thread name or number is changed when the thread is opened if the Thread Range of the selected color is not found in your thread database. This could happen if the design you are attempting to edit was supplied by someone with a later version of the thread database. The color is replaced with the nearest match in the Import Thread Range you have set in mySewnet™ Configure. You can alter it to any other color if desired. To check for the latest updates for the mySewnet™ Embroidery Software, use Smart Update in mySewnet™ Configure.

Using QuickFont

"How do I back My Fonts?"

Your My Fonts are stored in the folder /[User]/Library/ApplicationSupport/VSMSoftware/mySewnet/Fonts/My Fonts. This location may not be visible on your Mac®, but you can find it using the following steps.

To Backup your My Fonts folder

- 1 Open the Finder window.
- 2 Open the Go menu.
- 3 Hold down the Option (Alt) key, and choose Library.
- 4 Browse to /ApplicationSupport/VSMSoftware/mySewnet/Fonts/My Fonts.
- 5 Copy your fonts to your backup location.

Using the ExpressDesign Assistant

"When I open a picture the name is displayed, but I cannot see the picture and Continue is dimmed."

This can happen if the desired picture is corrupt. For example, it might have an extension such as .bmp or .jpg, yet not be a proper picture file.

"My picture already has outlines, but some outlines are not traced properly when I create an Express Trace embroidery."

This can happen if the outlines in your original picture are only one pixel wide. For example, there may be gaps or missing sections of the outline. If this happens, select Find Outlines on the Outline Finder and Expander page and ensure Expand is set to 1. This will thicken all the outlines so that they are traced correctly.

"The preview picture is blank or almost blank on the Express Trace Options or Express Border Options page."

This may happen if the outlines in the picture are only one pixel wide after the Monochrome Threshold page.

For Express Trace, return to the Outline Finder and Expander page, select Find Outlines and ensure Expand is set to 1.

For Express Border, first click Picture Options and set the Area Sensitivity to High. If this does not have the desired effect, return to the Monochrome Threshold page and adjust the slider so that more of the picture within the desired areas turns black. If this also selects unwanted parts of the picture, you may need to remove the unwanted areas in a picture editor.

"My picture only makes a rectangular border when I create an Express Border."

This can happen with a picture that has a border or background that is black or very dark, especially if the background or border cannot be removed with Monochrome Threshold.

For pictures with a dark border, it should be possible to remove the border on the Crop Picture page of the ExpressDesign Assistant. If this is not possible, edit the picture to remove the border or change the border color.

For pictures on a dark background, use an image editor to invert the colors in the picture or change the background color to a light color.

After editing the picture, load it again in the ExpressDesign Assistant.

Linear PhotoStitch Embroideries

"I would like to get rid of the lines created from the white background of my picture by Linear PhotoStitch embroidery."

After creating and saving an embroidery, use the Edit tab or open the file in mySewnet™ Stitch Editor and use the following instructions.

- 1 Use the Freehand Block Select feature to mark the stitches in the background.
- 2 Click Delete Stitches.
- 3 Save the adjusted embroidery.

Using the ExpressMonogram Assistant

"I have used a motif as an envelope border and the results are unexpected."

If the selected motif width is larger than the size of the monogram or name, then only one motif may be created. Adjusting lettering or motif size or spacing may allow multiple motifs to be included in the border. If the selected motif shape is irregular it may overlap the monogram. Adjusting lettering or motif size or spacing may produce the desired results.

Encore

"I want to change the design that has been used in the corners in Encore."

In Encore Shape and Encore Hoop, when two embroideries are selected, the embroidery that is first in the stitchout order is placed in the corners. If you want to use the other embroidery in the corners, use Layout Order to change the order.

"Not all of my designs have been used in the Encore function."

A maximum of two designs can be used with Encore Shape and Encore Hoop. If more than two designs are selected, only the first two that were loaded will be used in the Encore. Either use Encore Circle or Line, or combine some of the embroideries before using Encore.

"The Mirror option does not seem to have any effect."

If your embroidery is horizontally symmetrical before you use the Encore function, the Mirror option will have no apparent effect. However, it will affect stitch order of each alternate copy. For example, clockwise stitching will become counter-clockwise, and so on.

Using the Endless Embroidery Dialog

"How can I tell if an embroidery is already endless?"

The Notes for an embroidery will have the word Endless added after any other Notes text. If the Notes have been edited so that this is no longer the case, use the slider bars on the Modify window to see if there are marker stitches at the beginning and end of the embroidery.

"I have loaded an embroidery that I made Endless some time ago. How do I know what Fabric Direction was used when I made it endless?"

Use the slider bars on the Modify window to find the locations of the start and end marker stitches. For example, if the start markers are at the top and the end markers are at the bottom, the original Fabric Direction was Up.

"I forgot to set a Gap, but it does not appear to have worked when I tried to make the embroidery Endless again."

This can happen if you use the Repeat Embroidery option and you do not use Undo before trying again. This is because you have already created a repeated sequence with no gaps that then becomes a single embroidery. If you then use the Endless Embroidery dialog again to try to add a Gap, the whole repeated sequence is treated as a single embroidery. This should be apparent if you look at the Notes, because the word 'Endless' will occur twice at the end of the Notes. Always use Undo to go back to the single copy of the embroidery before trying Endless again with different settings.

"The Endless Embroidery dialog does not work."

The Endless Embroidery dialog is not available in any of the following situations:

- There is no embroidery loaded, so there is nothing that can be made endless: load an embroidery
- The embroidery is too big for or is outside the current hoop: adjust the embroidery as needed or choose a larger hoop

Lettering, SuperDesigns and Frames

"I don't remember which font I used when making an embroidery."

Information on the font, SuperDesign, Frame or Border used in an embroidery made in mySewnet™ Embroidery is stored in the Settings. Open the embroidery, then click the Settings tab and Edit in the Design window to view the full text of the settings. Alternatively, print a worksheet for the embroidery.

"I want to change the size of the lettering, but the control boxes have no effect."

For the following Lettering Shapes, there are no control boxes to change the size of the characters in the lettering:

- Circle Clockwise
- Circle Clockwise
- Full Circle
- Fit To Straight Line
- Fit To Wavy Line

Instead, use Size, Height and Width in Letter Properties to change the size of the characters.

"I want to change the appearance of the font stitching, but the Stitch Type pop-up menu is not available."

Some fonts have non-editable properties. For example, they may use more than one pattern for satin or fill, or use the same fill pattern at different angles in different characters. Therefore, there is no overall uniform property that can be changed, so the properties dialog may not be used to change the stitch Properties. You may wish to use a different font with a similar style that allows you to change its properties.

"When I try to change the stitch properties the Stitch Type pop-up menu is dimmed (unavailable)."

You are trying to change a property in a font that is not editable. For instance, if a font uses more than one type of Pattern Fill, the stitch type will be unavailable. Also, if a font is an outline font of running, double or triple stitch, no fill or satin properties will be available.

"I have increased the Gap setting, but the lowercase characters are still touching each other."

For script fonts, the Gap setting has no effect on adjacent lowercase characters. Script fonts use a special 'continuous' joining method, which places lowercase characters adjacent to each other to give the appearance of handwriting. All the fonts in the Script category use this joining method.

"All the lettering appears in uppercase, even though I have entered lowercase characters in the Letters box."

You are using an uppercase font. In an uppercase font (with UC in the name), all the lowercase characters are identical to the uppercase characters.

"All the lettering appears in lowercase, even though I have entered uppercase characters in the Letters box."

You are using a lowercase font. In a lowercase font (with LC in the name), all the uppercase characters are identical to the lowercase characters.

"I have placed multiple pieces of lettering with different text in each item and I want to change the text that appears in some of them. However, the text in the Letters box stays the same when I select earlier pieces of lettering."

Select the desired lettering, then Control-click the lettering and choose Properties. The Letter Properties appears and you may change the text.

Note: Once lettering has been converted to embroidery when it is Combined or Fixed as Stitches, no adjustments can be made with Letter Properties.

"When I use a Script font with the Full Circle lettering shape, the characters are not arranged correctly."

Script fonts use a special connection method that allows adjacent lower case letters to be connected to each other, regardless of the Gap setting. This is not compatible with the way the characters are arranged by the Full Circle lettering shape.

Note: Circle Clockwise and Circle Counter-Clockwise are compatible with Script fonts.

"I have adjusted my lettering on the work area, but when I change the Letter Properties, the lettering changes shape a little."

The control boxes on blocks of lettering allow subtle adjustments directly to the shape of the lettering. However, the Letter Properties only allows the proportions of Height and Width to be adjusted. When the Letter Properties are changed, the previous adjustments may be partially lost when the Height and Width values are applied. Therefore, it is recommended to make all desired adjustments in Letter Properties before making final adjustments directly with the control boxes.

"In Letter Options I tried to edit the Stitch Type for my lettering, but the pop-up menu was dimmed."

If a font does not use an editable stitch type, the Stitch Type will not be available in Letter Options.

"In Letter Properties I tried to edit the Stitch Type for my lettering, but there was no pop-up menu."

Stitch types are not available in the Letter Properties dialog. Control-click the lettering, and select the stitch type from the context menu.

"I used Control-click to open the context menu for my lettering, but I could not choose the stitch type."

If a font does not use an editable stitch type, no stitch type will be available in the context menu.

Using Import Font from Embroideries

"How do I create an apostrophe or quotes?"

If your set of letters includes a comma, load it as the apostrophe, then move the Baseline so that it is on or just below the red dashed top line. For quotes, copy and flip the comma before loading as single and double quotes.

You can also use mySewnet™ Stitch Editor to add accents to existing characters, and create other punctuation symbols.

"My apostrophe overlaps another letter when placed as lettering."

When loading letters for a font, the apostrophe and quotes may kern better if they are placed further down from the red dashed top line.

Alternatively, use Horizontal Block with the Individual option to be able to fully adjust the lettering after placing it in the work area.

Multipart Hoops

"The alignment stitches for the second part of a design seem to have disappeared."

Some multipart embroideries are created with alignment stitches that overlap exactly. When viewing these designs in mySewnet™ Embroidery, deselect Remove Overlap in mySewnet™ Configure, Export, before sending them to the embroidery machine.

Cancelling unwanted actions

"I changed a color in my embroidery, but do not like the new color. Undo is dimmed on the Edit menu so I can't choose it."

To cancel some actions, click outside the currently active embroidery. Then choose Undo. Alternatively, Control-click the embroidery and choose Undo from the context menu.

ColorSorting Files

"When I ColorSort an embroidery the number of color blocks produced varies."



The ColorSort process does not just put the same color blocks together. It checks for overlap between areas. Therefore depending on the overlaps, the final number of color blocks may vary, even if you have Combined exactly the same embroideries, lettering or SuperDesigns.

Sending Files

"I cannot send a file to my embroidery machine."

First, confirm that the mySewnet™ Connect app is running. mySewnet™ Connect appears as a machine icon  in the menu bar.

If mySewnet™ Connect is not running, start it.

- Click the mySewnet™ Connect icon in the Launchpad , or double-click the mySewnet™ Connect icon in the Finder .

Second, confirm that the mySewnet™ Connect app is communicating with your embroidery machine.

Menus

mySewnet™ Embroidery Menu

	About mySewnet™ Embroidery	Display app information, version number and copyright.
⌘,	Preferences	Set the grid size and choose overlap options.
	Configure	Configure your mySewnet™ Embroidery Software.
	Check for updates...	Check for updates to your mySewnet™ Embroidery Software.
	Services	
⌘H	Hide mySewnet™ Embroidery	Hide the current app.
⇧⌘H	Hide Others	Hide other apps.
	Show All	Show all apps.
⌘Q	Quit mySewnet™ Embroidery	Exit the app.
⇧⌘Q		Quit and Close All Windows Exit the app and close all windows.

File Menu

⌘N	New	Open a new window with no embroideries on the screen.
⌘O	Open	Open an existing embroidery.
	Open Recent	Open recently used embroideries.
⌘I	Insert	Load a saved embroidery into an existing window.
⌘W	Close	Close the current window.
⇧⌘W		Close All Close all open windows. (Press Option when viewing the menu to see this function.)
⌘S	Save	Save the contents of the window as a multipart embroidery in .vp4 format.
⇧⌘S	Duplicate	Make a copy of the embroidery in the current window under a new name.
⇧⇧⌘S		Save As Save the contents of the window as a multipart embroidery in .vp4 format under a new name. (Press Option when viewing the menu to see this function.)
	Rename	Rename the document in the currently selected window.

	Move To	Move a document from the folder it is saved in, to another folder.
	Revert To	Return to a previous version of your embroidery.
⌘S	Export	Save the embroidery in the current window as a flattened .vp4 file, or in an alternative embroidery format.
	Export Appliqué Pieces	Save or print appliqué outlines ready for cutting by a fabric cutter or INSPIRA™ Cutwork Needles.
	Export Decoration Template	Save a template for all your decorations in a format for your cutter, to create a crystal transfer template.
⌘P	Print	Set printing options, preview and print the selected embroidery(ies) and background.
⌘1	Send	Send the selected embroidery to the mySewnet™ Cloud, or to the connected machine or computer.

Edit Menu

⌘Z	Undo	Reverse the last action.
⇧⌘Z	Redo	Reverse the last action that was undone by Undo.
⌘X	Cut	Delete the selected embroidery or block of stitches from the screen and place it on the clipboard.
⌘C	Copy	Make a copy of the selected embroidery or block of stitches and place it on the clipboard.
⌘V	Paste	Paste an embroidery or block that has been cut or copied to the clipboard onto the screen.
⌘⇧V	Paste into Center	Paste an embroidery or block that has been cut or copied to the clipboard into the center of the screen.
⌘D	Duplicate Selected	Make a copy of the whole embroidery or block which is automatically pasted on the work area.
⌘⌫	Delete	Remove the selected embroidery or block of stitches from the screen without moving it to the clipboard.
⌘R	Resize Mode	Switch between resize and scale.
	Box Select	Drag to select embroideries or stitches in a rectangular area.
	Freehand Select	Draw a line to select embroideries or stitches within an area of any shape.
	Point Select	Select embroideries or stitches within an area of any shape made of straight and curved lines, defined by a series of points.
	Select Stitches	Select and edit single stitches.
⌘A	Select All Visible	Select all of the embroideries or stitches in the work area, including any that are outside the hoop.
⇧⌘A	Deselect All	Deselect every selected embroidery or stitch, including any that are outside the hoop.
	Select Mode	
		Replace Selection Replace the currently selected embroideries with the new selection.
		Add To Selection Add the new selection to the currently selected embroideries.
		Remove From Selection Remove the new selection from the currently selected embroideries.
⌘←	Previous Design	Select the previous design in the stitchout order.
⌘→	Next Design	Select the next design in the stitchout order.
	Modify	

	Insert Color Change	Add a new color change at the point where you click.
	Insert Stop	Add a command which instructs the embroidery machine to stop at the point where you click.
	Insert Trim	Add a command which instructs some embroidery machines to cut the thread.
	Insert Stitches	Add new stitches to the embroidery at the point where you click.
	Insert Tie-On Stitch	Add a tie stitch at the beginning of the stitch area to be secured.
	Insert Tie-Off Stitch	Add a tie stitch at the end of the stitch area to be secured.
	Delete Commands	Delete an unwanted Color Change, Stop or Trim command.
	Hoop	Select the desired hoop size.
	Spelling and Grammar	
⌘:		Show Spelling and Grammar
⌘;		Check Document Now
		Check Spelling While Typing
		Correct Spelling Automatically
fn fn	Start Dictation	Use your voice instead of typing into a text field.
^⌘ Space	Emoji and Symbols	Select symbols or characters from the Characters dialog, for example to enter into the Notes.

View Menu

⌘.	Grid	Turn the background grid on and off.
⇧⌘K	Load Background	Start the Background Assistant to preview embroideries on a garment, quilt block or fabric.
	Background Visibility	
⌘K	Fade Background	Open the Fade Background dialog to adjust the background visibility.
	Background Off	
	Fade Background to 10%	
	Fade Background to 20%	

	Fade Background to 30%
	Fade Background to 40%
	Fade Background to 50%
	Fade Background to 60%
	Fade Background to 70%
	Fade Background to 80%
	Fade Background to 90%
	Background On
⌘K Move and Rotate Background	Move the garment, quilt block or fabric that you have placed behind your embroideries around the hoop or project area.
Remove Background	Remove a background that you have placed behind your embroideries.
Zoom	
⌘+	Zoom In Increase magnification.
⌘-	Zoom Out Decrease magnification.
⌘*	Zoom To Rectangle Drag a rectangle around the area you want to zoom in to.
⌘0	Zoom To Fit Fit the work area to the screen.
⌘1	Zoom 100%
⌘2	Zoom 200%
⌘3	Zoom 400%
⌘4	Zoom 800%
⌘5	Zoom 75%
⌘6	Zoom 50%
⌘7	Zoom 25%
View Mode	
	Realistic View Mode View embroideries and background in 3D without selection boxes, grid or hoop.
	3D View Mode View embroideries, background and grid in standard 3D mode.
	2D View Mode View the individual stitches in your embroideries as lines with no shading.
⇧⌘Y Life View	Show how an embroidery exported from the project will look in 3D with real-world perspective.

⌘Y	Design Player	Play through the stitches in the embroidery as if they were being stitched from an exported embroidery.
⌘L	Get Length	Measure the distance between any two points on an embroidery.
⌘\	Display All	Display all stitches in the active embroidery.
⌘/	Show Control Panel	Show the Control Panel.
	Show FilmStrip	Show the FilmStrip.
⌘T	Hide Toolbar	
	Customize Toolbar	Change the buttons on the toolbar.
⌘F	Enter Full Screen	

Design Menu

⌘G	Group	Group the selected designs together so they may be moved, resized or scaled and rotated together.
⇧⌘G	Ungroup	Split a selected group into the designs which make it up.
⇧⌘G	Reveal Groups	Select and edit individual designs within a group.
⇧⌘U	Combine All	Merge all the embroideries in the current window into a single embroidery.
⌘U	Combine Selected	Merge the selected embroideries into a single embroidery.
⇧⌘U	Fix as Stitches	Fix the selected subdesign or subdesigns as an embroidery.
	Rotate 45	Rotate the selected embroidery in 45 degree steps.
	ColorSort	Reduce the selected embroidery to the minimum number of color blocks.
	Color Tone	Convert all the threads in an embroidery to those of another manufacturer. Also adjust brightness and contrast, selecting new threads automatically.
	Modify Design	Open a dialog where you can resize and rotate the selected embroidery or block.
	Endless	Add markers to an embroidery so it can be stitched out in a continuous, regularly spaced, sequence as many times as desired.
	Split Project	Split the embroidery project for any single-part hoop.
	Properties	Change the properties of the selected embroidery or design.
	Edit Design	Edit the selected design in a different module. For example use mySewnet™ Digitizing for an .edo file, or mySewnet™ Stitch Editor for an embroidery.
	Center In Hoop	Move the selected embroidery to the center of the hoop.
	Move Into Hoop	Move the selected embroideries into the nearest area of the hoop.
	Horizontal Alignment	<p>Align Left Align the selected embroideries with the left edge of the design furthest to the left.</p> <p>Align Center Center the selected embroideries horizontally relative to each other.</p> <p>Align Right Align the selected embroideries with the right edge of the design furthest to the right.</p> <p>Distribute Horizontally Align the selected embroideries to be equally spaced horizontally.</p>

Vertical Alignment	
	Align Top Align the selected embroideries with the top edge of the highest design.
	Align Middle Center the selected embroideries vertically relative to each other.
	Align Bottom Align the selected embroideries with the bottom edge of the lowest design.
	Distribute Vertically Align the selected embroideries to be equally spaced vertically.
Layout Order	
⌘F	Move Forwards Bring the selected embroidery one step closer to the front.
⌘B	Move Backwards Bring the selected embroidery one step closer to the back.
⇧⌘F	Move to Front Place the selected embroidery at the front.
⇧⌘B	Move to Back Place the selected embroidery at the back.

Assistants Menu

ExpressMonogram Assistant	Start the ExpressMonogram Assistant to add a one, two or three letter monogram.
ExpressDesign	ExpressDesign into Hoop Create an embroidery automatically to fit the currently selected hoop.
	ExpressDesign into Rectangle Create an embroidery automatically that is a best fit to a rectangular selected area.
PhotoStitch	PhotoStitch into Hoop Create an embroidery automatically from a photo, to fit the currently selected hoop.
	PhotoStitch into Rectangle Create an embroidery automatically from a photo, that is a best fit to a rectangular selected area.
Word Sculpt Assistant	Use the Word Sculpt Assistant to create a word design automatically using your choice of outline, words, and fonts.
Quilt Block Assistant	Create a filled or outline quilt block automatically, or create a quilting fill around an embroidery.
Family Tree Assistant	Create an embroidery chart of your family's history
Project-in-the-Hoop Assistant	Create an in-the-hoop design using your choice of project type, style and dimensions.
Spiro Assistant	Create intricate spiral designs in multiple colors, using Running, Double or Triple stitch lines.

Window Menu

⌘M	Minimize
⇧⌘M	Minimize All
	Zoom
	Bring All to Front

Help Menu

(⌘?)	Search
mySewnet Embroidery Help	List help topics.
	Keyboard Shortcuts

Context Menu

⌘Z	Undo	Reverse the last action.
⇧⌘Z	Redo	Reverse the last action that was undone by Undo.
⌘X	Cut	Delete the selected embroidery or block of stitches from the screen and place it on the clipboard.
⌘C	Copy	Make a copy of the selected embroidery or block of stitches and place it on the clipboard.
⌘V	Paste	Paste an embroidery or block that has been cut or copied to the clipboard onto the screen.
⌘⇧V	Paste into Center	Paste an embroidery or block that has been cut or copied to the clipboard into the center of the screen.
⌘D	Duplicate Selected	Make a copy of the whole embroidery or block which is automatically pasted on the work area.
⌘Delete	Delete	Remove the selected embroidery or block of stitches from the screen without moving it to the clipboard.
Zoom		
⌘1		Zoom 100%
⌘2		Zoom 200%
⌘3		Zoom 400%
⌘4		Zoom 800%
⌘5		Zoom 75%
⌘6		Zoom 50%
⌘7		Zoom 25%
Background Visibility		
		Background Off
		Fade Background
		Open the Fade Background dialog to adjust the background visibility.
		Background On
⌘⇧1	Send	Send the selected embroidery to the mySewnet™ Cloud, or to the connected machine or computer.

Actions Menu

















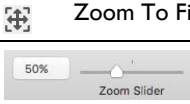





⌘I	Insert	Load a saved embroidery into an existing window.
⌘Z	Undo	Reverse the last action.
⇧⌘Z	Redo	Reverse the last action that was undone by Undo.
⌘X	Cut	Delete the selected embroidery or block of stitches from the screen and place it on the clipboard.
⌘C	Copy	Make a copy of the selected embroidery or block of stitches and place it on the clipboard.
⌘V	Paste	Paste an embroidery or block that has been cut or copied to the clipboard onto the screen.
⇧⌘V	Paste into Center	Paste an embroidery or block that has been cut or copied to the clipboard into the center of the screen.
⌘D	Duplicate Selected	Make a copy of the whole embroidery or block which is automatically pasted on the work area.
⌘⌫	Delete	Remove the selected embroidery or block of stitches from the screen without moving it to the clipboard.
Zoom		
⌘1		Zoom 100%
⌘2		Zoom 200%
⌘3		Zoom 400%
⌘4		Zoom 800%
⌘5		Zoom 75%
⌘6		Zoom 50%
⌘7		Zoom 25%
Background Visibility		
Background Off		
Fade Background		
Open the Fade Background dialog to adjust the background visibility.		
Background On		
⌘S	Save	Save the contents of the window as a multipart embroidery in .vp4 format.
⇧⌘S	Export	Save the embroidery in the current window as a flattened .vp4 file, or in an alternative embroidery format.
⌘P	Print	Print all the embroideries on the screen with their names.







mySewnet™ Menu

Connected	Connected to your mySewnet™ enabled embroidery machine.
mySewnet Options	View the mySewnet™ options in mySewnet™ Configure.
Manage my Account	Log in to your mySewnet™ account.
Send	Send the selected embroidery to the mySewnet™ Cloud, or to the connected machine or computer.

Toolbar

Main Toolbar

	Actions Menu	Use the Actions menu to get quick access to many functions.
	mySewnet™ Menu	Manage your mySewnet™ account and your mySewnet™ enabled embroidery machine via the mySewnet™ cloud.
	Zoom Out	Decrease magnification.
	Zoom In	Increase magnification.
	Zoom To Rectangle	Drag a rectangle around the area you want to zoom in to.
	Zoom To Fit	Fit the work area to the screen.
	Zoom Percentage and Slider	Use the slider to change the percentage magnification.
	Box Select	Drag to select embroideries in a rectangular area.
	Freehand Select	Draw a line to select embroideries within an area of any shape.
	Point Select	Select embroideries within an area of any shape made of straight and curved lines, defined by a series of points.
	Select Stitches	Select and edit single stitches.
	Select All Visible	Select all visible stitches in the current embroidery.
	Deselect All	Deselect every selected stitch and block, including any that are outside the chosen hoop.
	Replace Selection	Replace the currently selected embroideries or stitches with the new selection.
	Add To Selection	Add the new selection to the currently selected embroideries or stitches.
	Remove From Selection	Remove the new selection from the currently selected embroideries or stitches.
	Group	Group the selected designs together so they may be moved, resized or scaled and rotated together.
	Ungroup	Split a selected group into the designs which make it up.
	Resize	Switch between resize and scale.
	Hoop	Select the desired hoop size.
	Load Background	Start the Background Assistant to preview embroideries on a garment, quilt block or fabric.
	Background Visibility	Open the Fade Background dialog to adjust the background visibility.
	Move and Rotate Background	Move the garment, quilt block or fabric that you have placed behind your embroideries.

	Realistic View Mode	See embroideries and grid in standard 3D mode.
	3D View Mode	See the individual stitches in your embroideries as lines with no shading, and with stitch points.
	2D View Mode	See the individual stitches in your embroideries as lines with no shading or stitch points.
	Life View	Show how an embroidery exported from the project will look in 3D with real-world perspective.
	Design Player	Play through the stitches in the embroidery as if they were being stitched from an exported embroidery.
	FilmStrip	View or hide the FilmStrip.
	Control Panel	View or hide the Control Panel.

Control Panel

Design Window

Use the Design window  to view the colors and design information for your embroidery.

Color Select

A worksheet panel showing the color blocks in the embroidery. It is used to change the thread color, show which color blocks are visible and turn the display of color blocks on and off.

Design Information







Stitch Count : The Stitch Count of the embroidery.

Width : The Width of the embroidery.

Height : The Height of the embroidery.

Colors : The number of colors in the embroidery.

Modify

	Rotate 45	Rotate the selected embroidery by 45 degrees.
	Center In Hoop	Center the embroidery in the hoop.
	Modify Design	Open a dialog where you can resize and rotate the selected embroidery.
	Color Tone	Convert all the threads in an embroidery to those of another manufacturer. Also adjust brightness and contrast.
	Edit Design	Edit the selected design using the appropriate tool or module.
	Endless	Add markers to an embroidery so it can be stitched out in a continuous, regularly spaced, sequence.
	Split Project	Split a large embroidery project into sections for stitching out.

Notes

Enter up to 2000 characters in the Notes  for information and keywords about the embroidery.

Settings

Enter up to 2000 characters in the Settings  for information on the techniques used for the embroidery.

Edit

Edit  the Notes or Settings.

Help

Show help  for the Design window.



Create Window

Use the Create window  to use the ExpressDesign Assistant , the ExpressMonogram Assistant , the Word Sculpt Assistant , the Quilt Block Assistant , the Spiro Assistant , the PhotoStitch Assistant , the Family Tree Assistant  or the Project-in-the-Hoop Assistant  to create a design. You can also insert a digitized design with mySewnet™ Digitizing , or open a cross stitch design with mySewnet™ Cross Stitcher .

Encore Window

Use the Encore window  to place repeated copies of embroideries in a circle, a line, a shape, or around the edge of the hoop. See “Encore” on page 103.

Letter Window

Use the Letter window  to create lettering to personalize your embroidery project using single or multicolor fonts (lettering styles) and fonts of special characters. Use Name Changer  to create a series of embroideries. See “Creating Lettering” on page 355.

SuperDesign Window

Use the SuperDesign window  to create SuperDesigns, special designs that can be resized with constant stitch density, from the SuperDesign sets available in mySewnet™ Embroidery. See “Creating SuperDesigns” on page 438.

Frame Window

Use the Frame window  to select corners, flourishes, frames, side pieces, borders and motif underlines to place around your embroidery. See “Creating Frames, Borders and Underlines” on page 445.

Appliqué Window

Use the Appliqué window  to create and adjust appliqué pieces. See “Appliqué” on page 184.

Embellish Window

Use the Embellish window  to decorate your chosen background and embroidery with ribbon, strings of beads, yarn, and individual beads, sequins, hotfix crystals or nailheads. See “Embellishments” on page 156.

Modify Window

Use the Modify window  to select and edit stitches and blocks of stitches, and add commands, stitches and ties. See “Modifying Stitches and Blocks” on page 125.

Design Information

Stitch Count : The Stitch Count of the embroidery.

Width : The Width of the embroidery.

Height : The Height of the embroidery.



Colors : The number of colors in the embroidery.

Color Select







A worksheet panel showing the color blocks in the embroidery. It is used to change the thread color, show which color blocks are visible, to change the order of color blocks in the design, and to merge color blocks.

Draw Range

The upper slider sets the Draw From Start stitch. The lower slider sets the Draw To End stitch. Move the appropriate slider to change the start or end stitch. Stitches are not displayed when the color block containing the stitches is hidden.

	Modify Block	Open a dialog where you can resize and rotate the selected block.
	Get Length	Measure the distance between any two points on an embroidery.
	Display All	Display all stitches in the currently active embroidery.

Stitch

	Insert Color Change	Add a new color change at the point where you click.
	Insert Stop	Add a command which instructs the embroidery machine to stop at the point where you click.
	Insert Trim	Add a command which instructs some embroidery machines to cut the thread.
	Delete Commands	Delete an unwanted Color Change, Stop or Trim command.
	Insert Stitches	Add new stitches to an embroidery.
	Insert Tie-On Stitch	Add a tie stitch at the beginning of the stitch area to be secured.
	Insert Tie-Off Stitch	Add a tie stitch at the end of the stitch area to be secured.





Help

Show help for the Modify window.

FilmStrip

View your design in the FilmStrip.

Stitch Order

 Stitch Later	Bring the selected embroidery(ies) or group one step closer to the front.
 Stitch Earlier	Bring the selected embroidery(ies) or group one step closer to the back.
 Stitch Last	Place the selected embroidery(ies) or group at the front.
 Stitch First	Place the selected embroidery(ies) or group at the back.
 Reveal Groups	Select and edit individual designs within a group.

Keyboard Shortcuts

You can use your keyboard, mouse, and trackpad to quickly perform many tasks in mySewnet™ Embroidery. To find shortcuts for common menu commands, look in the menus (or see the shortcuts listed here). To perform an action, press the keys in the order shown here.

Action	Shortcut
Working with designs	
Select the next embroidery in the work area	Command–right arrow (⌘ →)
Select the previous embroidery in the work area	Command–left arrow (⌘ ←)
Add objects to (or remove them from) the current selection	Command–click to add or remove objects from the current selection
Resize or scale an embroidery	Drag corner handle
Resize proportionally	Hold Shift and drag a corner handle
Resize from center	Hold Option and drag a corner handle
Nudge the selected design to the left	Left arrow (←)
Nudge the selected design to the right	Right arrow (→)
Nudge the selected design up	Up arrow (↑)
Nudge the selected design down	Down arrow (↓)
Rotate an embroidery	Drag round handle
Mirror vertically	Click the triangular top handle
Mirror horizontally	Click the triangular side handle
Open a Shortcut Menu	Control–click

- For more shortcuts, see “Tools and Techniques” on page 7 and “Quick Reference Guide” on page 540.

Character Sets

The character set contains the following characters:

ABCDEFGHIJKLMNOPQRSTUVWXYZ
abcdefghijklmnopqrstuvwxyz
0123456789 spc
!"#\$%&'()*+,-./:;,.
ÁÂÃÄÅÆÇÈÉÊËÌÍÎÏÐÑÒÓÔÕÖØÙÚÛÜÝÞß
àáâãääæçèéêëìíîïðñóôõöøùúûüýþÿ

Using Fonts

When selecting fonts you can choose the font, line format, size, stitch type and thread color. Place lettering around your embroidery, or anywhere on the work area. Lettering can be resized with constant stitch density, and the stitch properties adjusted, until it is fixed as embroidery.

Font Name

Font names include information in addition to the name of the lettering style. All font names include the recommended size range, and other information is often included. Some fonts are uppercase only, and some are lowercase only.

Font Type

2C	The font uses two colors (also 3C for colors, etc.)
LC	Lowercase only font
NP	Nearest Point font
UC	Uppercase only font

Use Special Characters to add the extra characters used in many languages, for example ß, that are not present on your keyboard. See “Emoji and Symbols” on page 365.

Alternative Alphabets

You can enter characters in other alphabets from the National font category, such as Greek and Hebrew. Use the key listed in the table to obtain the desired character.

Hebrew

On your keyboard, use the character below the Hebrew character to write that character. Numbers, symbols and punctuation use their usual keys.



! A B C D E F



G H I J K L M



N O P Q R S T



U V W X Y Z

Greek

On your keyboard, use the character below the Greek character to write that character. Numbers, symbols and punctuation use their usual keys.

Α Β Γ Δ Ε Θ Η

A B C D E F H

Ι Χ Κ Λ Μ Ν Ο

I J K L M N O

Π Ω Ρ Σ Τ Υ ΄

P Q R S T U V

Ψ Ξ Φ Ζ α β γ

W X Y Z a b c

δ ε θ η ι χ κ

d e f h i j k

λ μ ν ο π ω ρ

l m n o p q r

σ τ υ ς ψ ξ φ

s t u v w x y

ζ

z

Index

- Numerics**
- 2D Template..... 150
- 2D View 50
- 3D
 - Realistic 49
 - Standard 49
- 3D Background
 - Color 115
 - Texture 115
- 45 Degree Rotate 98
- A**
- Abbreviation 79
- About 5
- About Fonts 430
- Add 3 points to curve 372
- Add a point to curve 372
- Add Stitches 138
- Add To Selection 91
- Adding Decorations 169
- Adding Ribbon 160
- Adjust a MultiWave Fill 480
- Adjust Embroidery
 - Quilt Block Assistant..... 245
- Adjust your Imported Font 389
- Aids for Alignment..... 151
- Align
 - Bottom 102
 - Center 101
 - Left 101
 - Middle 102
 - Right 101
 - Split Project Sections 150
 - To Previous Sections 152
 - Top 101
 - With Corner or Baste Alignment Stitches
152
 - With No Alignment Stitches 152
- Alignment
 - General Considerations 150
 - Horizontal 101
 - Lettering 366, 398
 - Other Aids 151
 - Stitch 152
 - Stitch Style..... 145, 154
 - Tools 101
 - Vertical 101
 - With No Stitches 145, 152
- All
 - Combine 29
 - Select 89
- Already Endless 115
- Alternative Style
 - Small Letters 343
- Ancestors Chart 321
- Angle 245
 - Background Picture 64
 - Fill in Quilt Block 245
 - Linear PhotoStitch Embroidery 312
 - Motif Fill 470
 - Pattern Fill 419, 464
 - Tiles 310
- Animals I — Patterns 37 to 48 511
- Animated Demo 72
- AnimationPath.txt 72
- Appliqué 184–202, 416
 - Method 202, 232, 416
 - Monogram 347
 - Options 202
 - Placement 202
 - Stitching Out ExpressDesign 233
 - Stitching Out Frame 447
 - Stitching Out Letter 417
- Appliqué Embroidery
 - Change Fabric 185
- Appliqué Frame
 - Stitching Out..... 447
- Appliqué Hole..... 187
- Appliqué Options
 - Express Border 232
- Appliqué Outline..... 186
- Appliqué Piece 185
 - Export 39
 - Margin 203, 233, 417
- Appliqué Piece Margin..... 197, 203, 233, 417
- Appliqué Selection 195
- Appliqué Window 555
- Arch 372
- Arch Over 376
- Arch Under 376
- Area
 - Define with Eraser 296
 - Get Length..... 127
 - Group..... 91
 - Work 12
- Area Sensitivity
 - Express Border 231
 - Express Trace 228
 - Picture Options 221
- Arrange Similar
 - Encore 111
- Arrangement Options
 - Encore 111
- Arrows — Patterns 49 to 60 511
- Artistic Effect
 - Linear PhotoStitch 311
- Assistant
 - Background..... 56–68
 - Choose and Optimize Photos 279

Choose and Optimize Pictures for	
ExpressDesign.....	206
Endless	112
ExpressDesign	204–238
Family Tree.....	314–332
Monogram	333–354
PhotoStitch.....	277–313
Project-in-the-Hoop.....	261
QuickFont	401–429
Quilt Block	239–255
Spiro.....	271
Split Project.....	141–152
Word Sculpt	264–??
Autolevel	281
PhotoStitch Assistant	199, 299
Remove Background	280
Automatic	
Ghost Mode	127
Kerning.....	362, 397
B	
Background	
Assistant.....	56–68
Color.....	115
Delete	56
Fade.....	53
Grid.....	12
Load	53
Move	54
Name	67
Remove	295
Reset Removal.....	297
Size.....	66
Texture	115
Undo Removal.....	297
Visibility	56
Background Assistant	
Create Garment	68
Background Color	
ExpressDesign	219
Remove in ExpressDesign Assistant	219
Remove Multiple.....	220
Background Off.....	54
Background On.....	54
Backgrounds	21
Real Size	56
Backup	
My Fonts.....	533
Backwards	
Move	102
Bar	
Menu	11
Zoom	115
Bars	
Richelieu	497
Baseline	
QuickFont	422, 428
Baste	
Alignment Stitches	145, 152
Bead	156
Beads	
String of.....	166
Black Lines	221
Block	370
Deselect	129
Horizontally Flip.....	100
Modify	132, 554
Paste.....	129
Select.....	128
Vertically Flip	100
Block Selection and Draw Range.....	134
Block Templates	374
Blue	
Handles for Resize.....	96, 129
Border	
Express.....	204
Express Options	230
Individual Letter.....	346, 351
Monogram	346
Monogram Adjust.....	351
Options	457
Type	230
Both	
Endless Marker	113
Bottom	
Align	102
Bowl.....	376
Box	
Select.....	90, 129
Selection.....	87
Break Up Line.....	173
Bridge Concave Down	378
Bridge Concave Up.....	378
Bridge Convex Down	378
Bridge Convex Up	378
Brightness	
Color Tone.....	84
Butte	379
Butterflies	
Motif Underline.....	460
Butterfly Motif Underline	460
C	
Camera.....	199, 213, 292
Category	
Font.....	360
Font Name	425
Motif Selection.....	509
Center	
Align	101
In Hoop	100
Lines	151
Center Motifs 1 and 2.....	471
Center of	
Rotation	98
Central Point	505, 507
Champion Dad.....	455
Change	

All To	217, 303	Close	6
Colors	399	Save On	31
Colors Frames	453	Close a Document	5
Existing Thread Color	79	Color	
Hoop	144	3D Background	115
Letter Properties	398	Change Existing Thread	79, 350
Name	433	ExpressDesign Background	219
SuperDesign Properties	442	Information	518
Thread	218, 304	Linear PhotoStitch Embroidery	311
Change a Crosshatch Fill	474	List	218
Change a Motif Fill	471	Match	344
Change a Pattern Fill	465	Order	218
Change a Shape Fill	485	Preview Thread	220, 223, 305
Character Set	559	Select	78, 554, 556
Cyrillic 1	407	Selection	217, 303
Cyrillic 2	407	Thread	228, 231
Cyrillic 3	408	Tone	84
Extended	406	Color Block Selection and Draw Range	134
Greek	561	Color Blocks	
Greek I	409	Move and Merge	133
Hebrew	560	Color Change	
Hebrew I	409	Insert	135
Hiragana 1	408	Color PhotoStitch	
Hiragana 2	408	Creating	287
Latin 1	406	Embroidery	277, 289
QuickFont	405	Color Select	78
Super-Extended	406	Color Tile Embroidery	278, 290
Western 1	406	Photos	282
Western 2	407	Color Tile Options	308
Western 3	407	Color Worksheet	78
Western 4	407	Colors	554, 556
Characters		Change	399
Enter Special	365, 559	Change Frames	453
Not Available in Font	364	Choose Thread	217, 303
Chart		Edit	77
Ancestors	321	Frames	453
Check Spelling	364	Lettering	399
Chevron	379	Number of	217, 303
Children	317, 319	Reduce	303
Choose		Remove Multiple Background	220
Background	57	SuperDesigns	443
Connection Method	324, 381	Thread	78
Fabric	151	View Selected	133
Photos for PhotoStitch Assistant	279	Colors Window	83
Picture	198, 212, 291	ColorSort	86, 397
Pictures for ExpressDesign Assistant	206	Endless	114
Thread Colors	217, 303	Frame	453
Choose Design Type	210	Lettering	399
Circle		SuperDesign	443
Encore	105, 444	Combine	29
Circle Clockwise	367	All	29
Circle Counter-Clockwise	367	Remove Overlap	515
Circles 1 — Patterns 61 to 72	511	Selected	30
Circles 2 — Patterns 73 to 84	511	Commands	135
Circular		Delete	138
Rotate Handle	87	Compensation	
Cleaning a Picture	207	Fill	420
Climate — Patterns 85 to 96	512	Pattern Fill	464
Clipboard	243	Satin Area	493

Satin Column	414, 495
Split Project	145, 154
Complex Shapes	432
Complexity	430
Connected Outlines	209
Connection	
Lettering	363, 398
Method	381
Split Project	146, 154
Types	363
Connection Method	324
Connector Type	328
Constant	
Density	96
Stitch Count	96
Constraint - Free	374
Constraint - Italic	374
Constraint - Pennant	373
Constraint - Perspective	373
Constraint - Size	373
Constraints	373
Continuous Fonts	
QuickFont	423
Continuous Satin	494
Contour Fill	492
Contrast	
Color Tone	84
Control Panel	10, 554
Convert	
Frame to Embroidery	453
Lettering to Embroidery	400
SuperDesign to Embroidery	443
Thread Range	85
Copies	
Print Number	519
Copy	122
Corner	
Alignment Stitch	145, 152
Endless Marker	113
Corners	445, 555
Rounded Border	346
Crayon	79
Create	
Lettering	355, 356
SuperDesigns	438
Create a Border	457
Create a Family Tree Embroidery	330
Create a Flourish	447
Create a Font from Embroidered Letters	387
Create a Frame	446
Create a Multicolor Gradient Fill	469
Create a Single Motif	459
Create New Chart	317
Create Window	555
Creating	
Embroideries	534
Creating Fonts	401
Creating Frames	445
Creating Motif Underlines	459
Crop	
Picture for Fabric	64
Crop Picture	
Load Picture Assistant	200
Crosshatch	
Curved	476
Crosshatch Fill	473
Cursive	430
Curve	372
Curved	
QuiltStipple Fill	490
Curved Crosshatch Fill	476
Properties	476
Customize	
Toolbar	9
Cut	122
Cut Line	
Quilt Block	242
Cut-out	202, 232, 417
Cutwork Needle	82
Cutwork Needle Lines	38
Cyrillic 1 Character Set	407
Cyrillic 2 Character Set	407
Cyrillic 3 Character Set	408
D	
Dark Borders and Backgrounds	209
Decide Stitch Out Order	150
Decorated Bells	178
Decoration	156
Decoration Gallery Design	171
Decoration Line	
Point	159
Decoration Selection	174
Decoration Template	
Export	41
Decorations	156-183
Editing	172
Export	176
Delete	123
Commands	138
Font	383
Thread Color	218, 304
Delete All	
Thread Color	219, 304
Delete Background	56
Delete Piece	191
Delete Points	173, 191
Delete Selection	173
Demo	72
Density	
Constant	96
Gradient	466, 488
Linear PhotoStitch Embroidery	312
Normal	464, 487
Pattern Fill	419
Radial Fill	486
Richelieu Bars	498
Satin Area	493

Satin Border	421
Satin Columns	414, 495
Satin Line	504
Shape Fill	484
Standard	464
Stitch Options	306
Depth	
Scan	312
Descendants Chart	317, 319
Description	
Thread	391
Deselect	
Block	129
Deselect All	90, 132
Design	
Information	13, 71, 223, 554, 556
Preview	306
Scale	518
Window	554
Design Player	73
Video Speed	76
Design Size	
PhotoStitch Assistant	302
Design Underlay	
ExpressDesign	222
Design Viewer	11
Design Window	
Open	77, 184
Designing with Ribbon	161, 163, 166
Designs	
Grouping	91
Detail	
Enhance	281, 306, 312
Diagonal Corners	
Echo Fill	482
Diamond	372, 375
Crosshatch Fill	473
Curved Crosshatch	476
Tile Shape	308
Diamonds — Patterns 97 to 108	512
Different Colors for Frames	453
Different Colors for Lettering	399
Different Colors for SuperDesigns	443
Digital Camera	199, 213, 292
Dimensions	
Printing	518
Display	
All	134
Display Names As	318
Distribute	
Horizontally	101
Vertically	102
Done	
Family Tree Assistant	325, 327, 329
Double Arch	375
Double Diamond	372
Double Stitch	
Length	203
Properties	501
Double Trace	227
Double with Zigzag Return	502
Double Zigzag	502
Draw Embellishment Shape	159
Draw From Start	135
Draw Line	170
Draw Range	135
Draw Range (Sliders)	135
Draw Range and Color Blocks	134
Draw To End	135
Dual Thread	80, 81
Duplicate	31, 33
Font	382
E	
Echo Fill	482
Properties	482
Echo Lines	482
Edge Walk Underlay	
Satin Border	421
Satin Columns	414
Edit	
Colors	77
Embroideries	24
Frames and Borders	445
Single Stitches	138
Stitches	138
SuperDesigns	441
Edit Design	27
Edit Frames	451
Edit Individuals	317
Editable Properties	462
Editing Decorations	172
Effect	
Artistic	311
Effects	80
Embellish Window	555
Open	156
Embellishments	156
Embroideries	
Edit	24
Grouping	91
Managing	24
Open	26
Open Recently Used	26
Remove Overlap When Combining	515
Save	30
View	49
Embroidery	
Color PhotoStitch	277
Create	534
Endless	112
Express	204
Fix Frame	453
Fix Lettering	400
Fix SuperDesigns	443
Linear PhotoStitch	278
Modify	87
On Heavy Knit Fabric	464, 468, 487, 504

On Linen	464, 468, 487, 504	Export Appliqué Pieces	39
On Satin	464, 468, 487, 504	Export Decoration Template	41
On Thick Fabric	464, 468, 487, 504	Exporting Decorations	176
Open	243	Express Appliqué	188
Repeat	103, 114, 555	Express Border	204
Select	87	Options	230
Sepia PhotoStitch	277	Pictures	209
Specks	299	Express Embroidery	204
Split	143	Express Trace	204
Stitch Out Endless	117	Double	227
Test Stitch Out of Endless	118	Method	227
Encore	103	Options	227
Circle	444	Pictures	208
Shape	108	Quadruple	227
SuperDesigns	444	Satin Line	227
Window	555	ExpressDesign	
End		Assistant	204–238
Draw To	135	Choose and Optimize Pictures	206
End Marker	113	Choose Design Type	210
End Point	505, 507	Pictures	208
Endless		Select Method	210
Already	115	Extended	
Embroidery	112	Character Set	406
Embroidery Stitch Out	117	Eye	
Embroidery Test Stitch Out	118	Red	300
Hoop Orientation and Fabric Direction		Select	300
Examples	116	F	
Enhance Detail	281, 306, 312	Fabric	
Enhancing Details	208	Embroidery on Heavy Knit	464, 468, 487, 504
Enter		Embroidery on Thick	464, 468, 487, 504
Letters	364	ExpressDesign	222
Special Characters	365, 559	Rotate and Crop Picture	64
Enter Angles		Select	191
Crosshatch Fill	473	Fabric Advisor	
Curved Crosshatch	476	ExpressDesign	222
Enter Another Partner	319	Fabric and Stitch Type Options	222
Enter Size		Fabric Choice	
Hoop	23	Split Project	151
Quilt Block	241, 258	Fabric Direction	
Envelopes		Endless Embroidery	112
Monogram	338	Examples	116
Erase		Fade	
Flood	297	Background	53
Eraser		Family	317
Background Removal	296, 298	Family Name	319
Large	296	Family Tree	
Medium	296	Assistant	314–332
Small	296	Fan	376
Error Messages	521	Father	321
Examples of Endless Hoop Orientation and		Feather	
Fabric Direction	116	Both Sides	496
Existing Thread Color	79	One Side	497
Exit		Feathered Satin	496
Save On	31	Felting Needle	82
Expand		Female	319
Find Outline	224	File	
Pixel-Thin Lines	221	Formats	20
Export	31, 33		
Monogram	352		

Fill		Font	
Angle	419	Category.....	360
Contour	492	Complexity.....	431
Curved Crosshatch.....	476	Create	401
Echo	482	Create New.....	427
ExpressDesign	222	Delete	383
Flood	295	Duplicate	382
MultiWave	479	Gap	381
Pattern	249	Guidelines.....	430
Satin Effect.....	465, 511	Height and Width	381
Tiles.....	309	Import External	385
Fill + Satin Border	415	LC Lowercase.....	364
Fill Density		Letter Properties	397
Tiles.....	309	Name	361, 425, 559
Fill Pattern		New	426
Select.....	249	Properties.....	462
Fill Patterns.....	511	QuickFont	404
Fill Properties		Search.....	357, 359
Pattern	465	Select.....	323
FilmStrip	9, 557	Selection.....	359
Find		Special Characters Not Available	364
Outline	224	Style	340, 343
Thread.....	79	UC Uppercase	364
First Individual.....	317, 319	Variations	430
First Name.....	319	Font Manager.....	382
First Section		Font Viewer.....	358
Split Embroidery	147	Fonts	
Stitch Out.....	151	OpenType® Symbol.....	362
Fit Motif To Line		Special	362
Curved Crosshatch Fill	478	TrueType® Symbol.....	362
Motif Line	507	Force Even Distribution	374
MultiWave Fill.....	480	Formats	
Shape Fill	485	File.....	20
Tapered Motif.....	500	Formatting Multi-Lines	366, 398
Fit To Hoop.....	205	Forwards	
Fit To Rectangle.....	206	Move	102
Fit To Straight Line	369	Frame	326, 445, 555
Resize	369	Change Size	452
Fit To Wavy Line	369	Create	446
Resize.....	369	Fix as Embroidery	453
Fix		Options	452
Frame as Embroidery	453	Frames	
Lettering as Embroidery.....	400	Different Colors	453
SuperDesigns as Embroidery.....	443	Free	
Fix as Stitches	30	Constraint	374
Flag.....	375	Free Rotation.....	98
Flip		Free Sculpt.....	376
Block Horizontally	100	Freeform	375
Block Vertically	100	Freehand Appliqué Hole.....	187
Handles	87	Freehand Appliqué Outline	186
Vertical and Horizontal	100	Freehand Select	90, 131
Flood Erase.....	295, 297	Full	
Flourish.....	445, 447, 555	Letter	340
Create	447	Letter Options.....	349
Flourish Surround Options.....	450	Full Circle	368
Foam		I Love the Sunshine Lettering	391
Puffy	80	G	
Foam Frame		Gallery	
Stitching Out	448		

insert from.....	160	Blue	87, 96, 129
Gallery Design		Green	87, 178, 180, 181
String of Beads	168	Lettering.....	357, 366
Gamma		Light Green.....	89
Picture	84	Menu Lettering	370
Gap		Orange	88, 92
Encore	108, 110	Red	62
Endless	114	Resize and Scale.....	96, 129
Font.....	381	Rotate	87
Minimum.....	478, 479, 484, 500, 506	Round.....	13
Motif Fill	471	Square	13
Gap and Automatic Kerning		Square Resize.....	87
Letter Options.....	362	Triangular Flip.....	87
Letter Properties	397	White	87, 96, 129
Gaps in Pictures	208	Handles Menu.....	370
Gem	379	Heading 3	
Gender	319	Select an Embellishment Type	157
General Alignment Considerations.....	150	Hearts — Patterns 109 to 120	512
General Considerations		Heavy Knit Fabric.....	464, 468, 487, 504
ExpressDesign Assistant.....	206	Hebrew	560
Get Length.....	127	Hebrew 1 Character Set.....	409
Getting Started	1, 7	Height.....	554, 556
Ghost Mode		Font.....	381
Automatic.....	127	Height and Width	
Given Above Family Name.....	318	Letter Options.....	362
Given Beside Family Name.....	318	Letter Properties	398
Given Name	319	Motif Selection.....	509
Given Name Only	318	SuperDesign.....	440, 442
Glow in the Dark.....	71	Help.....	4
Gradient		Menu	548
Multicolor.....	468	Hexagon	
Gradient — Patterns 253 to 264.....	512	Tile Shape	308
Gradient Density	466, 488	High	
Spiral Fill	487	Compensation	146
Gradient Fill.....	466	Highlight Thread	391
Grandchildren.....	317, 318, 320	Hiragana 1 Character Set.....	408
Grandparents.....	321	Hiragana 2 Character Set.....	408
Grapes and Birds in a Frame	454	Hole	
Great Grandchildren.....	318, 320	Appliqué	187
Great-Grandparents	322	Hoop	
Greek	561	Center In	100
Greek 1 Character Set.....	409	Change	144
Green Handles.....	178, 180, 181	Encore	109
Grid.....	12, 50	Fit To.....	205
Print	518	Group.....	22
Size.....	515	Move Into	100
Group.....	91	Orientation Examples	116
Area	91	Project.....	261
Border.....	459	Selection.....	22
Encore.....	111	Size.....	22, 143
Hoop.....	22	Split Project Assistant	153
Motif Selection.....	509	Splitting.....	36
Grouping Selected Embroideries	91	Templates and Printed Worksheets	151
Groups		Horizontal	
Using	91	Alignment	101
Guidelines.....	431	Flip	100
H		Horizontal Block.....	374
Handles		Horizontal Mirror	
		Quilt Block	246

Horizontally	
Distribute	101
Flip Block	100
How to Create a Font	401
How to Create Lettering	323
I	
Identical	
Small Letters	343
Import External Font	383, 385
Import Font from Embroideries	538
Inches	127
Include a Linking Stitch	503
Include Additional First and Last Bar	498
Included in My Hoops	22
Individual	
Place Bead	169
Individual Letter Border	351
Border Options	346
Information	
Color	518
Design	13, 71, 223, 268
Endless Embroidery	115
Print	518
Save Embroidery Project	147
Technical	518
Insert	
Color Change	135
Stitches	138
Stop	136
Tie Stitch	139
Trim	137
Insert from Gallery	160
Insert Points	190
Decoration	173
Intelligent Split	144, 154
Italic	375
Constraint	374
J	
Joining Point	
QuickFont	422
K	
Keep and Remove Parts of Photo	280
Keep Original Picture	206, 279
Kern	
Curved Crosshatch Fill	478
Motif Line	507
MultiWave Fill	480
Shape Fill	485
Kerning	
Letter Options	362
Letter Properties	397
Keyboard	
Shortcuts	558
Keyboard Shortcuts and Shortcut Menus ..	15
L	
Lace — Patterns 253 to 264	512
Large	
Eraser	296
Letter	338
Last	
Split Embroidery Section	147
Latin I Character Set	406
Layout Order	102
LC Lowercase Font	364
Left	
Align	101
Left Taper	505, 507
Left/Bottom	
Endless Marker	113
Leisure I — Patterns 121 to 132	512
Length	
Double Stitch	203
Double Zigzag	503
Get	127
Running Stitch	203
Letter	
Full	340
Individual Border	346, 351
Small	338, 343
Letter Borders	
Spacing	335
Letter Options	365
Letter Properties	396
Change	398
Lettering	
Create	355, 356
Different Colors	399
Fix as Embroidery	400
Handles Menu	370
Resize Fit To Straight Line	369
Resize Fit To Wavy Line	369
Size and Spacing	365
Lettering Window	
Open	355
Letters	
Entering	364
Letter Properties	397
Library	
mySewnet™	46
Life View	70
Line	
Between Letters	351
Break Up	173
Encore	107
Endless Marker	113
Fit Motif To	478, 480, 485, 500, 507
Formatting	366, 398
Lettering Shapes	367
Motif Underline	460
Satin	504
Type	366
Vertical	370
Linear Embroidery Options	311
Linear PhotoStitch	
Angle	312
Creating	286

Embroidery.....	278, 290, 311
Photos.....	283
Thread Color.....	311
Linen.....	464, 468, 487, 504
Lines	
Black.....	221
Center.....	151
Echo.....	482
Expand Pixel-Thin.....	221
Reduce Thick.....	221
Load Background.....	53, 58
Load Embroidery	
Quilt Block Assistant.....	243
Low	
Compensation.....	146
Lowercase Font LC.....	364
M	
Make Block From Visible Area.....	131
Male.....	319
Managing Embroideries.....	24
Margin	
Adjust Embroidery.....	246
Appliqué Piece.....	197
Border.....	336
Border Options.....	346, 458
Encore.....	110
Marker	
End.....	113
Positions.....	113
Match	
Color.....	344
Match Placement Line.....	197, 203, 233, 417
Override.....	516
Maximize.....	5
Maze	
Linear PhotoStitch.....	312
Measurement Units.....	518
Medium	
Eraser.....	296
Menu	
Bar.....	11
Help.....	548
Menus.....	540
Merge	
Color Blocks.....	133
Method	
Choose Connection.....	324, 381
Express Trace.....	227
Outline Stitch.....	418
Richelieu Bars.....	498
Splitting Embroidery.....	144
Method for Appliqué.....	202, 232, 416
Middle	
Align.....	102
Millimeters.....	127
Minimize.....	5
Minimum Gap	
Curved Crosshatch Fill.....	478
Motif Line.....	506
MultiWave Fill.....	479
Shape Fill.....	484
Tapered Motif.....	500
Minimum Significant Stitch Length.....	38
Mirror	
Horizontal Quilt Block.....	246
Motif Selection.....	510
Vertical Quilt Block.....	246
Mirrored	
Encore.....	105
Mitered End.....	504, 507
Modify	
Block.....	132, 554
Design.....	99
Stitch.....	135
Modify Window.....	125
Open.....	125
Modifying Embroideries.....	87, 522
Monochrome	
PhotoStitch Embroidery.....	278, 289
Monochrome Linear	
Linear PhotoStitch.....	311
Monochrome PhotoStitch	
Photos.....	282
Monochrome Threshold.....	226
Monogram	
Appliqué.....	347
Assistant.....	333-354
Border.....	346
Create.....	334
Envelopes.....	338
Select.....	338
Size.....	341
Spacing.....	341
Style.....	338
Mosaic — Patterns 133 to 144.....	512
Mosaic — Patterns 265 to 276.....	512
Mother.....	321
Motif	
Curved Crosshatch Fill.....	477
Fit To Line.....	478, 480, 485, 500, 507
Length.....	460
Tapered Motif.....	499
Motif Fill.....	470
Motif Line.....	506
Motif Selection.....	509
Motif Underline.....	459
Motifs	
Center 1 and 2.....	471
Motif Line.....	506
MultiWave Fill.....	479
Shape Fill.....	484
Move	
Background.....	54
Backwards.....	102
Center of Rotation.....	98
Color Blocks.....	133
Embroidery.....	96

Forwards	102
Into Hoop	100
To Back	103
To Front	103
Move Down	
Color	219
Move To	48
Move Up	
Color	219
Movement Stitch	
Split Project	146
Multicolor Gradient	468
Multi-Line	
Formatting	366, 398
Multipart Hoops	
Splitting	36
Multiple	
Background Colors	220
Multiple Designs	
Encore	106
Multiple Outlines	431
Multiple Select	88
Multi-Touch Gestures	18
MultiWave Fill	479
My Demo	
Backup	531
Play	72
My Fonts	
Backup	533
My Hoops	22
mySewnet™	42
mySewnet™ Configure	115, 127
mySewnet™ Library	46
mySewnet™ Machine	43
mySewnet™ Options	45
N	
Name	
Background	67
Font	361, 425, 559
Name Changer	433
Nearest Point	
QuickFont	422, 428
New	24
New Font	
QuickFont	426
Next	
QuickFont	427
Split Section	147
Next Piece	190
Next Section	154
No Change	
Picture Outline	221
No Taper	505, 507
None	
Alignment Stitch	145, 152
Compensation	145
Normal Density	487
Pattern Fill	464

Notes	28, 554
Printing	518
Nudge	
Embroidery	96
Number of Colors	
ExpressDesign	217
PhotoStitch	303
O	
Octagon	378
Offset	
Motif Fill	471
Open	26
Design Window	77, 184
Embellish Window	156
Embroidery	26, 243
Lettering Window	355
Modify Window	125
Recently Used Embroideries	26
SuperDesign Window	438
OpenType® Fonts	430
OpenType® Symbol Fonts	362
Optimize Photos	
PhotoStitch Assistant	279
Optimize Pictures	
ExpressDesign Assistant	206
Optimize Stitch Length	38
Options	
Appliqué	202, 232
Contour Fill	492
Express Border	230
Express Trace	227
Fabric and Stitch Type	222
Frame	452
Letters	365
Pattern Fill	463
Picture	221, 299
Print	149
Radial Fill	486
Shape Fill	484
Stitch	306
Trace	228
Word Sculpt	266
Orange	
Handles	88, 92
Order	
Layout	102
Orientation	
Hoop	22
Print Setup	519
Original Picture	206, 279
Monochrome Threshold	226
Other Topics	530
Outline	432
Appliqué	186
Connected	209
Find for Quick Trace	224
Finder and Expander	224
QuickFont	418

Output Options	49 to 60 (Arrows).....	511
QuickFont	61 to 72 (Circles 1).....	511
Output Size	73 to 84 (Circles 2).....	511
QuickFont	85 to 96 (Climate)	512
Output Size Range	97 to 108 (Diamonds).....	512
QuickFont	PDF Guides.....	5
Overlap	Pencil	79
Embroidery Project.....	Pennant	
Remove	Constraint	373
Remove on Combine	Pennant Left.....	377
Overlapping Shapes.....	Pennant Right.....	377
Override margin width.....	Pentagon.....	380
Override Match Placement Line.....	People — Patterns 145 to 156.....	513
Overview Scale.....	Percentage Zoom	52
P	Perspective	377
Pan	Constraint	373
Paper	Perspective Correction.....	62, 65, 201, 215, 294
Size	Photo	
Parallel	For PhotoStitch Assistant.....	279, 282
Crosshatch Fill	Remove Background	295
Curved Crosshatch.....	Photochromic Threads.....	72
Parents	PhotoStitch	
Partner	Color.....	277, 289
Partner Connectors	Color Tile.....	278
Paste.....	Linear	278
Block	Monochrome.....	278, 289
Embroidery.....	Sepia	277, 289
Patch Gaps in Pictures.....	PhotoStitch Assistant	277–313
Pattern	Choose and Optimize Photographs.....	279
Fill	Photographs.....	282
Fill Properties	Starting.....	278
Motif Selection.....	Using	283
Satin Area.....	Pick	
Satin Column	Thread Color.....	218, 304
Pattern 36 Satin Effect Fill	Picture	
Pattern Fill	And Thread Color List.....	304
QuickFont	Brightness	84
Pattern Fill Areas	Choose	198, 212, 291
Patterns	Cleaning.....	207
1 to 12 (Standard 1).....	Contrast	84
109 to 120 (Hearts)	Crop.....	200
121 to 132 (Leisure 1)	Gamma	84
13 to 24 (Standard 2).....	Keep Original.....	206, 279
133 to 144 (Mosaic).....	Original.....	226
145 to 156 (People).....	Proportions	207, 280
157 to 168 (Plants & Flowers 1).....	Remove Background	295
169 to 180 (Polygons).....	Rotate	214, 293
181 to 192 (Rope & Chains).....	Save for PhotoStitch.....	301
193 to 204 (Squares 1).....	Scan.....	199, 213, 292
205 to 216 (Squares 2).....	Share	74
217 to 228 (Transport).....	Source	220, 305
229 to 240 (Waves 1)	View	198, 212, 291
241 to 252 (Waves 2)	Picture and Thread Color List.....	218
25 to 36 (Standard 3).....	Picture Options	
253 to 264 (Gradient).....	ExpressDesign	221
253 to 264 (Lace).....	PhotoStitch Assistant	299
265 to 276 (Mosaic).....	Pictures	
37 to 48 (Animals 1)	Dark Borders and Backgrounds.....	209
	For Express Border.....	209

For Express Trace.....	208
For ExpressDesign	206, 208
Patch Gaps.....	208
Stippled.....	209
Piece	
Delete	191
Pre-cut	202, 232, 416
Pre-placed.....	202, 232, 417
Pixel-Thin Lines.....	221
Place Individual.....	169
Place Shape.....	159
Placement	
Appliqué	202
Placement Line	
Match	197, 203, 233, 417
Plants & Flowers I — Patterns 157 to 168	513
Play Demo	72
Play My Demo	72
Point	
Decoration Line.....	159
Nearest	422
QuickFont Joining	422
Ribbon Line	158
Point Appliqué Hole.....	187
Point Appliqué Outline.....	186
Point Select.....	90, 130
Point to Point	
Tiles.....	310
Polygons — Patterns 169 to 180.....	513
PopUp Thread Description	391
Position	
Encore.....	105
Position Slider.....	70
Postscript Type I Fonts	430
Pre-cut Piece	202, 232, 416
Preferences.....	515
Preferred Stitch Type	
ExpressDesign	222
Pre-placed Piece.....	202, 232, 417
Preview	
Design	306
Endless Embroidery	115
Express Border	231
Express Trace	228
Find Outline.....	225
Monochrome Threshold	226
QuickFont	426
Thread Color.....	220, 223, 305
Previews	
Choose Thread Colors	220
Previous.....	427
Split Section	147
Previous Piece.....	190
Previous Section	154
Align To.....	152
Print	517
Information.....	518
Options	149
Range.....	519
Print Catalog	
QuickFont	429
Print Sheet	196
Printed Worksheet	
And Hoop Templates.....	151
Printer	
Print Setup.....	519
Printing	517
Project	
Save Embroidery	147
Save Sections	147
Stitch Out and Align Split Sections ..	150
Project-in-the-Hoop	
Assistant	261
Properties	
Change Frame.....	452
Change Letter	398
Change SuperDesign	442
Curved Crosshatch Fill.....	476
Double Stitch.....	501
Editable.....	462
Font	462
Letter	396
Motif Fill	470
Motif Line	506
QuiltStipple Fill	490
Running Stitch	501
Satin Area	493
Satin Line	504
Stitch Types	462
Triple Stitch	503
Uniform and Non-Uniform	462
Proportional	
Motif Selection.....	509
Tapered Motif.....	499
Proportional Shapes	160, 171
Proportions	
Picture.....	207, 280
Protected Designs	46
Protected Projects	46
Puffy Foam	80
Q	
Quadruple Trace	227
Quality	
Video.....	75
QuickFont.....	384
Assistant.....	401–429
Quilt Block	
Assistant	239–255
Select Size.....	241
Shape.....	252, 257
Style	240
QuiltStipple Fill	490
Quit.....	45
R	
Radial Fill	486
Ramp	380
Range	

And Color Blocks	134	Right Taper	505, 507
Of Stitches	134	Right/Top	
Print	519	Endless Marker	113
Sliders	135	Right-Click Menu	44
Thread	85	Rocket	380
Readme	5	Rope & Chains — Patterns 181 to 192	513
Real Size		Rotate	97
Background	56, 66	45 Degrees	98
Real Size%	427	Handle	87
Realistic 3D	49	Picture	214, 293
Recently Used Embroideries	26	Rotate Picture	
Rectangle Fit To	206	Load Picture Assistant	200
Red		Rotation	
Crop handles	62	Free	98
Red Eye Removal	300	Move Center	98
Redo	124	Rotation Slider	70
Reduce Colors	303	Round Handles	13
Reduce Thick Lines	221	Rounded	374
Reference Guide	4, 540	Rounded Corners	
Release Notes	5	Border	346, 458
Remove		Echo Fill	482
Background	295	Running Stitch	501
Corners Encore	109	Connection	363, 398
Last Bead	177	Connector	146
Overlap	114	Running Stitch Length	203
Overlap When Combining	515	S	
Parts of Photograph	280	Sample Files	5
Photo Background	295	Sans Serif	430
Red Eye	300	Satin	431
Remove a point from curve	372	Border Monogram	350
Remove Background	56, 280, 284, 295	Column	494
Remove From Selection	91	Embroidery On	464, 468, 487, 504
Rename	48	ExpressDesign	222
Repeat Embroidery		Feathered	496
Endless	114	QuickFont	413
Repeats		Tiles	308
Encore	103, 105, 107, 555	Satin Alternative	432
Motif Underline	460	Satin Area	493
Replace Selection	91	Satin Border	415, 420, 432
Reset		Satin Column	494
Remove Background	297	Satin Density	
Reset My Demo	72	Tiles	309
Resize	96	Satin Effect Fill	465, 511
Blue Handles	129	Satin Line	420, 504
Fit To Straight Line Lettering	369	Express Trace	227
Fit To Wavy Line Lettering	369	Saturation	285
Square Handles	87	Color	300
Reveal Groups	93	Save	30, 32
Reverse		All Embroidery Sections	147, 154
Motif Selection	509	Embroideries	30
Revert To	48	Embroidery	147
Ribbon	160	Monogram	352, 354
Ribbon Line		Picture for PhotoStitch	301
Freehand	158	Project Sections	147
Ribbon Selection Dialog	162	Split Project	147, 154
Ribbon SuperDesign	162	Save On Close or Exit	31
Richelieu Bars	497	Scale	96
Right		Design	518
Align	101		

White Handles.....	129	Express Border.....	231
Scan Depth.....	286, 312	Express Trace.....	228
Scan Picture.....	199, 213, 292	Picture Options.....	221
Scanner.....	199, 213, 292	Sepia	
Scroll Bars		PhotoStitch Embroidery.....	277, 289
Hidden.....	18, 52	Sepia PhotoStitch	
Search		Photos.....	282
Font.....	357, 359	Sequin.....	156
Second Color.....	81	Sequin Snow.....	176
Section		Serif.....	430
Align to Previous.....	152	Set	
Project.....	143	Font and SuperDesign Properties....	462
Stitch Out and Align.....	150	Set Background	
Stitching Out the First.....	151	Name.....	67
Select		Set Size	
All.....	89	Background.....	66
Block of Stitches.....	128	Set Stitch Options.....	402, 410
Box.....	90, 129	Settings.....	28, 554
Color.....	217, 303, 554, 556	Monogram.....	352
Embroidery.....	87	Shade Number.....	79
Eye.....	300	Shade Range.....	312
Font.....	323	Shape	
Freehand.....	90, 131	Embellishments.....	159
Multiple.....	88	Encore.....	108
Point.....	90, 130	Quilt Block.....	252, 257, 259
Single Stitches.....	128	Shape Fill.....	484
Select a Series of Stitches.....	128	Shapes	
Select All Visible.....	131	Proportional.....	160, 171
Select Decoration.....	172	Shape Fill.....	484
Select Fabric.....	191	Share Picture.....	74
Select File.....	59	Share Video.....	75
Select Fill Pattern		Sharp Points.....	432
Quilt Block.....	249, 259	Shortcut	
Select Font.....	401, 404	Keyboard.....	558
Select Outline		Show	
Word Sculpt Assistant.....	265	Measurements.....	127, 203
Select Piece.....	189	Show Divider	
Select Quilt Block Style.....	240	Fabric Background.....	64
Select Shape		Side Pieces.....	445, 555
Quilt Block.....	247, 259	Side to Side	
Select Size		Tiles.....	310
Quilt Block Assistant.....	241	Similar	
Word Sculpt.....	265	Arrange.....	111
Select Words		Single Color Gradient.....	466
World Sculpt.....	266	Single Motif	
Selected		Create.....	459
Combine.....	30	Single Stitch.....	128
Selected Designs		Endless Marker.....	113
Grouping.....	91	Single Stitches	
Selecting a motif.....	510	Edit.....	138
Selecting Stitches.....	125	Select.....	128
Selection		Size.....	432
Box.....	87	Constraint.....	373
Font.....	359	Design.....	302
Hoop.....	22	Grid.....	515
Send.....	42	Hoop.....	143
Send Dialog.....	42	Letter Properties.....	397
Send Express to mySewnet™.....	43	Lettering.....	362, 365
Sensitivity		Monogram.....	341

Paper	519	Square Handles	13
SuperDesign	440, 442	Squares 1 — Patterns 193 to 204	513
Size Range	431	Squares 2 — Patterns 205 to 216	513
Slide	379	Stabilizers	151
Sliders	135	Standard	
Slope	379	Encore	105
Small		Standard 1 — Patterns 1 to 12	513
Eraser	296	Standard 2 — Patterns 13 to 24	514
Letter	338, 343	Standard 3 — Patterns 25 to 36	514
Letter Options	349	Standard 3D View	49
Letter Size	334, 343	Standard Appliqué	202, 232, 416
Small Letters		Standard Density	
Alternative Style	343	Pattern Fill	464
Identical Style	343	Start	
Solar Reactive	72	Draw From	135
Source		PhotoStitch Assistant	278
Picture	220, 305	Start Automatically	45
Spacing		Start Point	504, 507
Contour Fill	492	Starting mySewnet™ Embroidery	5
Curved Crosshatch Fill	477	Starting mySewnet™ Machine	44
Echo Fill	483	Stencils	430
Lettering	365, 366, 398	Stiffeners	151
Monogram	341, 351	Stippled Pictures	209
QuiltStipple Fill	490	Stitch	
Special Characters	365	Alignment	145, 154
Enter	365, 559	Colors	423
Not Available in Font	364	Constant Count	96
Special Fonts	362	Contour Fill	492
Specks		Count	268
In Embroidery	299	Curved Crosshatch Fill	478
Speed		Insert Tie	139
Video	76	Modify	135
Spelling		Motif Fill	471
Check	364	Motif Line	507
Spiral		Movement	146
Linear PhotoStitch	311	MultiWave Fill	480
Spiral Fill	487	Options	306
Gradient Density	487	QuiltStipple Fill	491
Spiro		Running	146
Assistant	271	Shape Fill	485
Spiro Assistant	271	Tapered Motif	500
Split		Stitch Angle	
Embroidery	143	Tiles	310
Intelligent	144	Stitch Count	554, 556
Method	144	Stitch Length	
Multipart Hoops	36	Curved Crosshatch Fill	477
Project Assistant	141	Double	203
Straight Line	144	Outline	418
Split Project		Running	203
Assistant	141–152	Stitch Options	
Split Sections		Color Tile	308
Stitch Out and Align	150	Express Trace	227
Square		PhotoStitch	306
Crosshatch Fill	473	QuickFont	410
Curved Crosshatch	476	Spiro Assistant	276
Resize Handles	87	Stitch Out	
Tile Shape	308	Appliqué	233
Square Corners		Appliqué Frame	447
Echo Fill	482	Appliqué Letter	417

Endless Embroidery	117, 118
First Section	151
Foam Frame	448
Order	150
Split Sections	150
Stitch Properties	
Double	501
Running	501
Triple	503
Stitch Type	
Border Options	458
Curved Crosshatch Fill	477
ExpressDesign	222
Full Letter	340
QuickFont	411
Word Sculpt	265
Stitches	
Add	138
Align With Corner or Baste	152
Align With No Alignment	152
Display All	134
Edit	138
Edit Single	138
Insert	138
Removing Strays	298
Select Block	128
Select Single	128
Selecting	125
View a Range of	134
Stop	
Insert	136
Stop Properties	137
Store Demo Point	72
Straight	372
QuiltStipple Fill	490
Straight Line Split	144
Stray Stitches	
Removing	298
Stretch Picture	62, 65, 201, 215, 294
String of Beads	166
Gallery Design	168
Selection	168
Style	
Curved Crosshatch Fill	476
Echo Fill	482
Font	340, 343
Monogram	338
QuiltStipple Fill	490
Sunlight	
Light Reaction	72
SuperDesign	439
Colors	443
Create	438
Edit	441
Properties	442
Size	440, 442
Stitch Properties	462
SuperDesign Window	
Open	438
SuperDesigns	
Different Colors	443
Encore	444
Fix as Embroidery	443
Super-Extended Character Set	406
Surname	319
Surround Options	
Flourish	450
Symbol Fonts	362, 431
T	
Tapered Ends	504, 507
Tapered Motif	499
Technical Information	518
Template	
Hoop	151
Stitch Out	151
Use	150
Terms and Conventions	17
Test Stitch Out of Endless Embroidery	118
Texture	
Endless Embroidery	115
Thick Fabric	464, 468, 487, 504
Thick Lines	221
Thin Fonts	432
Thread	
Change	218, 304
Highlight	391
Photochromic	72
PopUp Description	391
Thread Color	
Change	79, 350
Express Border	231
Express Trace	228
Linear PhotoStitch Embroidery	311
Preview	220, 223, 305
Thread Colors	
Choose	217, 303
Thread Range	
Conversion	85
Threshold	
Monochrome	226
Tie	
Insert	139
Tie Off	
Endless Marker	113
Tile	
Color Embroidery	278
PhotoStitch	290
Stitch Options	308
Tiles	
Shape	308
Stitch Angle	310
Stitch Options	308
Width	308
Tone	
Color	84
Toolbar	9, 552
Customize	9

Tools	
Alignment	101
Top	
Align	101
Trace	
Express	204
Express Options	227
Options	228
Transport — Patterns 217 to 228	514
Triangular Flip Handles	87
Trim	
Connection	363, 398
Insert	137
Triple Stitch	503
Troubleshooting	521
TrueType® and OpenType® Fonts	430
TrueType® Symbol Fonts	362
Twin Needle	80, 81
Size	81
Type	
Encore	105
Typeface	
QuickFont	404
U	
UC Uppercase Font	364
Underlay	
ExpressDesign	222
Pattern Fill	419, 464
Richelieu Bars	498
Satin Area	493
Satin Border	421
Satin Column	494
Satin Columns	414
Satin Line	504
Undo	124
Background Removal	297
Undo and Redo	124
Ungroup	92
Uniform and Non-Uniform Properties	462
Units of Measurement	518
Uppercase Font UC	364
Use	
Other Alignment Aids	151
Template Splitting	150
Use Motifs	
MultiWave Fill	479
Shape Fill	484
Using	
Appliqué	184
Backgrounds	56
Decorations	156
Using and Adjusting Decorations	176
Using Groups	91
Using Name Changer	433
Using Single Color Gradient	467
Using Spiral Gradient	489
Using the Project-in-the-Hoop Assistant	261
Using the Spiro Assistant	271

V

Vertical	
Alignment	101
Line	370
Vertical Hoop with Fabric Moving Up	116
Vertical Mirror	
Quilt Block	246
Vertically	
Distribute	102
Flip Block	100
Video	
Share	75
Video Information	76
Video Title	75
View	
2D	50
3D	49
Embroideries	49
Embroidery Project	147
Life	70
Picture	198, 291
Range of Stitches	134
Realistic 3D	49
Selected Colors	133
Standard 3D	49
View and Print PDF Guides	5
View Picture	212
Visibility	
Background	56
Visible	
Select All	131
W	
Waves 1 — Patterns 229 to 240	514
Waves 2 — Patterns 241 to 252	514
Welcome Screen	7
Western 1 Character Set	406
Western 2 Character Set	407
Western 3 Character Set	407
Western 4 Character Set	407
White	
Handles for Scale	96, 129
Width	554, 556
Font	381
Frame	452
Full Letter	341
Richelieu Bars	497
Satin Border	421
Satin Line	504
Tapered Motif	499
Tiles	308
Width and Height	
Letter Options	362
Letter Properties	398
Motif Selection	509
SuperDesign	440, 442
Window	9
Encore	555
Word Sculpt	

Assistant	264–270	Satin Columns	414
Select Outline	265	Zigzag Width	
Words		Double Zigzag	503
Word Sculpt	266	Zoom	
Work Area	12	By Percentage	52
Worksheet		Choose Thread Colors	305
Color	78	Color Tile Embroidery	310
Project Assistant	149	Color Tone	86
Split Project Assistant	155	Commands	13, 51
Worksheets	149	Design Preview	306
And Hoop Templates	151	Life View	71
Y		Linear PhotoStitch Embroidery	312
Yarn	163	Rotate Picture	294
Yarn Gallery Design	165	Save Embroidery Project	148
Yarn Selection Dialog	165	Zoom Bar	115
Z		Word Sculpt	266
Zigzag	379	Zoom In	51
Double	502	Zoom To Fit	51
Zigzag Underlay		Zoom To Rectangle	51